

# SLEWING BEARING

Rotational solutions where & when you need them

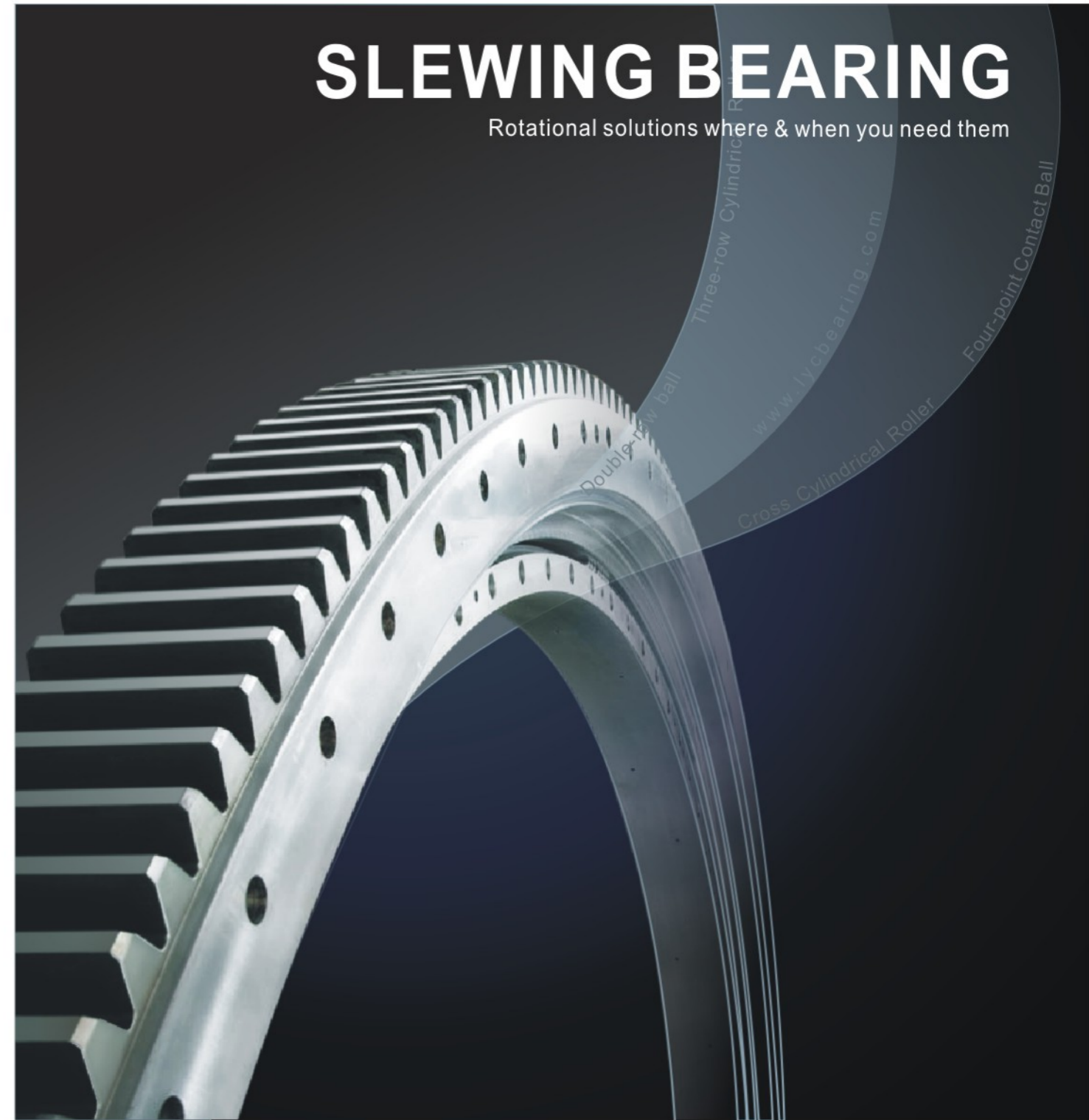





1st Plant  
Jianxi District Luoyang in 1954  
Facility Size:1,000,000 Square meter

LYC Bearing Corporation was established in 1954. The technical expertise has evolved into engaging 3,000 plus engineering personnel and 12,000 manufacturing associates. The product range is divided into nine individual categories, with more than 10,000 different variants, the bearings range extends from ID's of 8mm up to a maximum OD of 6.3 metres. As a world class bearing manufacturer LYC takes pride in their quality and maintain their quality assurance certifications, namely ISO 9001, ISO 9002, ISO 14001, QS9000, and VDA6.1.

LYC Extra-large Bearing Plant specialized in producing slewing bearings. They could produce more than 1500 sizes of slewing bearings with the diameter from  $\phi$  200mm to  $\phi$  6300mm. LYC has more than 40 years successful experience in research and production of slewing bearings, and our design, manufacture and inspection technology of slewing bearings are in the leading position of China, and reach the international advanced level. Slewing bearings with independent intellectual property researched and developed by LYC are widely used in the fields of port machinery, ship industry, metallurgy equipment, aerospace, medical appliance, wind power, construction machinery etc.



2nd Plant  
New park Luoyang in 2008  
Facility Size 667,000 square meters

Construction Equipment



Lifting Equipment



Clean Energy



Ship Building



Offshore Crane



Metallurgy



Mining Equipment



Medical Instrumentation

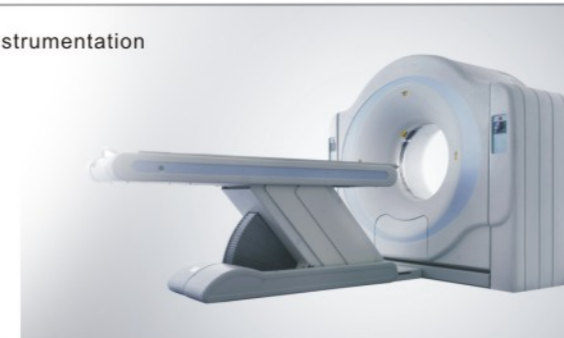

Tunnel Boring Machine



**MAJOR APPLICATIONS  
FOR SLEWING BEARINGS**



## Table of Contents

---

<b>Section 1—Bearing Basic Knowledge .....</b>	<b>001</b>
• Structural Style	
• Designation/Classification Method	
• Selections	
• Material	
• Tolerance	
• Clearance	
• Lubrication and Seal	
• Rust Prevention	
• Installation	
• Operational Maintenance	
<b>Section 2—Four-Point Contact Ball Slewing Bearing .....</b>	<b>025</b>
<b>Section 3—Double-Row Ball Slewing Bearing .....</b>	<b>073</b>
<b>Section 4—Cross Cylindrical Roller Slewing Bearing .....</b>	<b>087</b>
<b>Section 5—Three-row Cylindrical Roller Combined Slewing Bearing.....</b>	<b>115</b>
<b>Section 6—Double-Row Roller/Ball Combination Slewing Bearing .....</b>	<b>151</b>
<b>Attachment—Information Request for Bearing Selection .....</b>	<b>156</b>

© Copyright LYC 2010

The copyright of this catalogue is owned by LYC and may not be reproduced unless permission is granted. Every care has been taken to ensure the accuracy of the information contained in this catalogue but no liability can be accepted for any errors or omissions.

Printed in China







# 1. Structural Style

## 1.1 Basic Terms with Description and Nomenclature

Table 1.1

Designation	Description
b	Tooth width.
d	Inner diameter, refers to the bore diameter of the inner ring of the Slew Bearing with an internal gear.
d1	Center circle diameter of the inner mounting holes.
d2	Outer diameter of inner ring of the inner ring .
da	Addendum Circle diameter.
D	Outer diameter refers to the external column of the surface diameter of the outer ring for a Slew Bearings with an external gear.
D1	Center circle diameter of the outer mounting holes.

### Adding Table

Designation	Description
Dwp	Center circle diameter of the rolling elements, refers to center circle diameter of rolling elements on the main thrust raceway for Slew Bearings with more than two rows of rolling elements
H	Width of the ring without gear, refers to the width of the outer ring for a Slew Bearing with no gear
h	Height difference between upper end face of inner ring and that of the outer ring (mounting place of the Slew Bearing)
m	Module
n1	Number of oil holes within a single row
n2	Number of mounting holes within the inner ring
n3	Number of mounting holes within the outer ring
T	Height of the Slew Bearing
X	Addendum modification coefficient
Z	Number of teeth
$\phi 1$	Diameter of oil hole
$\phi 2$	Diameter of inner mounting hole
$\phi 3$	Diameter of outer mounting hole

### 1.1.2 Basic Terms Component description

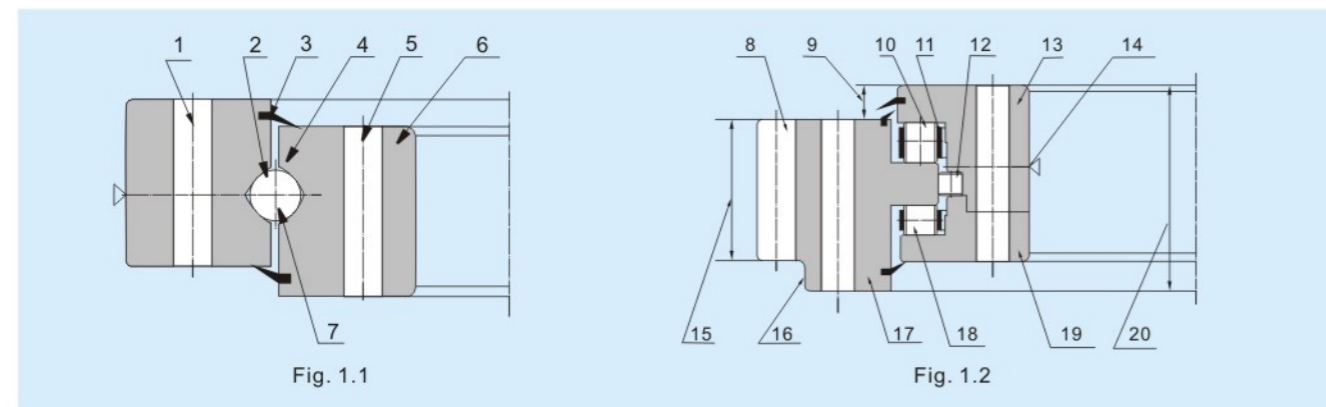

## Radial Bearing

- |   |  |                                    |
|---|--|------------------------------------|
| 1. Center circle diameter of outer mounting holes | 8. Outer gear  | 14. Oil hole                       |
| 2. Rolling elements                               | 9. Height difference between upper end face of inner ring and that of the outer ring | 15. Tooth width                    |
| 3. Seals  | 10. Main thrust rollers  | 16. External surface of outer ring |
| 4. Raceway  | 11. Cage (spacer)  | 17. Outer ring                     |
| 5. Center circle diameter of inner mounting holes | 12. Radial roller  | 18. Minor thrust roller            |
| 6. Inner ring                                     | 13. Main thrust inner ring   | 19. Minor thrust inner ring        |
| 7. Center circle diameter of rolling elements     |  | 20. Overall height                 |

## 1.2 Basic Structures

- Four point contact ball bearing, see Fig.1.3~Fig. 1. 5.
- Cross cylindrical roller bearing, see Fig.1.6~Fig. 1. 8.
- Double row ball bearing, see Fig. 1. 9~Fig1. 11.
- Three row cylindrical roller combined bearing, see Fig.1.12~Fig. 1. 14.
- Double-Row Roller/Ball Combination Slew bearing, see Fig.1.15.

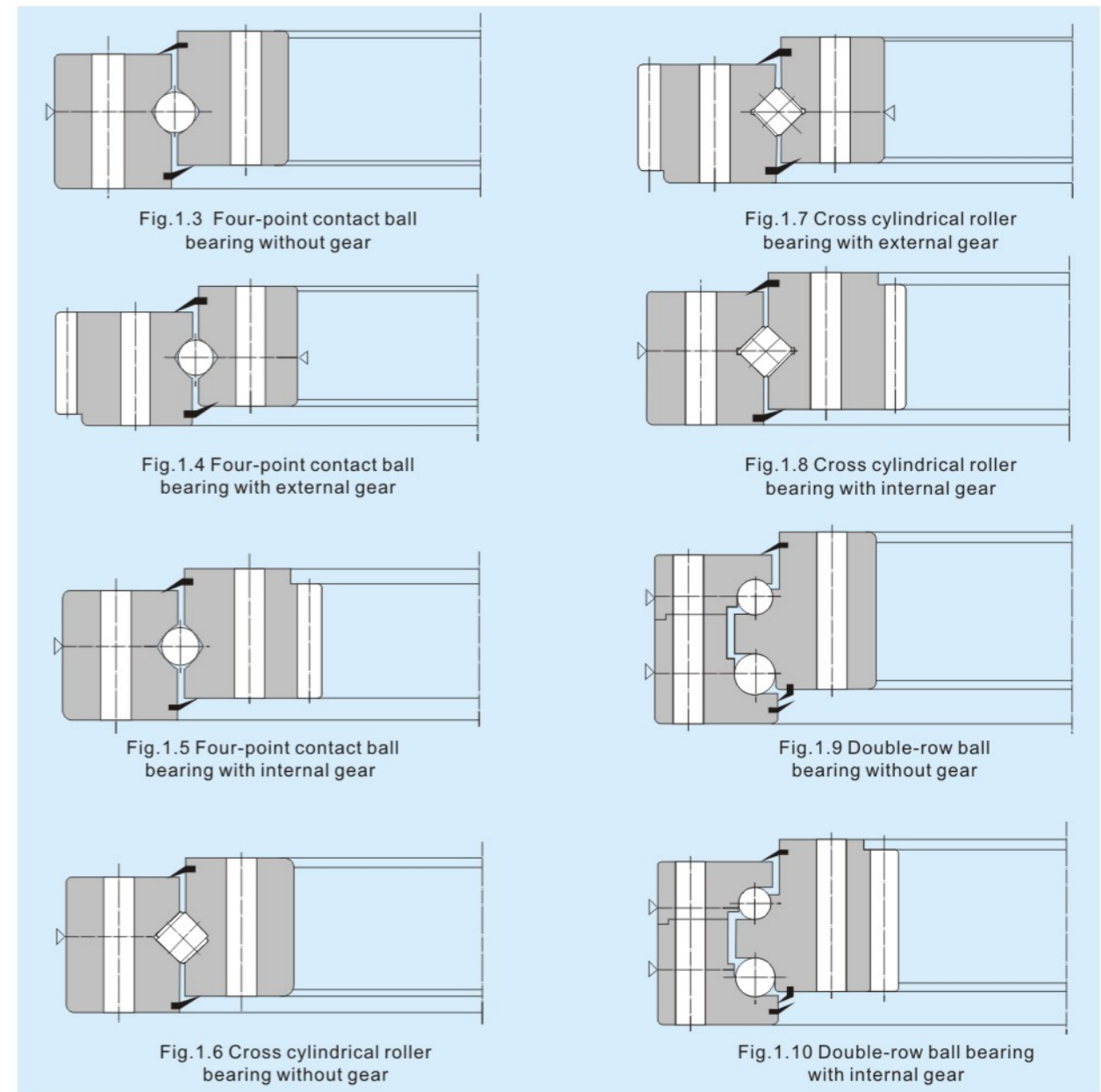



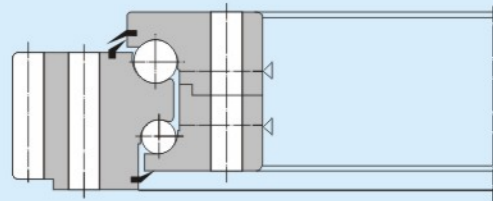

Fig. 1.11 Double-row ball bearing with external gear

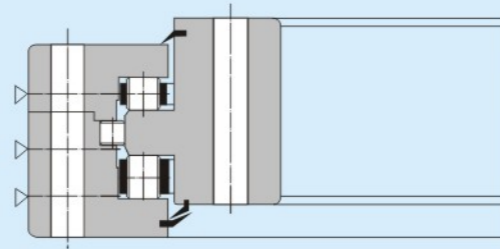

Fig. 1.12 Three-row cylindrical roller combined bearing without gear

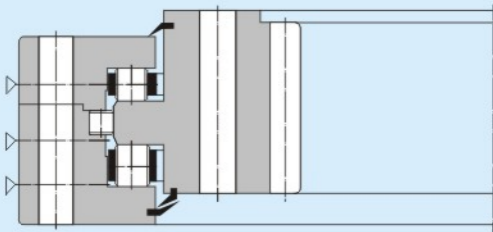

Fig. 1.13 Three-row cylindrical roller combined bearing with internal gear

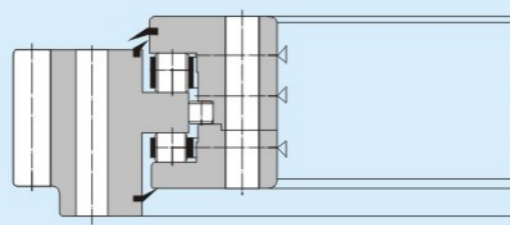

Fig. 1.14 Three-row cylindrical roller combined bearing with external gear

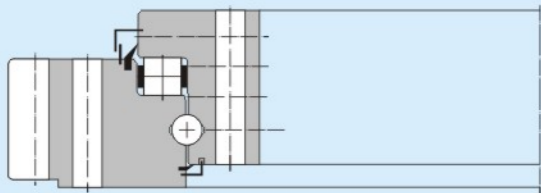

Fig. 1.15 Double-row roller/ball combination slewing bearing with external gear

## 2. Designation/Classification Method

Designation method of LYC slewing bearing has three types:

### 2.1 Method 1

This method is according to the standard JB/T 10471 <Rolling Bearing, Slewing Bearing>

#### 2.1.1 Designation Composition

Bearing designation consists of basic codes and a suffix:

##### 2.1.1.1 Basic designations

The designation is divided into the front section, mid section and the rear section: The front section's code is for the structural style and transmission style, see Table 2.1 - 2.2.

The mid section identifies the diameter of rolling elements, for bearings with more than two rows of rolling elements, It is the diameter of main thrust rolling elements.

The rear section is the center circle diameter of the rolling elements in the main thrust raceway.

When compiling the basic codes, the code of the structural and transmission style are brought together, the front, mid, and rear sections are separated by ".", Please see Fig. 2.1. As an example.

##### 2.1.1.2 Suffix Code

The Suffix code is a supplementary designation for the basic designation, when there is something that has changed from the basic design, for example: in the bearing material, heat treatment methods, tolerances, dimensions, seals and technical requirements etc. See example in Table 2.3.

The material code and heat treatment method are according to Table 2.4. These are separated from basic designation by ".". This representation method is referred to in Fig. 2.1.

Where there are changes in seal, structure variation or technical requirements, it is then expressed by "K+ numerals", such as "K1", "K2". There should be a space between this code and the material code.

The Tolerance classification has three classes, class 0, class 5 and class 6. These codes are separated from the prefix code by "/", the tolerance class 0 is not normally shown.

When gears have a change in their classification, for example when there is a need for teeth to be case hardened etc., it should be expressed by "G + numerals". There should be a space between the code and tolerance code, such as "G 1".

Table 2.1

Code for Structural Design	Designation of Structural Design
01	Four-point contact ball bearing
02	Double-row ball bearing
11	Cross-cylindrical roller bearing
13	Three-row cylindrical roller combined bearing

Table 2.2

Code for Transmission Design	Designation of Transmission Design
0	Without gear
1	Involute cylindrical gear profile with external gear with a smaller module
2	Involute cylindrical gear profile with external gear with a larger module
3	Involute cylindrical gear profile with internal gear and a smaller module
4	Involute cylindrical gear profile with internal gear and a larger module

Table 2.3

Order of Suffix Code (after basic clasifaction)			
1	2	3	4
Bearing material	Seals, structure variation, technical requirements etc.	Tolerance class	Gear change

Table 2.4

Code	03	04	11	12	13
Material	42CrMoT	42CrMoZ	50MnT	50MnZ	Other material

T: material should be quenched and tempered Z: material should be normalized



### Designation Example:

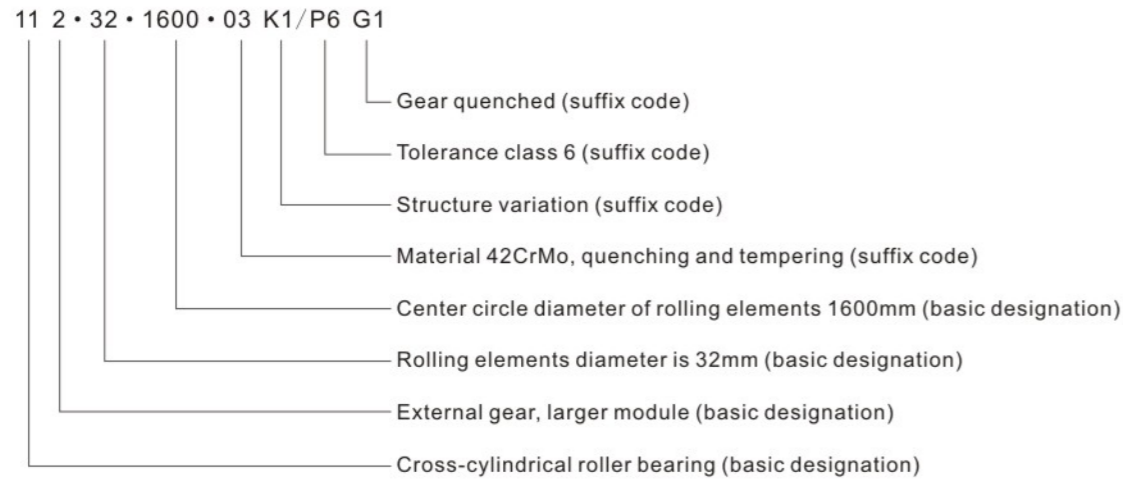

Fig. 2.1

### 2.2 Method 2

This designation method follows the original national standard. It consists of a prefix code, basic code and suffix code. This designation structure is referred to in Table 2.5

Table 2.5

Bearing Designation								
Prefix Code		Basic Code (7 numbers)						Suffix Code
Clearance	Precision Grade	7	6	5	4	3	2	
Expressed by numerals	Expressed by letters	Width Series	Structural Design	Type	Outer Diameter Series	Inner Diameter Dimension	Expressed by letters and numerals	

#### Prefix Code

The precision grade of LYC slewing bearing has three grades: Grade G, Grade E, Grade D. Grade G is generally the standard specification and is not normally shown.

#### Basic Code

The basic Code consist of 7 numbers, the explanation for these numbers are referred to in Table 2.6

Table 2.6

Dimension of Inner Diameter			
Inner Diameter d (mm)	Designation Method	Samples	
		Part Number	Inner Diameter (mm)
<500	1) Expressed by the quotient of dividing inner diameter by 5. 2) When the inner diameter is decimal or could not be divided exactly by 5, it will be expressed by fraction, and the denominator directly indicates the dimension of inner diameter.	79764	320
		797/496	496
		797/488.5	488.5
≥500	Expressed by fraction, and the denominator directly indicates the dimension of inner diameter.	787/800	800

#### Suffix Code

Commonly used suffix codes used in slewing bearing designations are shown in Table 2.7

Table 2.7

Code	Definition
G, G2, ...	In which: G indicates the material of bearing ring example: 5CrMnMo; G2 indicates the material of bearing rings is 50Mn; the material for bearing ring is 42CrMo, when there is no code ...
K, K1, K2...	Classification for nonstandard structure
M	Requirement for friction moment
Y, Y1, Y2...	Changes in Bearing technique
U	Special clearance

#### Sample: E (0) 1792/885 G2 K

"E" -- Precision grade. Grade E.  
 "0" -- Width series, series 0, 0 (maybe be omitted) .  
 "17" -- Structural design, cross cylindrical roller bearing with external gear.  
 "9" -- Type, category 9.  
 "2" -- Diameter series, series2.  
 "885" -- Inner diameter : 885mm.  
 "G2" -- Material, IR and OR manufactured from 50Mn.  
 "K" -- Bearing structure differs from the standard structure.  
 Comparisons between designation method 1 and Designation method 2 are shown in Table 2.8

Table 2.8

Structure	Transmission Design	Without gear		External Gear		Internal Gear	
		Method 1	Method 2	Method 1	Method 2	Method 1	Method 2
Four-point contact ball bearing		010	78000	011/012	178000	013/014	278000
Cross cylindrical roller bearing		110	79000	111/112	179000	113/114	279000
Double-row ball bearing		020	578000	021/022	678000	023/024	778000
Three-row cylindrical roller combined bearing		130	539000	131/132	639000	133/134	739000
Double-Row Roller/Ball Combination Slewing Bearing		—	—	221/222	—	—	—

### 2.3 Method 3

Part of non-standard bearing codes adopt the designation of LYC including "LY or 3", "—" and "bearing type + numerals"

#### Sample: LY -- Q020, definition:

"LY" -- LYC' product brand  
 "Q" -- Bearing type four-point contact ball bearing;

"020" -- Sequence number/serial number, means the 20th product in category Q.

### 3 Selections

Slewing bearings may have multiple structural designs. These designs maintain differing features in performance. Carrying out detailed evaluation in the selection of design will ensure that the bearing's performance meets and exceeds it functional design characteristics.

dimensions (inner diameter, outer diameter, height etc) must be able to guarantee the max load capacity (in addition to a safety factor), service life. Estimation of load capacity and service life should be obtained through factual and theoretical data calculations and application experiences etc. Safety requirement is shown in Table 3.3

then the dimension of vertical orientation (axial direction of bearing) can be adjusted accordingly.

#### 3.1 Considerations in the design selection process

##### Boundary Dimension

The determination of the boundary

In general when the load capacity, service life and safety margins are identified then the boundary dimension of roller element bearing is relatively smaller compared with that of a ball bearing,

When main unit is limited to the horizontal orientation (radial direction of bearing),

#### Load Capacity

Generally, when the rotational diameter and section dimension are same then the static load capacity from high to low is:

- Three-row cylindrical roller combined bearing.
- Four-point contact ball bearing.
- Cross cylindrical roller bearing.
- Double-row ball bearing.

Generally when the dynamic loading capacities are taken into account the



rankings are as follows:  
 Three-row cylindrical roller combined bearing.  
 Cross cylindrical roller bearing,  
 Four-point contact ball bearing.  
 Double-row ball bearing.

Load combination changes are different and can be dependent on installation methods. The common installation methods are referred to Fig.3.1

Seated installation  
 Vertical installation  
 Suspended installation  
 Titles required under each Drg

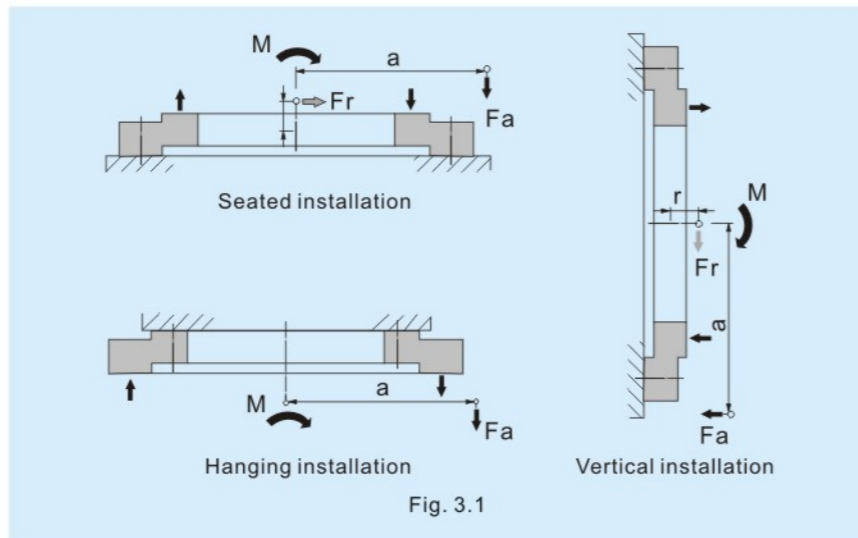

Fig. 3.1

### Friction Moment

Frictional moment can vary within differing slewing bearing designs. In generally ball bearing designs perform better than roller element bearings, also single row bearings tend to perform better than multi-row bearings. The bearing with cage perform better than full-rolling element bearing.

### Transmission Design

Slewing bearings with integrated gears provide the function of transmitting power and can simplify the main structure in most applications within which they are installed.

Bearings with an internal gear location generally facilitate a compact structure, and allow for less contact stress during intermittent momentary operations. These designs result in the least abrasion for the drives within the contact surfaces. Lubrication is easily maintained. External contaminants are generally kept well under control. The protection requirements for meshing are lower than for bearings with external gearing.

External gear structures are more accessible and easily inspected. The manufacturing precision for these designs is higher. And It can maximize the use of frame space .The larger pitch diameter of these gears provide a much larger transmission ratio, whilst at the same time reduce the peripheral

force and torque within the pinion drive.

### Contact Stress

Point contact bearings (ball bearing) have the advantage of low running resistance. To manufacturing variation, installation clearance and bearing frame deformation, ect, they maintain a relative smaller influence on the contact between balls and raceway within the bearing. Under the same load conditions. Point contact stresses are larger than the line contact stress', consequently the load capacity of point contact is accordingly lower than that of line contact.

Contact stress within the line contact is lower compared to that of point contact; its load capacity is larger than that of the point contact. However, the friction resistance generated by the line contact movement is larger than that of the point contact, there are higher requirements in manufacturing accuracy within the bearings frame for these types of bearing. Other important factors are installation accuracy and rigidity, otherwise any deviation from these procedures could result in the generation of high contact stresses, resulting in reduced load capacity, in addition to the potential for premature failure. If the application does not allow for rigidity within the bearing frame then the line contact bearing should not be considered.

### Rigidity

Bearing rigidity refers to the elastic deformation performance of the contact position between bearing rings and rolling elements under functional load conditions. Generally, rigidity of roller bearings is larger than that of ball bearing. Proper bearing preload and the supporting frame with enough rigidity would increase the bearings's rigidity itself.

### Installation

Slewing bearings are generally connected with a supporting frame with bolts so as to ensure rigidity. Mounting holes within the bearing include through holes without thread and blind holes with thread. Through holes are easily installed, and can improve the fatigue strength within the bolts themselves. The other advantage is in favor of machining the holes on the supporting frame work, in addition to the removal of blocking bolts. These advantages provide for these designs to be applied in wide uses.

### Safety

Slewing bearings generally carry larger loads in their weight ratio design, these designs have larger safety factors embedded to ensure that utilization can be applied across a broad spectrum, resulting in satisfying

the load capacity and longevity within the service life

## 3.2 Load Curve

The rotational speed of a slewing bearing is generally slow, therefore, its load capacity mainly refers to the static load capacity. There are several methods of theoretical calculation of the static load, in which the load curve (load—moment) is one of the most common methods used.

Most slewing bearings work under eccentric loading, they also carry

tilting moment loading as well as axial and radial loading. Calculations for loading capacity were previously carried out by manual methods, resulting in being very time consuming and very inefficient. LYC today are using computerized mathematic modeling to provide the load curve calculations across a whole array of extreme applications. The load curve is the allowable load limit for slewing bearing during its working condition, this calculation is the main factor that is used in the selection of any slewing ring.

The modeling takes into account the corresponding points of the equivalent axial load F and equivalent tilting moment M, these are generated from within the calculation form numerous types of load conditions and orientations, analysis of the dynamics within the bearing can be observed at any time. We identify the horizontal axis and vertical axis of load curve, and then make the horizontal line and vertical line of these two corresponding points A. We make an assessment according to the position of point A that whether the design of the static load capacity of the slewing bearing would be able to satisfy the operating requirements or not.

When the position of point A is under the curve 1 and the limit load curve of the selected bolts, the operating requirements of static load are satisfied.

When the position of point A is above the curve 1 and the limit load curve of the selected bolts, the related structure parameters of the slewing bearing needs to be adjusted.

A line connected from the grid origin of load curve via point A is crossed with static load curve 1 at point D. The static load safety factor  $f_s$  of this slewing bearing should be obtained according to the values of the axial load or tilting moment corresponded with point D.

$$f_s = \frac{ED}{AB} = \frac{DF}{AC}$$

Similarly, if the line crosses with the dynamic load curve 2 at point G, and the life load factor  $f_e$  of the slewing bearing could be obtained.

$$F_e = \frac{GH}{AB} = \frac{GK}{AC}$$

Estimated service life  $L_r$  could be obtained according to the factor  $f_e$ .

### 3.2.1 Structure of Load Curve

Structure of slewing bearing load curve refer to Fig. 3.2

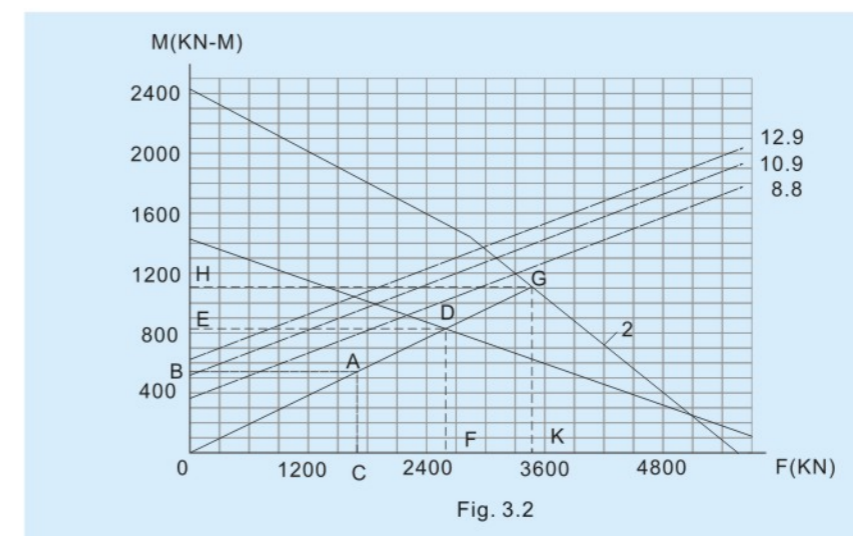

Fig. 3.2

Horizontal axis refers to the equivalent axial load F carried by the slewing bearing, the vertical axis is the equivalent tilting moment M.

Curve 1 refers to the allowable static load capacity limit curve, this shows that material of slewing bearing is 42CrMo, and that the admissible stress is 3850MPa for a point contact and 2700MPa for line contact.

Curve 2 refers to the dynamic load capacity limit curve; this shows that the rating service life of slewing bearing is  $3 \times 10^4$  revolutions.

A set of parallels indicate limit load

capacity curve; this shows that the strength grade of bolts required should be Grade 8.8, Grade 10.9 and Grade 12.9, and that the connection length of bolts are 5 times the nominal diameter of the bolt, these should be pre-stressed at 0.7 times the yield limit of the material.

### 3.2.2 Application of Load Curve

When identify the material selection for the slewing ring, the structural design will be the main parameter, additionally, the heat treatment is also an important aspect. Once again all these load curve calculations are conducted by computer programs.



### 3.3 Selection Calculation

#### 3.3.1 Calculation of Equivalent Axial Load and Tilting Moment

Table 3.3.1

Calculation Method of Equivalent Load and Tilting Moment		
Structural Design	Static Equivalent Load (static state)	Dynamic Equivalent Load (dynamic state)
Four Point Contact Ball Bearing ( $\alpha = 45^\circ$ )	$F_{ao} = Fa + 2.3Fr / Ko$ $Mo = M$	When $Fr > 0.8KcFa$ $F_{ac} = 0.58Fa + 1.18Fr / Kc$ When $Fr \leq 0.8KcFa$ $F_{ac} = Fa + 0.66Fr / Kc$ $Mc = M$
Double row Ball Bearing ( $\alpha = 90^\circ$ )	When $Fr \leq 0.1KoFa$ $F_{ao} = Fa$ When $Fr > 0.1KoFa$ , need to select bearing with the contact angle $< 90^\circ$ $Mo = M$	When $Fr \leq 0.1KcFa$ $F_{ac} = Fa$ When $Fr > 0.1KcFa$ , need to select bearing with the contact angle $< 90^\circ$ $Mc = M$
Cross Cylindrical Roller Bearing ( $\alpha = 45^\circ$ )	$F_{ao} = Fa + 2.3Fr / Ko$ $Mo = M$	When $Fr > 0.67KcFa$ $F_{ac} = 0.67Fa + 1.5Fr / Kc$ When $Fr \leq 0.67KcFa$ $F_{ac} = Fa + Fr / Kc$ $Mc = M$
Three Row Cylindrical Roller Combined Bearing	$F_{ao} = Fa$ $Mo = M$ Radial Load Fr is carried by the rollers carried radial load	$F_{ac} = Fa$ $Mc = M$

$F_a$ — Total axial load carried by bearing, unit is kN.  
 $F_r$ — Total radial load carried by bearing on the plane surface of tilting moment, unit is kN.  
 $M$ — Total tilting moment carried by bearing, unit is kN.m.  
 $F_{ac}$ — Axial equivalent load under dynamic working conditions, unit is kN.  
 $M_c$ — Equivalent tilting moment under dynamic working conditions, unit is kN.m.  
 $F_{ao}$ — Axial equivalent load under static working conditions, unit is kN.  
 $M_o$ — Equivalent tilting moment under static working conditions, unit is kN.m.  
 $K_o$ — Correlation factor of eccentric axial static load and central axial static load (see Table 3.2).  
 $K_c$ — Correlation factor of eccentric axial dynamic load and central axial dynamic load (see Table 3.2).

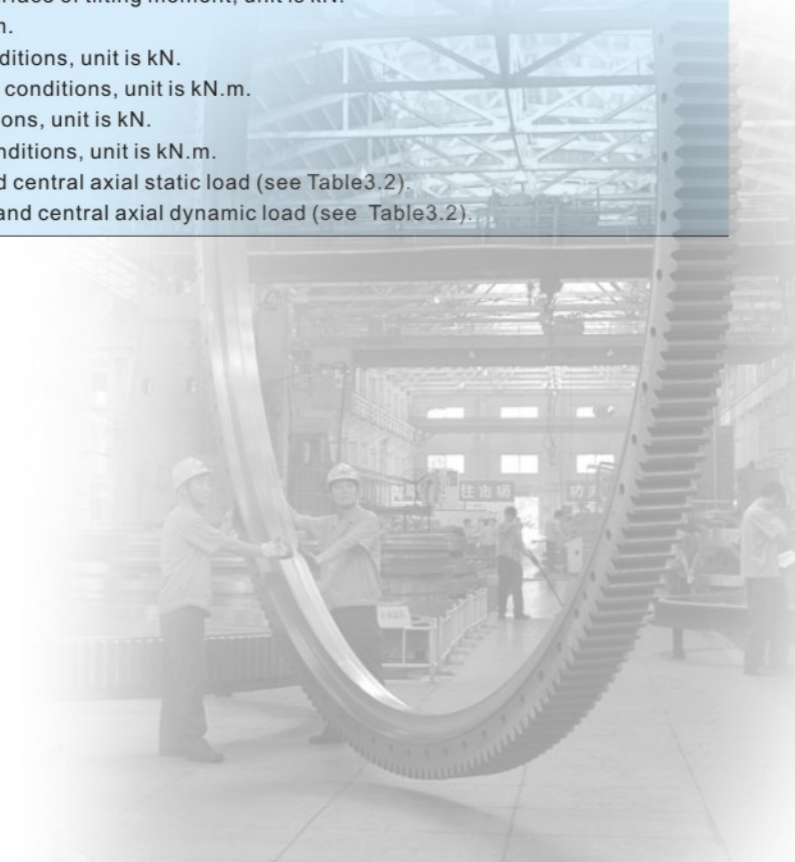

#### 3.3.1.1 Calculation of Equivalent Static Load, Dynamic Load and Tilting Moment under Permanent Load

Table 3.3.1.1

Correlation Factors of the Bearings Eccentric Axial Load and Central Axial Load					
Point Contact			Line Contact		
$\frac{2M}{D_{wp}Fa}$	$K_o$	$K_c$	$\frac{2M}{D_{wp}Fa}$	$K_o$	$K_c$
0	1	1	0	1	1
0.0831	1.168	1.014	0.0611	1.122	1.009
0.1849	1.381	1.064	0.1372	1.276	1.048
0.3080	1.648	1.164	0.2334	1.471	1.134
0.4538	1.983	1.389	0.3600	1.732	1.275
0.6000	2.356	1.501	0.5238	2.076	1.487
0.6317	2.450	1.546	0.5742	2.189	1.554
0.6713	2.564	1.602	0.6341	2.313	1.626
0.7247	2.709	1.675	0.7143	2.483	1.736
0.8005	2.903	1.772	0.8229	2.711	1.872
0.9130	3.178	1.992	0.9763	3.031	2.084
1.0920	3.595	2.152	1.210	3.512	2.376
1.4030	4.303	2.559	1.602	4.318	2.927
2.0460	5.734	3.481	2.391	5.931	4.037
2.2640	6.215	3.735	2.654	6.468	4.423
2.5370	6.817	4.121	2.984	7.143	4.966
2.8900	7.593	4.625	3.408	8.006	5.529
3.3610	8.628	5.389	3.974	9.166	6.377
4.0230	10.081	6.276	4.767	10.776	7.565
5.0190	12.255	7.743	5.926	13.175	9.352
6.6820	15.898	10.227	7.939	17.182	12.357
7.1490	16.920	10.927	8.459	18.387	13.237
7.7100	18.149	11.768	9.114	19.685	14.242
8.3460	19.531	12.719	9.889	21.277	15.443
9.1020	21.186	13.856	10.783	23.095	16.813
10.000	23.148	15.208	11.868	25.316	18.494
11.110	25.575	16.880	13.188	28.011	20.532
12.480	28.571	18.946	14.821	31.348	23.060
14.310	32.573	21.710	16.896	35.587	26.274
16.670	37.736	25.272	19.711	41.322	30.62
20	45.045	30.329	23.810	49.505	36.827

Note: Median value is calculated by linear interpolation method.

#### 3.3.1.2 The calculation of equivalent static load, equivalent dynamic load and equivalent tilting moment under fluctuating load.

The calculation method:

$$F_{a'} = (n_1 \cdot Fa_1^\epsilon + n_2 \cdot Fa_2^\epsilon + n_3 \cdot Fa_3^\epsilon + \dots + n_n \cdot Fa_n^\epsilon)^{1/\epsilon}$$

$$M_{o'} = (n_1 \cdot M_1^\epsilon + n_2 \cdot M_2^\epsilon + n_3 \cdot M_3^\epsilon + \dots + n_n \cdot M_n^\epsilon)^{1/\epsilon}$$

Where

$F_{a'}$ — Equivalent dynamic load under fluctuating load;  
 $M_{o'}$ — Equivalent tilting moment under fluctuating load;  
 $n_1; n_2; n_3; \dots n_n$ — Percentage of working time;  
 $F_{a_1}; F_{a_2}; F_{a_3}; \dots F_{a_n}$ — Axial dynamic load within the percentage of working time, kN;

$M_1; M_2; M_3; \dots M_n$ — Tilting moment within the percentage of working time, kN·m;

#### 3.3.2 Safety factor and life calculation of static load

3.3.2.1 The calculation for the safety factor of static load,  $F_s$ .

$$F_s = F_{aoc} / F_{ao} = M_{oc} / M_o$$

Where

$F_s$  — The safety factor of static load  
 $F_{aoc}$  — The corresponding axial load of the cross point of the connecting line from the grid origin to the static load point and the static load curve, the unit is kN.  
 $M_{oc}$  — The corresponding tilting moment of the cross point of the connecting line from the grid origin to the static load point and the static load curve, the unit is kN.m.  
 The safety factor of static load

The Safety Factors of Static Load Refer to Table 3.3

#### 3.3.2.2 The Calculation for the Life Load Factor fe

$$f_e = F_{acc} / F_{ac} = M_{cc} / M_c$$

Where:

$F_{acc}$  - The corresponding axial load of the cross point between the dynamic load curve and the connecting line from the grid origin to the dynamic load point. The unit is kN.

$M_{cc}$  - The corresponding tilting moment of the cross point between the dynamic load curve and the connecting line from the grid origin to the dynamic load point. The unit is kN.m.

#### 3.3.2.3 Service Life Prediction

Service life prediction under permanent load:

$$L_r = (f_e)^3 \times 3000$$

Where:

$L_r$ — The service life of the bearing when it is fully rotating. The unit is in revolutions( $r$ );  
 $f_e$ — Load factor of bearing life;  
 $\epsilon$ — Life index, for the ball bearing  $\epsilon=3$ , for the roller bearing  $\epsilon=10/3$ .



**Service life prediction under fluctuating load:**

$$L_r = 1 / (n_1/L_1 + n_2/L_2 + n_3/L_3 + \dots + n_n/L_n)$$

Where:

$L_1, L_2, L_3, \dots, L_n$  - The corresponding bearing life within the percentage of working time

**3.3.2.4 Estimation on Peripheral Force of the Gear.**

The estimation of peripheral force after quenching and tempering of the tooth shape:

$$F_n = 0.174mb \text{ kN}$$

Where:

- $F_n$  - Peripheral force;
- $m$  - Module of gear;
- $b$  - Tooth width.

**3.3.2.5 Strength Check of the Mounting Bolts**

In the load curve, the X-axis represents  $F_{ao}$ , Y-axis represents  $M_o$ . The value

of  $F_{ao}$  and  $M_o$  are calculated based on the static working condition. The corresponding point of the cross point in the value of  $F_{ao}$  and  $M_o$  should be below the strength grade curve of the selected bolt.

**Recommendation:**

A bolt with a strength grade of 8.8 can be used in the working conditions, which requires strict and high endurance strength under frequent variable load;

A bolt with a strength grade 10.9 can be used for general building machinery;

A bolt with a strength grade 12.9 can be used in the working conditions, which have a high requirement for the static strength of the bolt under a rating load and yield strength under maximum load, but, may have a lower requirement for fatigue strength.

**3.3.3 Calculation Example**

**Example:** A port gantry crane requires (see Fig 3.3) a ball slewing bearing design, based on the information shown below, then the rotating center diameter would be calculated at approximately 2.5m Dia. The carrying load and moment arm of force are calculated as follows:

**Step 1: Calculating the Total Axial Load  $F_a$  Carried by the Bearing**

Considering the potential situation of overloading the hoisting equipment, a crane load  $1.25Q$  is chosen.

$$F_a = Q + A + O + G \\ = 1.25 \times 196.2 + 67 + 450 + 900 \\ = 1662.25 \text{ kN}$$

**Step 2: Calculating the Total Tilting Moment  $M$  of Bearing**

$$M = Q \times L_{max} + A \times L_1 - O \times L_2 + G \times L_3 + W \times L_4 \\ = 1.25 \times 196.2 \times 23 + 67 \times 11 - 450 \times 0.75900 \times 3 + 27 \times 6.5 = 3515.75 \text{ kN}\cdot\text{m}$$

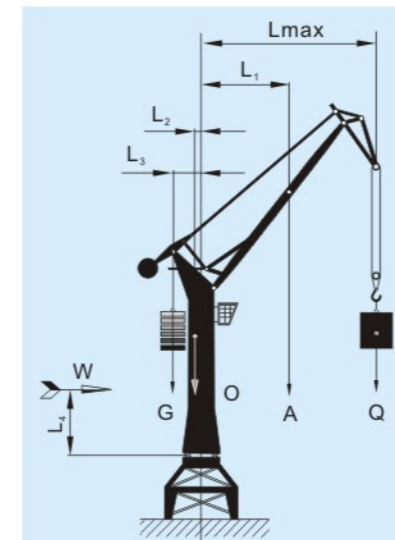

Fig 3.3

- $Q = 196.2 \text{ kN}; A = 67 \text{ kN};$
- $O = 450 \text{ kN}; G = 900 \text{ kN};$
- $W = 27 \text{ kN}; L_{max} = 23 \text{ m}$
- $L_1 = 11 \text{ m}; L_2 = 0.75 \text{ m};$
- $L_3 = 3 \text{ m}; L_4 = 6.5 \text{ m}$

**Step 3: Calculating the Factors  $K_o$  and  $K_c$ .**

$$2M/D_{wp} \cdot F_a = 2 \times 3515.75 / 2.5 \times 1662.25 \\ = 1.692 \\ \text{From table 3.3, we can get } K_o = 4.9462 \\ K_c = 2.9734$$

**Step 4: Calculating the Equivalent Static Load  $F_{ao}$ .**

$$F_{ao} = F_a + 2.3Fr/K_o \\ = 1662.25 + 2.3 \times 27 / 4.9462 \\ = 1674.81 \text{ kN}$$

**Step 5: Calculating the Equivalent Dynamic Load  $F_{ac}$ .**

Only the radial force caused by wind force is considered, but radial force caused by gearing mesh is not considered.

$$\therefore Fr = 27 < 0.8 K_c F_a \\ = 0.8 \times 2.9734 \times 1662.25 = 3954.03 \\ \therefore F_{ac} = F_a + 0.66Fr/K_c \\ = 1662.25 + 0.66 \times 27 / 2.9734 \\ = 1668.24 \text{ kN}$$

**Step 6: Calculating Equivalent Static Tilting Moment  $M_o$ , and the Equivalent Dynamic Tilting Moment  $M_c$ .**

$$\therefore Fr < 0.8 K_c F_a \\ \therefore M_o = M_c = M = 3515.75 \text{ kN}\cdot\text{m}$$

**Step 7: Drawing**

According to the raceway center circle diameter  $D_{wp} = 2.5\text{m}$ , the corresponding bearing load curve can be found within the product catalogue. The corresponding point of  $F_{ao} = 1674.81$  can be found on the X-axis and the point of  $M_o = 3515.75$  can be found on the Y-axis.

Making the horizontal line and the vertical line of  $F_{ao}(1674.81)$  and  $M_o(3515.75)$ , this intersection point A can be seen in Fig 3.4 below. Connecting the line from the grid origin O to the point A and lengthened to curve 1 and curve 2, the two cross points A1 and A2 can be obtained.

Drawing horizontal and vertical lines through the cross points A1 and A2 to X-axis and Y-axis will obtain the following results:

$$F_{aoc} = 2699.98 \quad M_{oc} = 5683.21 \\ F_{acc} = 2532.29 \quad M_{cc} = 5336.62$$

**Step 8: Calculating Safety Factors of Static Load  $f_s$ .**

$$f_s = F_{aoc} / F_{ao} = 2699.98 / 1674.81 = 1.612 \\ \text{From table 3.3 we know the required static load safety factors of the port gantry crane is } f_s = 1.45. \text{ From the result of the calculation, the safety factor of the selected bearing can meet the requirement of the static load safety factor.}$$

**Step 9: Calculating Prediction Service Life of the Bearing  $L_f$ .**

The calculation of the load factor of bearing life  $f_e$ :

$$f_e = F_{acc} / F_{ac} = 2532.29 / 1668.24 = 1.518 \\ \text{From table 3.3, we can obtain the required dynamic load safety factor of the port gantry crane } f_e = 1.16.$$

From the result of the calculation, the load factor of the selected bearing is above the required factor.

$$L_f = (f_e)^3 \times 30000 = (1.518)^3 \times 30000 \\ = 104939 \text{ (revolution)} > 45000 \text{ (revolution)}$$

**Step 10: Selecting Bearings with other Structures, Dimensions and Transmission Types.**

**3.4 Parameters for Bearing Selection**

In order to completely satisfy the requirement of the application, customers are requested to complete the table namely Information Request for Bearing Selection at the last page of this book so as to ensure that all the relevant information has been gathered, this information allows LYC to select the most preferred design for the customer's application.

Table 3.3

Safety Factors of Static Load and Load Factors of Life					
Service Equipment		Safety Factors of Static Load $f_s$	Load Factors of Life $f_e$	Service Life Under Full Rotating $L_f$ (revolution)	
Marine Floating Crane, Automobile Crane, Rotary Table of Grab Type Deck Crane (Continuous rotation is required when using)		1.10	1.0	30000	
Tower Crane for Building	Bearing mounted on the tower	1.25	$M_f \leq 0.5M$	1.0	30000
			$0.5M < M_f < 0.8M$	1.15	45000
	Bearing mounted on the base	1.25	$M_f \geq 0.8M$	1.25	60000
			1.0	30000	
			1.16	45000	
Port Gantry Crane, Marine Crane			1.5	100000	
Crane for Metallurgical Work			1.45	150000	
Automobile Crane (grab type or heavy load hand operation)					
Slewing Crane (grab or suction type)			1.7	300000	
Wheel Crane (grab or suction type)					
Bridge Crane (grab or suction type)			2.15	300000	
Floating Crane (grab or suction type)					
Rope Excavator			1.0	Please consult bearing manufacturer	
Stacker Re-claimer					
Gang Material Conveyor			1.1	Please consult bearing manufacturer	
Railway Crane			1.25		
Small-size Cargo Transporter			1.25	Please consult bearing manufacturer	
Drag line Scraper					
Hydraulic Development Machine	Four-point Contact Ball Bearing		1.25	Please consult bearing manufacturer	
	Other types	Bucket Capacity $< 1.5\text{m}^3$	1.45		
		Bucket Capacity $\geq 1.5\text{m}^3$	1.75		
Ladle Car					

Note:  $M_f$  is the tilting moment under minimum operating range ability.

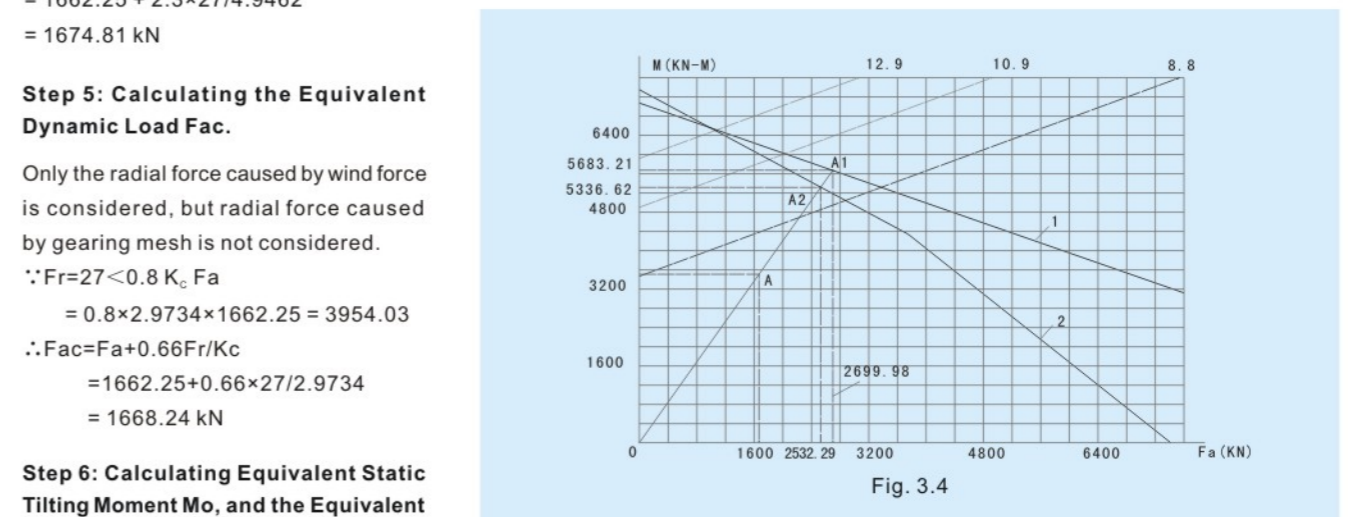

Fig. 3.4



## 4. Material

Careful selection of the type and grade of material is as important as the design so as to guarantee that the bearing maintains a high degree of performance and reliability.

### 4.1 Material for Bearing Rings

The material 50Mn or 42CrMo conforms to the standard GB/T699 <Quality Carbon Structural Steel> or GB/T3077 <Alloy Construction Steel>, these steels are mainly used for slewing bearing rings.

The hardness of the working surfaces such as the raceway surface may have a surface hardness up to 55~60 HRC after hardening, These surface hardness' ensure that the bearing has the desired load capacity.

Other materials, which meet the requirement of service and performance, can also be specified.

## 5. Tolerance

### 5.1 Symbols

The parameter symbols of LYC slewing bearing dimensional tolerance and running accuracy are shown in the following Table 5.1.

### 5.2 Dimensional Tolerance

Dimensional tolerance of LYC slewing bearing conforms to the standard JB/T10471 <Rolling Bearing Slewing Bearing>. See Table 5.2 for dimensional tolerance values.

Please contact LYC technical center if you require other materials besides those already mentioned.

### 4.2 Materials for Rolling Elements

The material for LYC slewing bearing rolling elements, namely the steel balls and rollers are predominately produced from GCr15 or GCr15SiMn, these materials conform to the standard GB/T18254 <High-carbon-chromium Bearing Steel>. The manufacturing quality of rolling elements conforms to the standard GB/T308 <Rolling Bearing Steel Ball>, or GB/T4661 <Rolling Bearing Cylindrical Roller>. The heat treatment specifications are in accordance with the standard JB/T1255.

### 4.3 Materials for Cages and Spacers

According to the performance specification of the slewing ring, the material requirements for both cages and spacers will vary. There are cages

of an integral design type, sectional type, or spacers used as separators for the rolling elements. The main materials used in these areas are 20# steel, aluminum alloy, brass, aluminum bronze, and nylon etc. The performance and quality of the aforementioned materials meet the relative national and international technical standards.

### 4.4 Materials for Seals

Materials for seals are mainly grease/oil resistant and manufactured from nitrile rubber, and fluorine rubber etc. These seals are produced in accordance with the standard HG/T2811 <Material for Lip Type Seal Ring of Slewing Shaft>. Materials of other types can also be used according to the different requirements of customers. Please contact LYC technical center for details.

Table 5.1

Basic symbols	Meaning
$\Delta T_s$	Deviation of a Single Width
$\Delta d_s$	Deviation of a Single Inner Diameter
$\Delta D_s$	Deviation of a Single Outer Diameter
Sia	Axial Run-out of Assembled Baring Inner Ring
Sea	Axial Run-out of Assembled Bearing Outer Ring
Kia	Radial Run-out of Assembled Bearing Inner Ring
Kea	Radial Run-out of Assembled Bearing Outer Ring
Fria	Radial Comprehensive Run-out of Internal Gear
Frea	Radial Comprehensive Run-out of External Gear

Table 5.2

d <sup>a</sup> or D <sup>a</sup> (mm)		$\Delta T_s$	$\Delta d_s^b$			$\Delta D_s^b$		
			Tolerance Class					
Over	Incl.	0, 6, 5	0	6	5	0	6	5
150	400	$\pm 600$	H9	H8	H7	h9	h8	h7
400	630	$\pm 800$						
630	1000	$\pm 1000$						
1000	1600	$\pm 1200$	H10	H9	H8	h10	h9	h8
1600	2000	$\pm 1400$						
2000	2500	$\pm 1600$						
2500	4000	$\pm 1800$						
4000	6300	$\pm 2000$						

a Check  $\Delta T_s$  and  $\Delta d_s$  according to d from the table, and check  $\Delta D_s$  according to D from the table.

b None positioning diameter  $\Delta d_s$  and  $\Delta D_s$  could be according to the stipulation of H12 or h12 separately.

Table 5.4

d <sup>a</sup> or D <sup>a</sup> (mm)		Bore Surface <sup>b</sup>			Outer Diameter Surface <sup>b</sup>			End face		
		Tolerance Class								
Over	Incl.	0	6	5	0	6	5	0	6	5
150	500	2	1.25	1	2	1.25	1	1	0.8	0.63
500	2000	2.5	1.6	1	2.5	1.6	1	1.25	0.8	0.63
2000	6300	3.2	2.5	1.25	3.2	2.5	1.25	1.6	1.25	1

a Check roughness of bore surface and end face according to inner diameter d, and check outer diameter surface according to outer diameter D.

b When bore surface and outer diameter surface with non-positioning diameter can not comply with this table.

### 5.3 Running Accuracy

The running accuracy of LYC slewing bearing is in accordance with the standard

JB/T10471 <Rolling Bearing Slewing Bearing>.

See Table 5.3 for running accuracy.

### 5.4 Surface Roughness

The surface roughness of LYC slewing bearing conforms to the standard JB/T10471 <Rolling Bearing Slewing Bearing>. Please see table 5.4 for the surface roughness.





**Table 5.3** μm

Structure	Running Accuracy	Tolerance Class	D <sup>a</sup> or d <sup>a</sup> (mm)							
			Over	150	400	630	1000	1600	2500	4000
			Incl.	400	630	1000	1600	2500	4000	6300
Four-point contact ball bearing	Sia	0	120	160	200	250	320	400	500	
		6	62	80	100	120	160	200	250	
	Sea	5	45	55	70	90	110	140	180	
		max	0	180	220	280	360	450	560	710
	Kia		6	90	110	140	180	220	280	360
		Kea	5	62	80	100	120	160	200	250
Double-row Ball Bearing	Sia		0	150	190	240	300	380	480	600
		6	75	95	120	150	190	240	300	
	Sea	5	53	67	85	105	140	170	220	
		max	0	210	280	340	420	560	670	850
	Kia		6	105	140	170	220	280	340	420
		Kea	5	75	95	120	150	190	240	300
Cross Cylindrical Roller Bearing	Sia		0	105	140	170	220	280	340	420
		6	53	67	85	105	140	170	220	
	Sea	5	38	48	60	75	95	120	150	
		max	0	150	190	240	300	380	480	600
	Kia		6	75	95	120	150	190	240	300
		Kea	5	53	67	85	105	140	170	220
Three-row Cylindrical Roller Combined Bearing	Sia		0	90	110	140	180	220	280	360
		6	45	55	70	90	110	140	180	
	Sea	5	32	40	50	62	80	100	120	
		max	0	120	160	200	250	320	400	500
	Kia		6	62	80	100	120	160	200	250
		Kea	5	45	55	70	90	110	140	180
Three-row Cylindrical Roller Combined Bearing	Sia		0	250	280	360	400	500	630	710
		6	180	220	250	300	360	480	530	
	Sea	5	140	160	180	220	280	360	400	
		max	0	250	280	360	400	500	630	710
	Kia		6	180	220	250	300	360	480	530
		Kea	5	140	160	180	220	280	360	400

a Check the value of running accuracy for inner ring or outer ring from the table according to the inner diameter d or the outer diameter D.  
b When D or d is not positioning diameter, no requirement for Kia and Kea.

## 6. Clearance

**Table 6.1** μm

Dwp mm	Bearing Tolerance Class					
	0		6		5	
over Incl.	min	max	min	max	min	max
250 450	70	170	50	130	30	90
450 710	100	220	70	170	40	120
710 1120	120	280	100	220	50	150
1120 1800	150	350	100	260	60	180
1800 2800	200	440	150	350	80	240
2800 4500	260	540	200	440	100	300

**Table 6.2** μm

Dwp mm	Bearing Tolerance Class					
	0		6		5	
over Incl.	min	max	min	max	min	max
250 450	25	130	25	90	25	70
450 710	30	170	30	120	30	90
710 1120	40	220	40	150	40	120
1120 1800	40	260	40	180	40	140
1800 2800	60	350	60	240	60	180
2800 4500	80	440	80	300	80	240

### 6.1 The Function of Clearance

To ensure that the bearing is running smoothly, resulting in decreased friction.

To compensate the geometric shape deformation caused by manufacturing tolerances, potential installation error, temperature changes, etc. Prevent lock-up.

To adjust the load distribution.

To acquire the correct contact angle (For ball bearings).

To reduce peristalsis wear and impact (For negative clearance).

To increase the bearings rigidity (For negative clearance).

### 6.2 Clearance Value

Axial clearance of four-point contact ball bearing, see Table 6.1.

Axial clearance of double-row ball bearing (different diameter ball), see Table 6.2.

Axial clearance of cross cylindrical roller bearing, see Table 6.3.

Axial clearance and radial clearance of three-row cylindrical roller bearing, see Table 6.4.

**Table 6.3** μm

Dwp mm	Bearing Tolerance Class					
	0		6		5	
over Incl.	min	max	min	max	min	max
250 450	50	130	30	90	25	70
450 710	70	170	40	120	30	90
710 1120	100	220	50	150	40	120
1120 1800	100	260	60	180	40	140
1800 2800	150	350	80	240	60	180
2800 4500	200	440	100	300	80	240

**Table 6.4** μm

Dwp mm	Axial Clearance						Radial Clearance					
	Bearing Tolerance Class											
	0		6		5		0		6		5	
over Incl.	min	max	min	max	min	max	min	max	min	max	min	max
250 450	30	90	25	70	10	50	50	130	30	90	25	70
450 710	40	120	30	90	15	65	70	170	40	120	30	90
710 1120	50	150	40	120	20	80	10	220	50	150	40	120
1120 1800	60	180	40	140	20	100	100	260	60	180	40	140
1800 2800	80	240	60	180	30	130	150	350	80	240	60	180
2800 5000	100	300	80	240	40	160	200	440	100	300	80	240

## 7. Lubrication and Seal

Provided optimum lubrication and sealing systems is an essential measure to ensure that the bearings are running safely and avoid the potential of early failure.

### 7.1 Lubrication

There are two methods for lubricating the slewing bearings, including oil lubrication and grease lubrication. The grease lubrication method not only provides a lubrication action, but has the additional advantages such as an additional sealing method with good adhesion and simple seal structure and operation, and low cost etc, consequently, this lubrication method is widely used in practical applications.

There are two main sections that require lubrication, namely the interior rolling elements and the external gear lubrication, in some cases there can be differences in the type of lubrication

properties. Some applications may have two types of lubrication, whilst others will maintain a common lubrication. When there are two different lubricants, care should be taken to ensure the correct lubricant is applied to the specific application, during the course of maintenance.

If there are no special requirements from the customer for lubrication, then LYC would not normally lubricate the bearing. Before using, customer could select appropriate lubricants according to the actual working condition.

#### 7.1.1 Lubrication Performance Requirement

Lubrication selections are mainly according to loading, temperature, vibration and working environment etc. Additional considerations should also be taken into account:

- Good performance on high and low temperature range, and preferably waterproof.

- Operating temperature should be 20°C higher than the bearing working temperature.

- Good performance in extreme pressure situations, in addition to antiwear properties.

- Where bearings adopted a centralized lubrication system, then it is important to ensure consistency within the system, so as to maintain a smooth flow of lubricant at any time.

Commonly used grease for slewing bearings include calcium based grease, lithium based grease, and aluminum based grease etc.

#### 7.1.2 Lubrication Period

The slewing bearing's lubrication intervals are dependent on the working condition and environment in addition to the run time. Some recommendations are detailed as below:

- Generally lubrication maintenance should be performed every 150 hours. If under extreme working conditions then this period should be reduced to 50~100 hours. (Typical extreme conditions are high moisture conditions, high temperature, dusty environment, etc)

- If the bearing is scheduled to be out of service for a long period of time, then the bearing needs to be fully filled with lubricant.

#### 7.1.3 Lubrication Methods

Grease should be injected from the respective lubrication holes (the greasing points are generally a screwed hole with the size of M10×1 plug). After greasing, slowly turn the bearing so as to ensure that the grease is distributed evenly.

If there are no special greasing requests, then grease should be inserted within the bearing until grease leaks out from the sealing lip in an even manner.

The lubricating hole can be used as the



intake point or the extract point. When re-lubricating, the old grease should be purged out by new grease that is being injected.

After re-lubrication ensure that lubrication plug is placed back into the grease point. (For individual lubrication point)

## 7.2 Seal

### 7.2.1 Seal Function

- Clean any residual grease from the inside of the bearings seal area.
- Avoid the possibility of any ingress of dust, impurity, moisture to enter the

## 8.0 Rust Prevention

LYC slewing bearings are always treated by rust preventative prior to delivery. The general period for life expectancy for the rust preventative is 12 months.

### 8.1. Packing Material

LYC slewing bearings' packaging materials include:

- Polyethylene/Plastic films
- Polyethylene composite paper
- High strength PVC plastic packing
- Composite plastic weaving belt
- Flax pieces
- Wooden case
- Specialist packaging by customer request

### 8.1.2 Packing

After the rust prevention treatments are applied the slewing bearings are generally wrapped in polyethylene and composite plastic woven belting. Where there are special requirements (such as long distance transportation, high precision or thin section bearing), then a wooden or steel case would be applied as outer package.

## 8.2 Transportation

bearing.

### 7.2.2 Seal Structure

The seal structure for a slewing bearing generally includes a rubber lip seal and metal labyrinth seal. Rubber seals have many advantages, such as their simple structure, small occupation of space, good sealing performance etc.

These are the reasons why they are widely used in varied applications. However, after a long period of time in use, the rubber seal can become brittle

Improper transportation can lead to bearing damage. If improper handling during transportation occurs then this can lead to damaged packaging, fretting wear, surface and internal damage to the bearing. In extreme cases rough handling and poor transportation methods can lead to bearing failure.

Attention to the points detailed below must be adhered to during transportation.

The bearing in most cases should be placed in the horizontal direction whilst in transit. There should be no external force in the radial direction; if this is allowed to occur then deformation of the bearing could occur. If necessary additional supports can be applied in the radial direction within the inner ring so as to avoid radial deformation. see Fig. 8.1 for the purposes of lifting the bearing.

The bearing should be placed in the horizontally when transporting. Anti-slip in addition to anti-vibrate steps should be taken. Bearings should be firmly fixed with ropes/strops. If there is the possibility of inclement weather then the bearings must be covered by waterproof membrane during transportation.

During transportation reduce the possibility of vibration.

and be subject to wear. Higher operating and environmental temperatures can subject seal to early replacement, this should be taken into account in the maintenance scheduling. In extreme applications where rubber would fail in a short space of time then labyrinth seals are adopted.

LYC can design and manufacture special seal structures according to the customer's requirements.

### 8.3 Storage

The slewing bearing is a very large piece of precision machinery and as such should be treated with the greatest of respect. Consequently, LYC request its customers to provide a higher degree of requirement to the storage of slewing rings, as opposed to the storage requirements for general machinery products. Neglect during storing could lead to premature failure after the bearing is installed.

#### 8.3.1 The Requirements for Warehousing

The integrity of the warehousing where a slewing ring is stored can play a vital role in the bearing's performance at a later date. The roof should be sound and not leak, there should be numerous air changes (good ventilation). The slewing ring must not be located in direct sunlight. Placement of the bearing within its packaging should be off the ground, the ground surface should be constructed of concrete so as to avoid rust.

Warehousing should be kept dry. The relative humidity should be controlled under 80%. The temperature should be controlled at  $25^{\circ}\text{C} \pm 10^{\circ}\text{C}$ . High humidity and large temperature swings can lead to the propagation of rust within the

bearing. At lower temperatures the antirust may crystallize and crack, which results in making the rust preventative ineffective. Conversely, at higher temperatures the antirust tends to evaporate resulting in an ineffective rust inhibitor.

Avoid putting corrosive materials such as acid, alkali, and salt being in the same storage area as the slewing ring. Avoid contact with any chemicals, gases, especially any water ingress to the bearing. Avoid storing the bearing in the place where there could be a continuous vibration experienced.

#### 8.3.2 Requirement for Storage

The integrity of the bearing's packaging should be checked prior to been placed into storage. If the bearing's packaging should be found to be damaged, then the bearing should be cleaned and rust inhibitor should be re-applied, the packaging should be repaired or replaced.

All the Product Specification information should be kept in a safe place, so that easy reference can be made to the external information on the packaging.

#### 8.3.3 Stacking Requirements

Slewing bearings should be stacked horizontally. The spacer plate between each ring should be at 100mm distance from the ground (see Fig. 8.2) so as to avoid the potential for corrosion

The stacking quantity in total should not be more than 5 sets of bearings. There should be a minimum of 3 wooden support blocks at 120 degrees spacing to support the weight of each bearing (see Fig.8.2). These blocks should be in the same position within the same vertical stack height. Apply caution when setting bearings in a stack; caution should limit the possibility of damage and the stack falling.

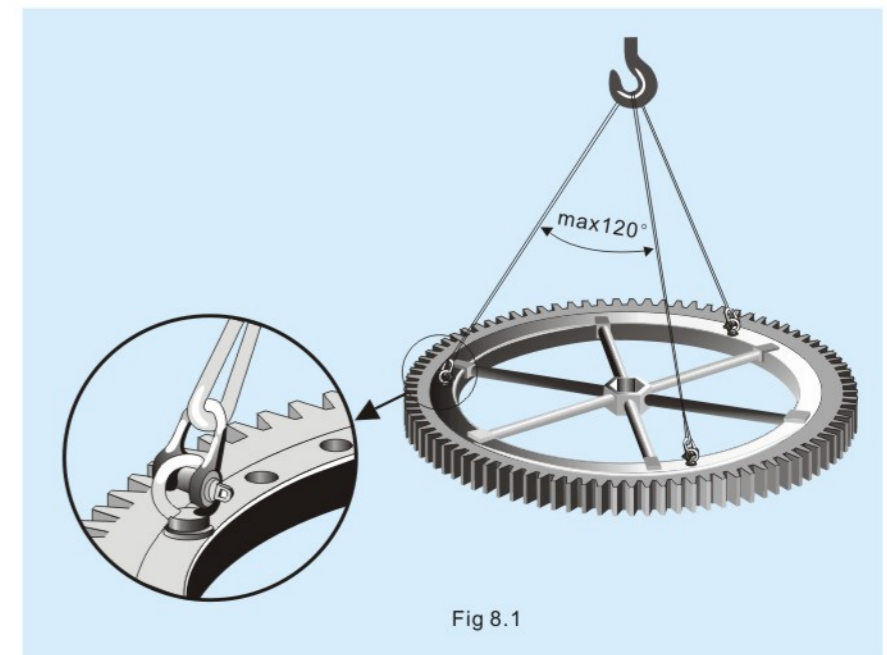

Fig 8.1

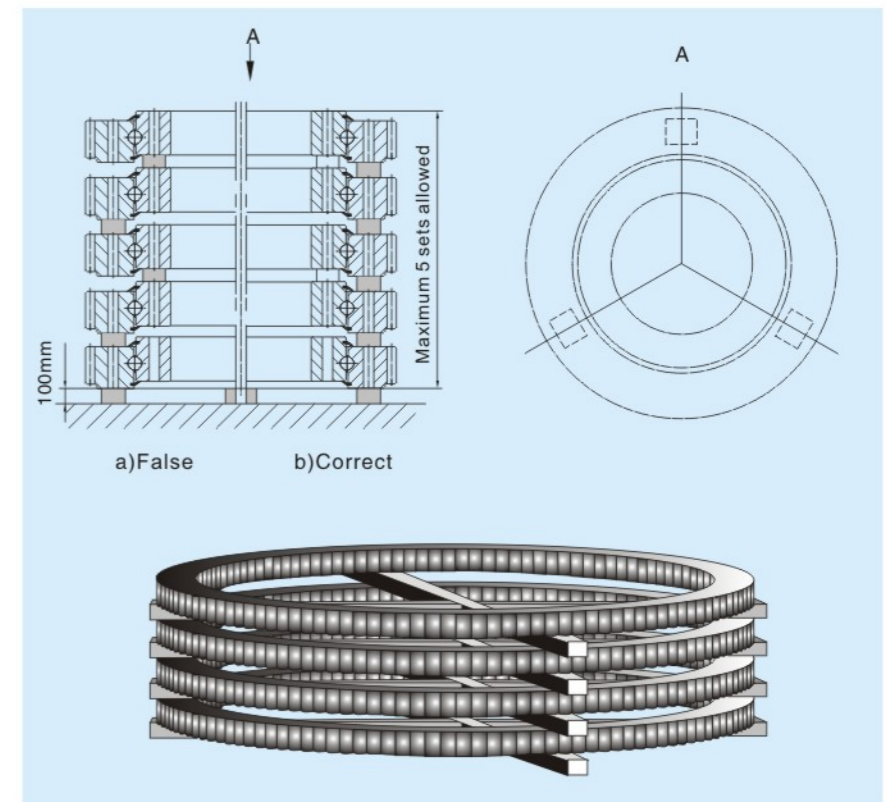

Fig. 8.2



### 8.3.4 Maintenance Period in Storage

The precision of a slewing ring can alter during an extended period of time in storage, consequently where possible, inventory time should be kept to the minimum.

When bearings are kept in storage over one year, the bearings should be removed from their packaging. The rust inhibitor should be removed, and a new coat reapplied. The external packaging should then be reapplied to the bearing. A legible record of what and when this work was carried out should be placed with indelible markings on the external packaging. A record in the bearings master file should also be noted.

also important, if these aforementioned requirements are not followed then this will result in distortion of the bearing, this distortion will have the net result of poor performance and shorten the life expectancy of the bearing (premature failure)

In order to ensure the accuracy (flatness) of the mounting surface, it is recommended that the mounting surface for the support frame work is milled by CNC machining as opposed to being constructed.

If machining is not available, then special plastic fillers with high tensile strength may be used as a gap-filler so as to ensure the precision/integrity of the mounting surface. Please see Fig.

9.1. You may also contact the LYC Technical Department for further advice on this subject.

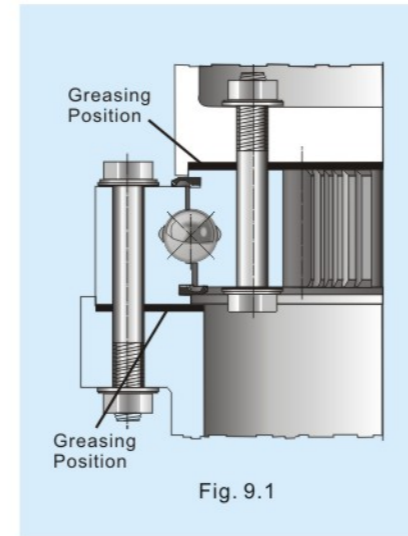

Fig. 9.1

## 9. Installation

The detailed below are the main factors that can influence the normal performance, reliability and the life of a slewing bearing.

- Processing quality (Tolerance Classification)
- Lubrication and maintenance
- Structural rigidity of supporting frame work
- Flatness of the mounting surface
- Bolt quality
- Preload of mounted bolt
- Mounting quality
- Overloading condition and frequency

### 9.1. Mounting Surface

The slewing bearing's design is that of a large and thin section shaped ring. Based on this description it is essential that the slewing bearing be connected to a strong supporting frame work in order to maintain rigidity. If the mounting surface is not flat, then ultimately distortion and warping will occur, similarly the torqueing down of the bolts in the correct sequence is

Table 9.1

Center Diameter of Raceway (mm)		Flatness		
Over	Incl.	Four-point Contact Ball Bearing	Double-row Ball Bearing	Cylindrical Roller Bearing
~	1000	0.15	0.20	0.10
1000	1500	0.19	0.25	0.12
1500	2000	0.22	0.30	0.15
2000	2500	0.25	0.35	0.17
2500	4000	0.30	0.40	0.20
4000	6000	0.40	0.50	0.30
6000	8000	0.50	0.60	0.40

**Note:** The flatness within the above table are the maximum permitted values. Each value should only appear once in the scope of 180 degree. Additionally, any trend that may indicate a steady increase or falling off is not allowed.

Table 9.2

Raceway Center Diameter (mm)		Inclination of Radial Width $\angle$	Roughness Ra ( $\mu\text{m}$ )
Over	Incl.		
~	1000	0.10	2.5
1000	1500	0.12	2.5
1500	2000	0.12	2.5
2000	2500	0.15	3.2
2500	4000	0.20	3.2
4000	6000	0.25	3.2
6000	8000	0.30	3.2

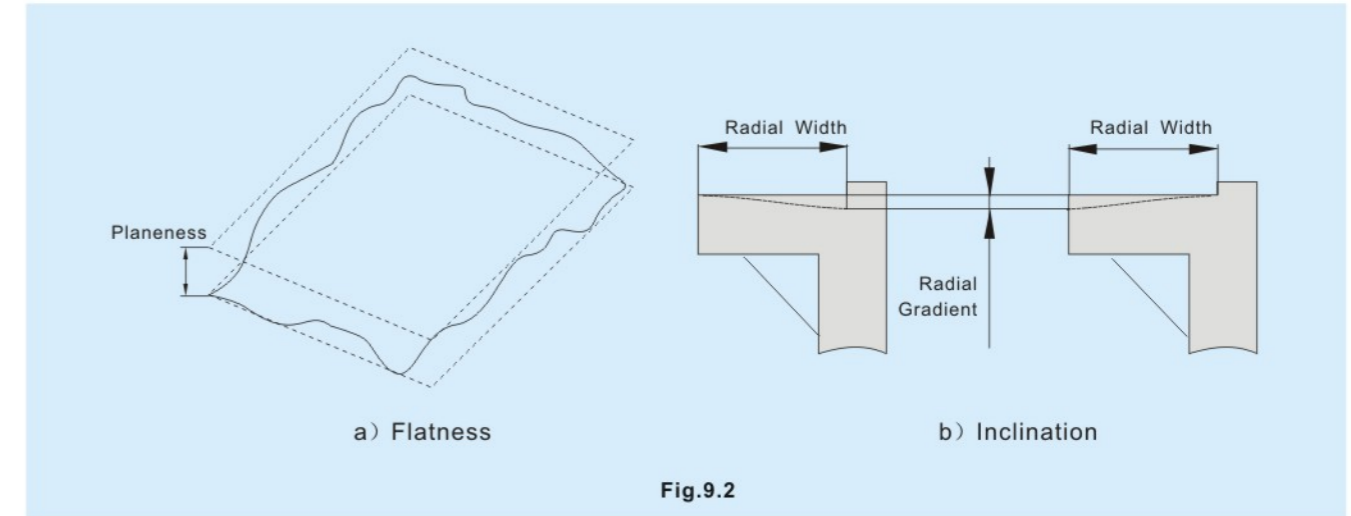

Fig.9.2

### 9.2 Supporting Frame Work

The following issues should be considered when designing the supporting frame work.

The supporting frame work should have enough axial and radial rigidity, otherwise deformation within the axial or radial direction will occur (See Fig.9.3). This will ultimately influence the performance of the bearing in addition to loading distribution, as well as service life.

Table 9.3 shows graphically the deflection that can occur under the maximum allowable loading.

The gauge of material for the mounting plate that may be welded to the supporting frame work should not be less than the values shown in Table 9.4.

The size of the mounting plane for the support frame work must exceed the rotating center diameter and the radial cross sectional dimension of the ring (outer ring or inner ring) in order to carry and transmit loads, which will reduce the possibility of deformation.

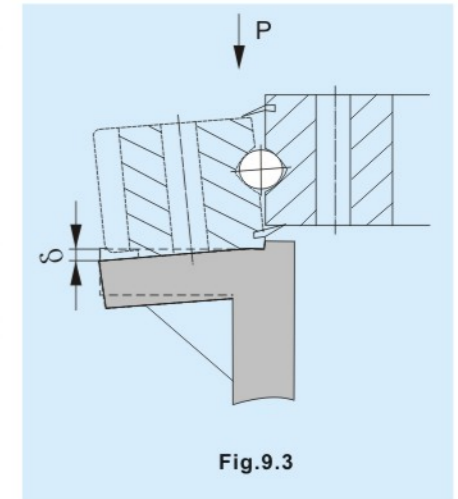

Fig.9.3

Table 9.3

Center Diameter of Raceway		Deflection under Maximum Allowed Loadings	Center Diameter of Raceway		Deflection under Maximum Allowed Loadings
over	Incl.		over	Incl.	
~	1000	0.6	4000	4500	3.0
1000	1500	0.8	4500	5000	3.6
1500	2000	1.0	5000	5500	4.2
2000	2500	1.3	5500	6000	4.8
2500	3000	1.6	6000	7000	5.8
3000	3500	2.0	7000	8000	7.0
3500	4000	2.5			

When the radial load of the bearing is 10% higher than that of the axial load, then the radial location at mounting plate of the supporting frame work must be considered, so as to prevent radial displacement after carrying the

load. When considering the position of the spigot the radial position should not be more than half of the tolerance within this zone. Except for special circumstances, welding is not allowed on or near the

Table 9.4

Center Circle Diameter of Rolling Elements		Min. Thickness mm
over	Incl.	
	500	25
500	750	30
750	1000	35
1000	1250	40
1250	1500	50
1500	2000	60
2000	2500	70
2500	3000	85

bearing location. If welding were performed, then this could result in heat being transferred to the bearing, with the net result that the bearing could be deformed or change the hardness within the material.



### 9.3 Bolt

Bolt sizes should meet the requirements of GB/T5782 and GB/T5783, the mechanical properties should be not less than grade 8.8 as stipulated in GB/T3098.

Nut sizes should conform to GB/T6170 and GB/T6175, the mechanical property should meet the requirement of GB/T3098.2.

Washer sizes should meet the requirement of GB/T97.1 and GB/T97, washers are required to be quenched and tempered.

Spring washers are not to be used in a slewing ring installation.

A preload should be applied to all bolts. With the exception of special circumstances the preload should be 0.7 times of the yield limit of the bolt. Preloads are shown in Table 9.5.

The bolt's clamping length must be 5

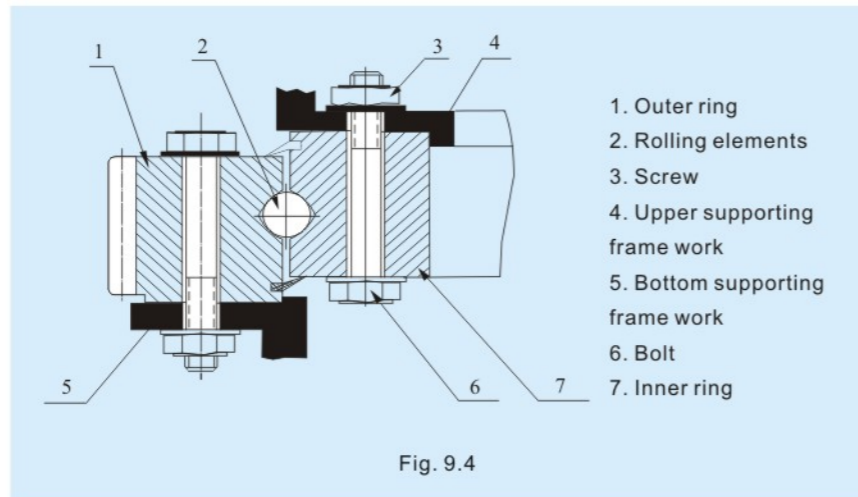

Fig. 9.4

times the bolt diameter.

### 9.4 Installation Requirement

The following requirements need be met when carrying out installation

Prior to installation do not open the outer or inner packaging, this will avoid the ingress of dust or water into the bearing. Carrying out installation and lubrication within a short period of time once the bearing is removed from the packaging.

Pre-prepare the mounting plane of the

supporting frame prior to installation. It is essential to ensure the removal oil stains, burrs or any other debris that may affect the mounting of the bearing. See Fig.9.5

Prior to installation, check whether the bearing meets requirements, such as appearance, rotating status, running accuracy, clearance (see Fig.9.5), rotating flexibility, seal, mounting location, and lubrication, etc.

The slewing bearing has a soft zone marked with an "S" on the upper surface, when installing the bearing it is important to ensure that this area is placed in a non-load or infrequent load zone (The load plug is always located in soft zone), see Fig.9.7

When the bearing is placed on the supporting frame work, it is important to check the interface between these two surfaces. The checking should be carried out with the insertion of feel gauges between the two surfaces. If a gap should exist then it is recommended to plane/resurface the effective area so as to remove the gap. If machining is not practical, LYC allow the use of special plastic fillers with high tensile strength or the use of high tensile shims. The use of filler or shims are to prevent the bearing from suffering deformation during the lock down process with the bolts.

The axis within the mounting holes on

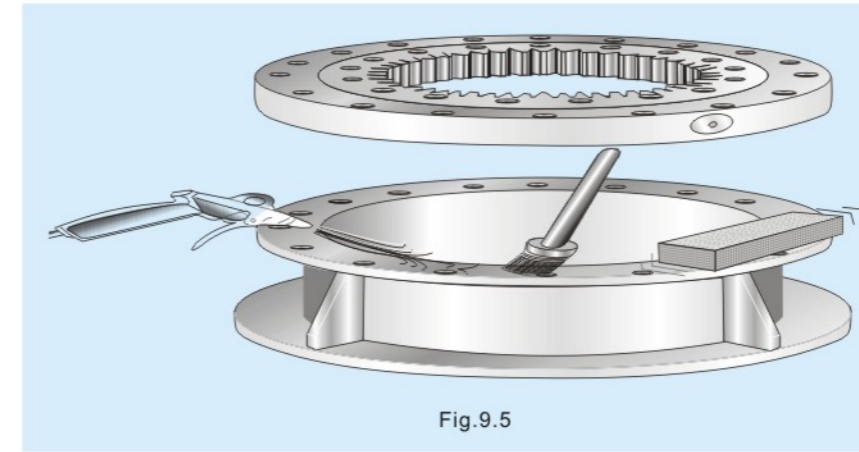

Fig.9.5

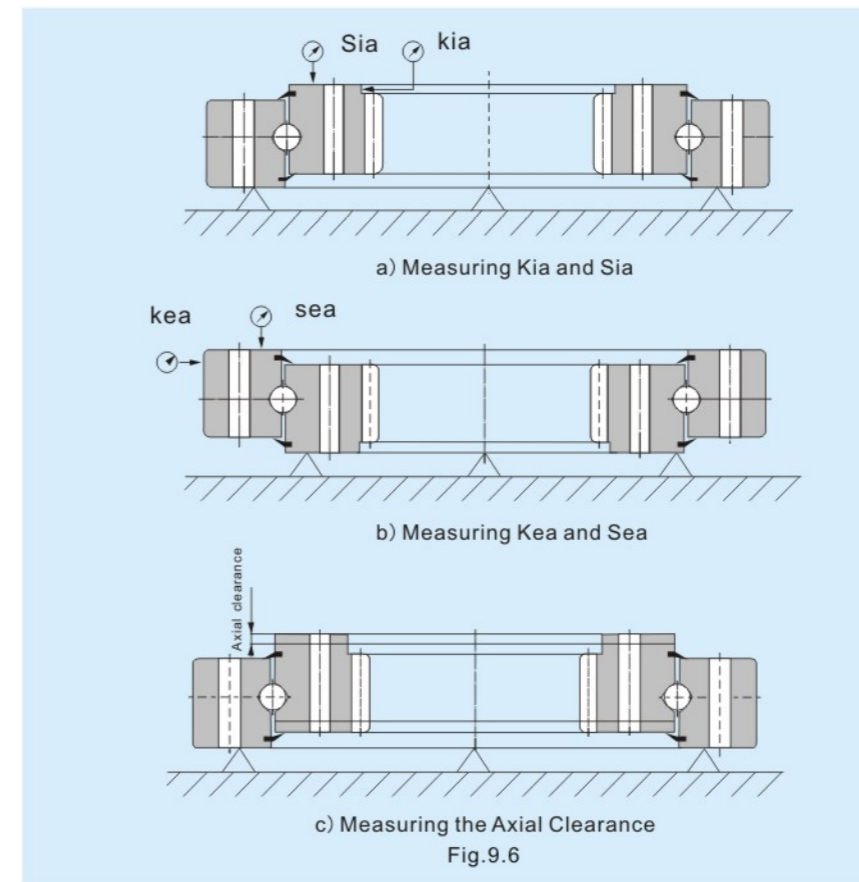

Fig.9.6

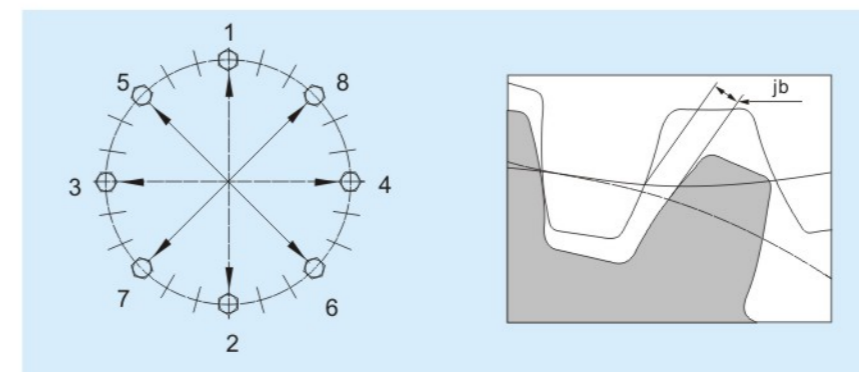

Fig. 9.9

Fig. 9.10

the mounting plane should maintain alignment with that of the bearings mounting holes. When adopting oil lubrication the location of oil intake port should be given careful consideration.

All bolts are required to be tightened evenly as shown in Fig 9.8. The sequence of this tightening process is shown in Fig 9.9. The preload to the bolts should be applied as reviewed in section 9.3 and reference to table 9.5.

Welding is not allowed on bearing. In case of welding of adjacent parts, heat transfer shall be avoided so as not to cause bearing to become deformed or hardness changing.

When bearings are supplied with a gear drive, it is essential to ensure rotating stability and good gear meshing. The mesh accuracy such as the contact length needs to be measured; backlash (see Fig.9.10) should also be checked before completely tightening the bolts.

Check the clearance between the bearing and fitting surface of supporting frame work, if a gap should exist (see Fig.9.11), then this must be rectified.

After installation, the bearing should be rotated to check for smooth operation and any emission of unusual noise. If either of these two are noted, then the bearing should be adjusted to eliminate them.

When equipment is frequently operated outdoors, precautions should be taken to avoid water ingress.

Where the application is operating in a corrosive environment, it is recommended to carry out surface treatment of the bearing, such as aluminizing, zinc spraying, spray painting, or phosphate. These types of protective coatings will ensure the longevity in performance.

Table 9.5

Bolt Strength Grade	8.8	10.9	12.9
Yield Limit (N/mm <sup>2</sup> )	640 (M≤16), 660 (M > 16)	940	1100
Bolt Diameter	Preload (kN)		
M10	26	38.5	45
M12	38.5	56	66
M14	53	77	90
M16	72	106	124
M18	91	129	151
M20	117	166	194
M22	146	208	243
M24	168	239	280
M27	221	315	370
M30	270	385	450
M33	335	480	560
M36	395	560	660
M39	475	670	790
M42	542	772	904
M45	635	905	1059
M48	714	1018	1191
M52	857	1211	1429
M56	989	1408	1648
M60	1156	1647	1927



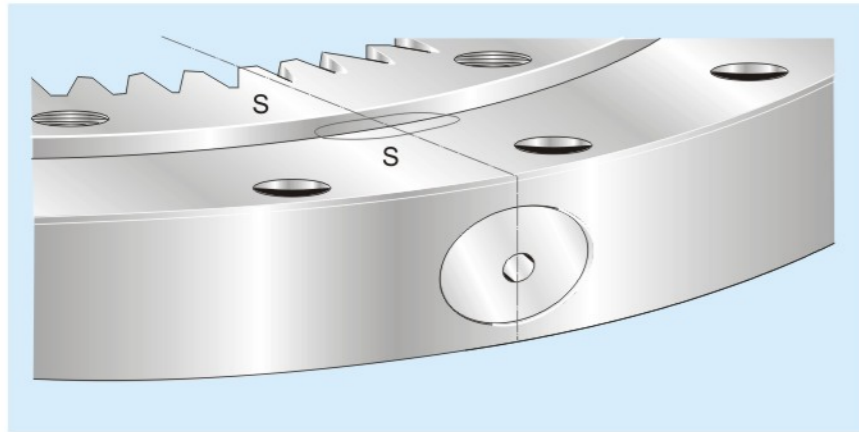

Fig.9.7

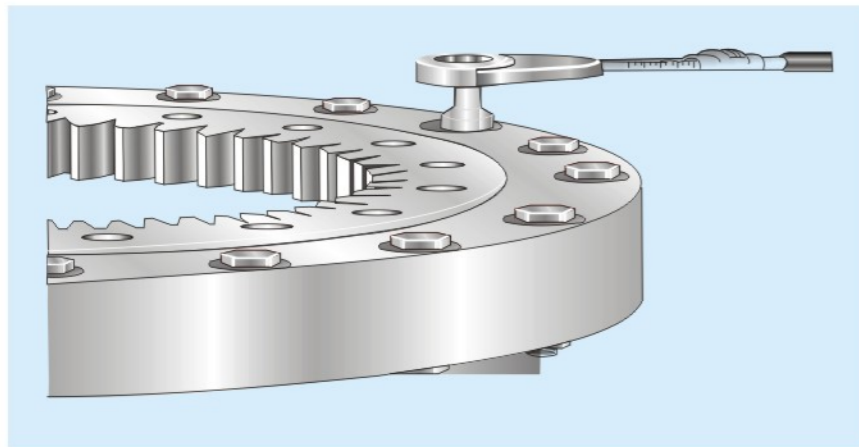

Fig.9.8

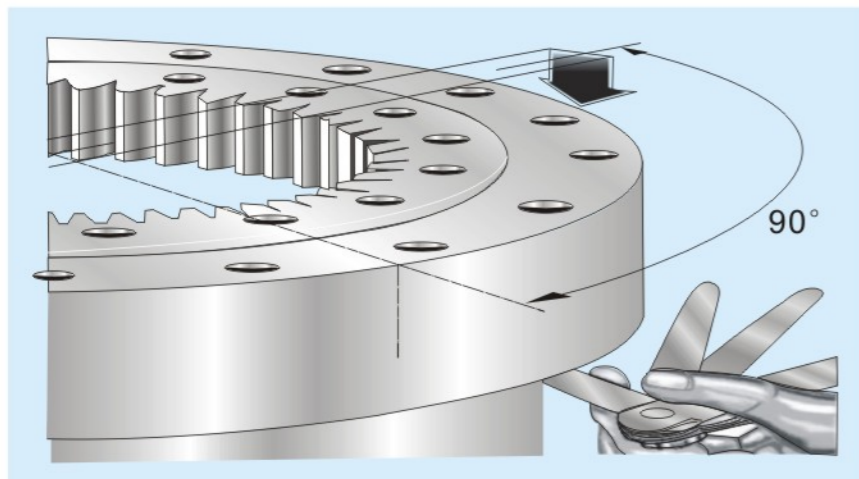

Fig.9.11

## 10. Operational Maintenance

Scheduled maintenance is essential so as to ensure that the bearing operates at optimum performance and is able to achieve its calculated life expectancy. Maintenance is generally divided into two sections. The first section being after the bearing is mounted and has passed the run in period, the second section named routine maintenance is the period after the bearing has entered into normal operation.

The first section of maintenance is generally carried out after the bearing has been running 100 hours. Particular emphasis at this inspection period is to clean the tooth surface and seal, check mesh precision and re-torque the bolts.

The second section for maintenance is divided into routine maintenance and periodic maintenance.

Routine maintenance is performed prior to the equipment being started. It includes checking for abnormal noises, vibration checks, electric current changing or power discharge in the case of electrical equipment. If there should be abnormal or unusual noises identified then the equipment should be stopped and checked immediately.

Periodic/scheduled maintenance should be according to the workload of the equipment's environmental conditions in addition to other factors. Under normal circumstances this schedule should be carried out every 500 hours. The bearing should be checked prior to periodic maintenance, if anything unusual i.e. noise, appearance, or if the running condition should deteriorate etc. Bearings must not be opened without the expressed consent of LYC.

Please see below the content and measurement for maintenance in Table 10.1

Table 10.1

Part	Inspection Content	Measurements
Bearing	1. If any unusual vibration has been detected (abnormal change while running).	1. Whether there is any interference between adjacent parts and the bearing. 2. Replace the contaminated lubricant or the failed seals. 3. Inspect the internal components of the bearing, only under the instruction of the bearing manufacturer.
	2. If there are any abnormal changes in the sound of the Bearing while running.	1. Adequate lubrication. 2. Flush and change the contaminated lubricant or failed seals. 3. Check the internal components within the bearing, only under the instruction of the bearing manufacturer.
	3. If increased resistance is noted.	1. Remove the clearance or the deformation between bearing and the pillow block.
Gear	1. Backlash.	1. Adjust the center distance between the two gears when the backlash is unsuitable.
	2. Contact length or width.	1. Adjust the deflection between the bearing and pillow block when the length and width are uneven.
	3. Lubrication.	1. Remove the contaminated lubricant, and re-lubricate. 2. Added lubricant.
	4. Wear on tooth surface.	1. Eliminated the bumps, scratch, and dirt caused by the surface wear.
	5. Foreign material at the root of teeth.	1. Eliminate the foreign material.
Bolt	1. Loose bolt.	1. Re-torque loose bolt. 2. Check bolt torque every 500 hours.
	2. Install surface joint clearance between bearing and supporting frame work.	Remove the clearance.
	2 Fracture.	Replace the bolt.
	3. If there is any deformation of the washer.	Replace the bolt and washer.
Seals	4. Fatigue.	Replace the bolts which have been used for 7 years or 14,000 hours or more.
	1. Breakage, ageing,	Replace the seal.
	2. Excessive stretching, dis lodged.	Adjust or re-install replacement seal.
	3. Seal lip broken.	1. Replace the seals that are aged or worn. 2. Add lubricant to the seal lip.
Lubrication	4. Contact condition between bearing and seal lip.	1. Clean the contact site. 2. Remove the sharp edge from the friction position.
	1. If there is any abnormal leakage of the lubricant.	1. Added fresh lubricant or change the expired lubricant. 2. Replace the broken seal. 3. Eliminated the bumps, scratches or dirt from the surface between the bearing and seal lip.
	2. Lubricant contaminated.	1. Replace seriously contaminated lubricant. 2. Replace the failed seal.
	3. Failure not identified.	1. Replace the seal.



### Four-point Contact Ball Slewing Bearing

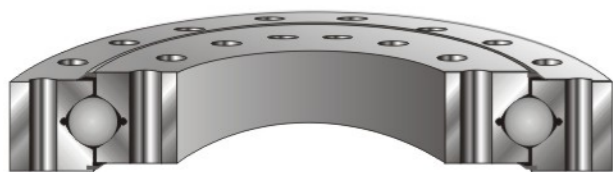

Type 010 (Type 78000)

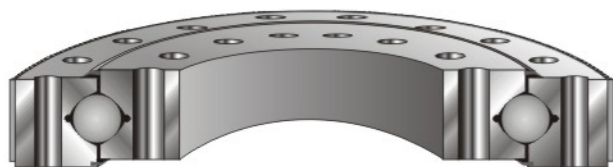

Type 011/012 (Type 178000)

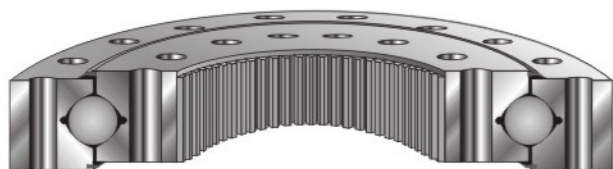

Type 013/014 (Type 278000)

▲ The design's of all these slewing rings are based on standard structures; LYC can design and manufacture many other similar structures in accordance to the special and particular requirements of their customers'. If our customer's have specific requests then the customer should identify the structure, and mounting dimensions that are required. Please contact the LYC Technical Center if you need any assistance in this area.

### Four-point Contact Ball Slewing Bearing

LYC four-point contact ball slewing bearing can carry axial loads, tilting moment and radial loads all at the same time. Almost all steel balls will carry load under the combined action of axial load and tilting moment load. Steel balls are in contact with the raceway of outer ring and inner on a single-point when carrying pure axial load.

When radial loads exceed a certain value there would be two points respectively for the contacting balls within the outer and inner raceway. Meanwhile, wear and friction moment would be large. The tilting moment and radial force loading in any kind of working conditions allow the contact angle to be adjusted accordingly.

LYC four point contact ball slewing

bearing in the main consist of a inner ring, outer ring, a single row of steel balls, and a cage (or spacing block).

LYC four point contact ball slewing bearing inner ring, outer ring have integral and split structure. The rigidity of the integral rings is relatively good in holding its rigidity. The split structure is fastened by bolts, this facilitates for a more convenient adjustment process.

Normally LYC four point contact ball slewing bearing have cages (or spacing blocks). The full ball type has a larger load carrying capacity. In some situations this type would be selected for heavy loading applications. However, this design has a high frictional resistance, this could cause nicks on ball surface.

The mounting needs will suit mounting holes that are designed as straight hole, counter hole, thread blind hole, or thread through hole and etc.

This contact ball design slewing bearing is suitable under axial load, tilting moment and small frictional resistance applications. The contact mounting surface must have adequate radial rigidity.

The basic structures of LYC four-point contact ball slewing bearing as below:

- Without gear (Type 010)
- External gear (Type 011/012)
- Internal gear (Type 013/014)

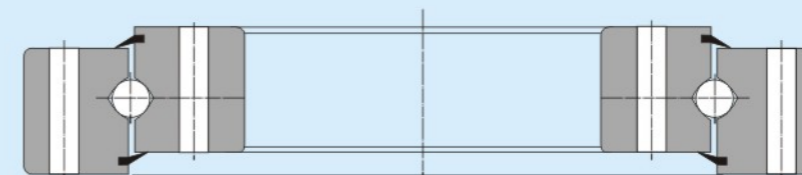

Type 010 (Type 78000)



Type 011/012 (Type 178000)

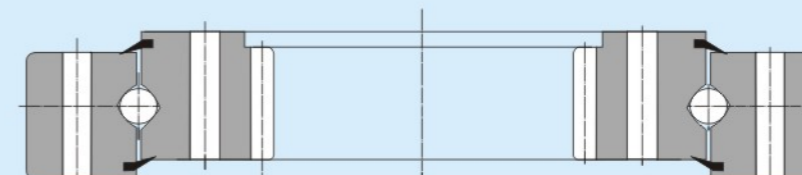

Type 013/014 (Type 278000)



### Four-point Contact Ball Slewing Bearing-with Internal Teeth

d235~1400mm

Boundary Dimension			Bearing Type	Related Dimension										
d	D	T		D1	d1	d2	H	h	Dwp	n1	n2	n3	φ1	φ2
mm			mm											
235	380	54	013.20.310.12	358	259	309	44	10	210	1	12	12	M10×1	M12
--	456	57.5	2787/327	490	375	413	46	11.5	413.5	4	12	8	M10×1	M12
450	654.8	92	278790G2	626	478	545.8	90	2	547.5	2	8	8	M10×1	M8
458	662	80	014.30.560.12	626	494	558.5	70	10	560	4	20	20	M10×1	18
512	741.0	80	D2787/512	705	550	619	66	14	627	4	14	24	M10×1	24
--	748.0	56	2787/546G2	720	605	642	56	10	644	4	18	12	M10×1	M10
601.5	735.8	52	D2787/575	712.5	625	663.0	45	7	668	2	18	18	M10×1	1/2
608	812	80	013.30.710.12	776	644	704	70	10	710	4	24	24	M10×1	18
--	896	68	013.25.800.11	858	742	800	58	10	800	2	20.0	20	M10×1	M16
678	922	100	013.40.800.12	878	722	798.5	90	10	800	6	30	30	M10×1	22
720	900	70	LY-Q035	860	750	808	50	--	812	6	36	36	M10×1	M10
720	900	70	LY-Q035K1	860	750	808	50	10	810	6	34	36	M10×1	M10
781	1022	105	013.30.900.03K/P5	978	825	899	90	10	900	6	30	30	M10×1	18
794	1008	78	013.25.900.12	964	836	900	68	10	900	2	20	20	M10×1	22
--	1200	90	2782/922G2	1160	1015	1086	80	10	1087.5	4	12	12	M10×1	M8
875	1170	95	013.32.1020.11	1120	930	1020	80	15	1020	4	24	24	M10×1	22
975	1250	150	2787/975	1210	1015	1102	133	17	1100	6	30	29	7	M20
--	1198	59	2787/985.6	1170	1055	1092.5	45.5	10.5	1094	4	24	16	M10×1	14
988	1242	105	013.30.1120.03K/P5	1198	1042	1119	90	10	1120	6	36	36	M10×1	18
998	1242	100	013.40.1120.12	1198	1042	1118	90	10	1120	6	36	36	M10×1	M20
1010	1175	90	D2787/1010	1144	1034	1087	72	18	1089	6	36.0	36	M10×1	16.5
--	1200	56	LY-Q036	1170	1044	1088	46	10	1090	4	24	16	M10×1	10.5
1000	1270	100	2782/1000GK	1220	1050	1133	85	15	1135	2	2	24	M10×117/M12	
1020	1250	64	2787/1020G2	1210	1060	1133	54	10	1135	3	30	30	M10×1	17
1090	1400	120	013.40.1250.11	1350	1150	1250	105	15	1250	4	36	36	M10×1	22
1110	1390	110	013.45.1250.03K/P5	1337	1163	1248	100	10	1250	5	40	40	16	M24
--	1382	85	013.35.1257.12	1332	1182	1257	75	10	1257	4	40	40	M10×1	24
1140	1480	126	2787/1140	1400	1200	1298	113	13	1300	10	40	59	M10×1	26
1130	1323	99	2787/1083.7	1274	1162	1199	77	8	1201	2	32	32	M10×1	M20
1180	1500	130	D2787/1180K	1430	1220	1315	110	20	1325	4	24	24	M10×1	M24
1180	1500	130	D2787/1180	1430	1220	1315	110	20	1325	4	24	24	M10×1	M24
--	1640	115	2787/1190	1570	1300	1432	100	15	1435	--	48	48	--	M24
1210	1530	122	2787/1210G2	1480	1260	1368	108	12	1370	4	40	39	ZG1/4	26
1260	1544	102	013.40.1400.11	1486	1314	1402	90	12	1402	4	36	36	M10×1	26
1260	1540	110	013.45.1400.12K	1487	1313	1398	100	10	1400	6	48	48	M10×1	M24
1260	1540	110	013.35.1400.03/P5	1487	1313	1390	100	10	1400	4	40	40	10	26
1278	1595	120	013.40.1435.11	1535	1335	1436.5	105	15	1435	6	36	26	M10×1	26
1284	1630	140	013.60.1465.03	1578	1350	1463	130	10	1465	4	36	22	M10×1	M27
1300	1535	64	E2787/1300	1480	1350	1413	59	15	1415	6	36	36	M10×1	18
1378	1695	165	2787/1278	1636	1434	1534	125	25	1535	8	40	40	M10×1	M27
1400	1715	110	2787/1400K1	1660	1460	1558	95	15	1600	2	24	24	M10×1	23
1400	1715	110	2787/1400GK	1660	1460	1558	95	15	1560	2	24	24	M12	M20

φ3	Gear Parameter					Weight kg ≈	Loading Curve
	da	b	m	Z	x		
M12	216	39	4	56	0	25.6	Fig. 1-1
18	327	45.5	5	67	0	30	Fig. 1-2
M16	440	40	4	112	0	117	Fig. 1-3
18	426.3	60	6	72	0.5	94	Fig. 1-4
M12	470	55	5	96	0	99.6	Fig. 1-5
18	547	46	6	93	0	51.1	Fig. 1-6
13.5	575	37	5	116	0.5	46.9	Fig. 1-7
18	570	60	6	86	0.5	120	Fig. 1-8
17	664	58	8	84	0.5	111	Fig. 1-9
22	632	80	8	80	0.5	256	Fig. 1-10
11	690.54	50	5	140	0	109	Fig. 1-11
M10	690.54	50	5	140	0	108	Fig. 1-12
18	744.32	80	8	94	0.5	248	Fig. 1-13
22	744	58	8	94	0.5	181	Fig. 1-14
22	922	80	10	94	0	251	Fig. 1-15
22	830.1	70	8	105	0.35	294	Fig. 1-16
22	914.4	120	12	78	0	519	Fig. 1-17
18	985.6	45.5	8	125	0	81.7	Fig. 1-18
18	960.25	80	8	121	0.5	298	Fig. 1-19
22	944	80	18	95	0.5	309	Fig. 1-20
16.5	968	60	8	123	0	147	Fig. 1-21
17	990	46	5	200	0	114	Fig. 1-22
17/M12	972.6	70	6	164	0	322	Fig. 1-23
13.5	991	27	5	200	0	176	Fig. 1-24
22	1037	90	10	105	0.35	495	Fig. 1-25
26	1048.8	90	12	88	0.5	404	Fig. 1-26
24	1068	75	12	90	0.5	290	Fig. 1-27
M24	1092	100	10	110	0.5	634	Fig. 1-28
36	1083.7	90	10	110	0	241	Fig. 1-29
27	1110.5	110	6	187	0	673	Fig. 1-30
27	1121.3	110	10	114	0	636	Fig. 1-31
26	1190	100	10	119	0.75	704	Fig. 1-32
26	1164	80	10	118	0	540	Fig. 1-33
26	1188	80	12	100	0.5	447	Fig. 1-34
26	1192.8	90	12	100	0.5	490	Fig. 1-35
M24	1194	100	6	200	0.5	513	Fig. 1-36
26	1221.15	90	12	103	0.35	574	Fig. 1-37
29	1218.6	100	14	88	0.5	782	Fig. 1-38
18	1270	49	5	256	0	188	Fig. 1-39
30	1278	140	18	72	0.5	949	Fig. 1-40
23	1364.5	77	6	230	-0.35	545	Fig. 1-41
M20	1364.5	77	6	230	-0.35	545	Fig. 1-42

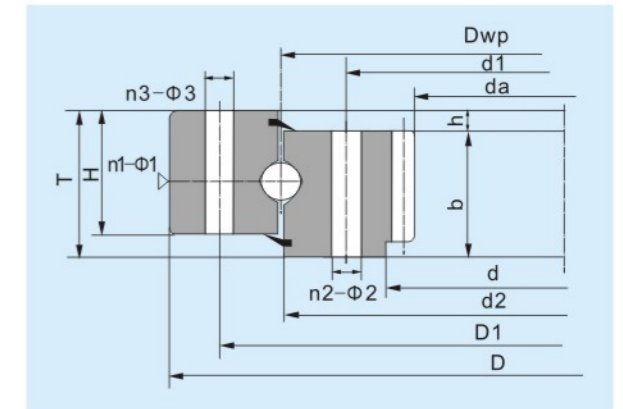



### Four-point Contact Ball Slewing Bearing-with Internal Teeth

d1400~2845mm

Boundary Dimension			Bearing Type	Related Dimension										
d	D	T		D1	d1	d2	H	h	Dwp	n1	n2	n3	φ1	φ2
mm			mm											
1400	1715	110	2787/1400GK1	1660	1460	1558	95	15	1560	2	24	24	M10×1	23
1420	1740	157	014.30.1600.11K	1687	1513	1598	157	47	1600	2	45	45	NPT1/4	M24
1440	1780	100	2787/1440	1730	1494	1618	90	10	1620	4	48	48	M12×1.25	M20
1440	1780	100	2787/1440G	1730	1494	1618	90	10	1620	4	48	48	M12×1.25	M20
1440	1780	104	2768/1440G	1730	1494	1613	87	17	1620	6	48	48	M12×1.25	M20
1525	1875	140	2787/1525G2	1815	1585	1698	123	17	1700	4	42	42	M12×1.25	29
1623	1971	115	013.45.1800.03K1	1905	1695	1802	100	9	1800	9	36	36	M10×1	33
1623	1971	109	013.50.1800.03	1905	1695	1798	99	9	1800	8	48	48	M10×1	M30
1664	1940	110	013.45.1800.03K	1887	1713	1798	100	10	1800	2	30	30	M10×1	26
1644	1940	110	014.45.1800.03K	1887	1713	1800	100	10	1800	9	45	45	M10×1	M24
1650	2000	140	D2787/1650	1910	1700	1795	130	10	1805	4	24	24	M10×1	M24
1833	2178	140	2787/1833	2098	1900	1995	90	10	2000	10	60	47	M10×1	M27
1790	2050	212	2788/1730G2	2006	1847	1924	200	120	1926	6	72	36	M10×1	M20
1790	2050	126	2788/1712K	2006	1847	1925	92	12	1926	18	72	36	M10×1	M22
1790	2050	112	2788/1712	2006	1847	1924	92	12	1926	18	72	36	M10×1	M22
1758	2038	135	2787/1758	1986	1820	1903	90	45	1905.5	20	60	60	M10×1	M24
2057	2299	109	2787/2057	2255	2108	2183	72	9	2182	10	60	44	M10×1	M20
—	2427	145	014.60.2240.03	2375	2100	2239	132	13	2240	6	66	66	RC1/8	26
2121	2500	169	2787/2121	2400	2194	2299	120	9	2297	9	72	72	12 M30×3.5	
2230	2488	160	2789/2230	2445	2275	2337.5	135	5	2340	8	48	48	ZG1/4	M22
2240	2500	140	2789/2240	2454	2280	2320	115	25	2360	8	56	56	M14×1.5	M24
2240	2500	140	2789/2240G2K	2454	2280	2320	115	25	2350	8	56	56	M14×1.5	M24
2240	2500	140	2789/2240G2	2454	2280	2320	115	5	2360	8	56	56	M14×1.5	M24
2325	2678	144	014.60.2500.03K	2610	2391	2497.5	132	12	2500	4	56	56	M10×1	M33
2553	2908	137	2787/2553	2830	2615	2718	95	42	2801.5	15	90	90	M10×1	M27
—	3085	200	013.60.2820.03	3000	2640	2810	178	22	2820	6	60	60	M10×1	36
2625	2978	144	013.60.2800.12K/P5	2910	2691	2790	132	12	2800	8	60	60	M10×1	M30
2687	3074	171	2787/2687	3008	2755	2883	156	30	2800.5	10	86	86	M10×1	M30
2735	2990	160	2789/2735	2945	2770	2810	135	25	2840	8	48	48	ZG1/4	M24
2750	3185	179	013.70.2970.03	3104	2835	2972	129	18	2970	12	84	83	M10×1	M36
2750	3185	179	013.70.2970.03K	3104	2835	2972	152	18	2970	12	84	83	M10×1	M36
2760	3180	144	2787/2760	3100	2860	2978	132	12	2980	10	72	72	M10×1	M36
2798	3180	149	013.63.2990.03	3104	2874	2991	129	18	2990	12	120	119	M10×1	M30
2845	3250	135	2787/2845	3160	2920	3033	9	14	3035	14	100	99	M10×1	M30
—	3200	120	013.35.3070.03/P6	3150	2990	3065	100	20	3070	8	48	48	M10×1	22

φ3	Gear Parameter					Weight	Loading Curve
	da	b	m	Z	x		
						kg ≈	
23	1364.5	77	6	230	-0.35	545	Fig. 1-43
26	1344.711	90	8	170	0	852	Fig. 1-44
22	1400	50	8	177	0	554	Fig. 1-45
22	1400	50	8	177	0	554	Fig. 1-46
22	1400	52	8	177	0	555	Fig. 1-47
29	1452.33	110	16	92	0.35	1019	Fig. 1-48
32	1554.5	100	14	112	0.5	811	Fig. 1-49
33	1554	100	14	112	0.5	800	Fig. 1-50
26	1620	70	6	272	0	659	Fig. 1-51
26	1552	90	16	99	0	756	Fig. 1-52
27	1590.9	110	10	161	0	1036	Fig. 1-53
M27	1764	120	14	127	0.5	949	Fig. 1-54
M20	1730	55	10	175	0	835	Fig. 1-55
22	1712	99	16	108	0.5	859	Fig. 1-56
22	1712	100	16	108	0.5	663	Fig. 1-57
M24	1680	125	16	106	0.5	753	Fig. 1-58
M20	1988	100	14	143	0.5	622	Fig. 1-59
26	1974	125	14	143	0	1343	Fig. 1-60
M30×3.5	2034.24	150	18	114	0.5	1486	Fig. 1-61
M20	2144.25	145	18	121	0	1114	Fig. 1-62
M24	2145.6	125	18	121	0	1161	Fig. 1-63
M24	2145.6	125	18	121	0	1000	Fig. 1-64
M24	2145.6	125	18	121	0	1161	Fig. 1-65
M33	2220	120	20	112	0.5	1400	Fig. 1-66
30	2469.6	120	18	138	0.5	1478	Fig. 1-67
36	2463.4	178	18	138	0.4	3014	Fig. 1-68
M30	2520	120	18	141	0.5	1650	Fig. 1-69
33	2618	130	14	188	0.5	1975	Fig. 1-70
M20	2624.62	144	22	121	0	1457	Fig. 1-71
M39	2672	160	16	168	0.5	2492	Fig. 1-72
39	2672	160	16	168	0.5	2680	Fig. 1-73
39	2664	125	20	134	0.5	2093	Fig. 1-74
33	2720	130	16	171	0.5	1789	Fig. 1-75
33	2757.6	126	18	154	1.8	1974	Fig. 1-76
22	2894.4	100	12	242	0.5	981	Fig. 1-77

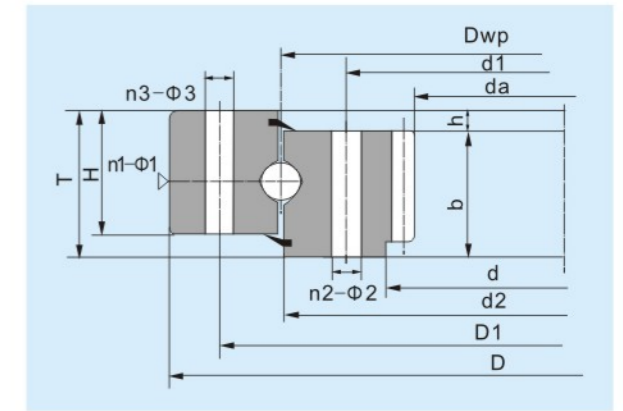



### Four-point Contact Ball Slewing Bearing-with External Teeth

d267~1040mm

Boundary Dimension			Bearing Type	Related Dimension										
d	D	T		D1	d1	d2	H	h	Dwp	n1	n2	n3	φ1	φ2
mm			mm											
267	416	50	D1787/267M	390	295	341	44	6	342	2	16	16	M8×1	17.5
372	563	60	011.25.467.03	529	405	466	50	10	467	2	20	20	M10×1	18
380	523	52	D1787/380	498	408	448	45	7	453	2	16	16	M10×1	½(美制)
398	602	80	012.30.500.12	566	434	498	70	10	500	4	20	20	M10×1	18
430	580	58	011.18.510.03/P5	560	460	505	50	5	510	3	12	12	M10×1	M12
434	--	56	1787/434	585	462	542	45	11	543	4	14	14	M8×1	18
458	662	80	011.30.560.03/P5	626	494	558.5	70	10	560	4	20	20	M10×1	18
468	665	77	D178794	630	500	564.5	64	13	566	6	18	18	M10×1	18
468	665	53	D178794K1	630	500	564.5	43	10	566	6	18	18	M10×1	18
468	665	77	D178794K2	630	500	564.5	64	13	566	6	18	18	M10×1	18
528	732	80	011.30.630.12	696	564	628.5	70	10	630	4	24	24	M10×1	18
597	783	66	011.25.692.12	756	635	691	59	7	692	4	22	24	8	M18
600	--	40	1787/600	770	640	723	35	5	725	2	16	16	M10×1	M12
600	768	72	1787/600G	740	636	689	60	12	690	4	24	20	ZG1/8	19
600	768	72	E1787/600G2K1	740	636	689	60	10	690	4	24	20	M10×1	M16
608	812	80	011.30.710.12	776	644	708.5	70	10	710	4	24	24	M10×1	18
608	812	80	012.30.710.03	776	644	708.5	70	10	710	6	24	24	M10×1	M16
620	820	80	011.25.720.12	780	660	719	68	12	720	3	18	18	M10×1	18
635	--	56.2	011.20.745.03	785	660	743	46.2	10.2	744	4	16	18	M6	18
674	853	70	1787/674G2K	825	709	764	59	10	768	2	24	34	ZG1/8	18
678	922	100	011.40.800.12	878	722	798.5	90	20	800	6	30	30	M10×1	22
690	892	53	1787/690K	875	725	789.5	43	10	791	6	18	18	M10×1	20
710	894	67	1787/710G2K	875	760	798	58	9	803	3	12	8	M10×1	M12
710	894	67	1787/710G2K1	865	744	798	58	9	802	4	20	20	M10×1	13
710	924	67	1787/710G2K2	865	744	798	58	9	802	5	30	30	M10×1	18
760	1020	95	011.30.895.03/P5	980	820	888	80	10	895	2	16	16	M10×1	M16
800	1050	90	1787/800G	1012	838	923	76	16	925	3	30	30	M10×1	20
800	1050	90	1787/800GK	1012	838	923	76	16	925	3	30	30	M10×1	20
800	1110	64	1787/800G2	1012	838	923	54	10	925	3	30	30	M10×1	13.5
800	1110	64	1787/800G2K	1012	838	923	54	10	925	3	30	30	M10×1	13.5
833	1115	82	D1787/835	1015	880	945.5	66	16	947	4	36	36	M10×1	22
834	--	56	011.20.945.03	985	862	942.5	45.5	10.5	944	4	8	10	M8×1	18
876	1110	90	E1787/876G2	1074	926	997	80	10	998.5	--	24	24	--	17.5
878	1122	100	011.40.1000.12	1078	922	998.5	90	10	1000	6	36	36	M10×1	22
878	1122	100	011.40.1000.12K	1078	922	998.5	90	10	1000	4	20	20	M10×1	M20
878	1122	100	011.40.1000.12K1	1078	922	998.5	90	10	1000	4	20	20	M10×1	M20
957	1150	80	011.25.1055.03	1116	995	1057	54	9	1055	4	30	30	M10×1	22
982	1240	114	011.35.1116.03	1198	1035	1118	94	24	1116	4	48	48	M10×1	24
984	--	56	011.20.1097.03	1135	1012	1095.5	45.5	10.5	1097.5	4	40	44	M6	18
998	1242	100	011.40.1120.12K	1198	1042	1118.5	90	10	1120	6	18	18	M10×1	M20
998	1242	100	011.40.1120.12K1	1198	1042	1118	90	10	1120	6	36	36	M10×1	22
998	1242	100	011.40.1120.12K2	1198	1042	1118.5	90	10	1120	6	18	18	ZG1/4	22
1013	--	79	011.25.1120.12	1183	1057	1121	54	9	1120	5	30	30	M10×1	22
1040	--	80	1788/1040G2	1220	1080	1153	70	10	1155	--	30	30	--	17.5
1040	--	80	1788/1040G2K1	1220	1080	1153	70	10	1155	6	30	30	M10×1	M16
1040	--	70	1788/1040G2K2	1220	1080	1153	60	10	1155	6	30	30	M10×1	17.5
1040	--	80	E1788/1040G2K3	1220	1080	1153	70	10	1155	--	30	30	--	16

φ3	Gear Parameter					Weight	Loading Curve
	da	b	m	Z	x		
						kg ≈	
17.5	447	39	3	147	0	30.8	Fig. 1-78
18	573.48	30	2	285	-0.13	49.5	Fig. 1-79
½(美制)	550	38	5	108	0	34.8	Fig. 1-80
18	630	60	6	102	0.5	87.6	Fig. 1-81
14	605	45	2.5	240	0	52.7	Fig. 1-82
M12	640.3	45	6	105	0	40.9	Fig. 1-83
M16	684	60	5	169	0	95.8	Fig. 1-84
M16	696	60	6	114	0	93.1	Fig. 1-85
M16	696	40	6	114	0	55.5	Fig. 1-86
M16	760	60	5	150	0	131	Fig. 1-85
18	772.8	60	6	126	0.5	120	Fig. 1-87
18.5	816	51	6	134	0	71.4	Fig. 1-88
M12	840	35	6	138	0	51.2	Fig. 1-89
M18×2.5	798	50	6	131	0	94.1	Fig. 1-90
M16	798	50	6	131	0	93	Fig. 1-91
18	850.8	60	6	139	0.5	124	Fig. 1-92
17.5	856	60	8	104	0.5	120	Fig. 1-93
M16	860.3	60	6	139	1.4	130	Fig. 1-94
M12	837.6	46	6	138	-0.2	55.5	Fig. 1-95
18	889	50	7	125	0	88.6	Fig. 1-96
22	960	80	8	118	0.5	224	Fig. 1-97
M18	924	40	6	152	0	88.8	Fig. 1-98
M10	924	55	6	152	0	107	Fig. 1-99
13	924	55	6	152	0	105	Fig. 1-100
18	924	55	6	152	0	99	Fig. 1-101
18	1072	70	4	266	0	250	Fig. 1-102
20	1092	60	6	180	0	217	Fig. 1-103
20	1092	60	6	180	0	217	Fig. 1-103
M12	1110	27	5	220	0	161	Fig. 1-104
M12	1110	27	5	220	0	161	Fig. 1-104
22	1115	72	6	184	0	172	Fig. 1-105
12	1048	45.5	8	128	0	72.5	Fig. 1-106
M22	1170	70	10	116	-0.5	258	Fig. 1-107
22	1190	80	10	116	0.5	305	Fig. 1-108
M20	1180	80	10	116	0	305	Fig. 1-109
M20	1180	80	10	116	0	314	Fig. 1-109
M20	1198	70.5	10	118	0	177	Fig. 1-110
24	1289.5	78	10	125	0.5	319	Fig. 1-111
M12	1198.4	45.5	8	148	0	83.4	Fig. 1-112
22	1300	80	10	127	0.5	352	Fig. 1-113
22	1298	80	10	127	0.5	334	Fig. 1-114
M20	1300	80	10	127	0.5	352	Fig. 1-113
22	1278	70	10	125	0.5	196	Fig. 1-115
M16	1314.1	70	10	125	0	251	Fig. 1-116
17.5	1320	70	8	163	0	263	Fig. 1-116
M16	1310	60	5	260	0	224	Fig. 1-116
M16	1380	70	10	136	0	316	Fig. 1-116

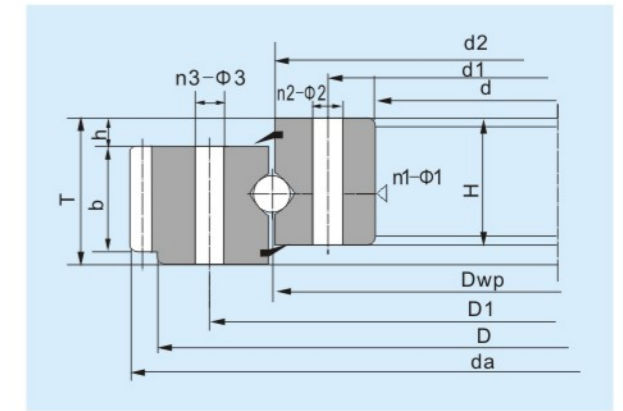



### Four-point Contact Ball Slewing Bearing-with External Teeth

d1060~2500mm

Boundary Dimension			Bearing Type	Related Dimension										
d	D	T		D1	d1	d2	H	h	Dwp	n1	n2	n3	φ1	φ2
mm			mm											
1060	1335	109	1787/1060G	1295	1105	1198	100	9	1200	4	24	24	M8×1	22
1060	1335	109	1787/1060G2	1295	1105	1198	100	9	1200	4	24	24	M8×1	22
1075	1424	120	D1787/1075	1310	1130	1218	90	15	1220	4	36	36	M8×1	26
1075	1365	130	1787/1075K	1310	1130	1218	105	15	1220	--	36	36	--	24
1075	--	130	1787/1075K1	1310	1130	1218	105	10	1220	3	36	36	M10×1	24
1075	1365	120	1787/1075G2	1310	1130	1218	105	15	1220	4	36	36	M10×1	24
1075	1365	120	1787/1075G2K	1310	1130	1218	105	15	1220	4	36	36	M8×1	26
1110	1390	110	011.45.1250.12	1337	1163	1248	100	10	1250	5	40	40	M10×1	26
1155	--	80	1787/1155	1316	1195	1253	54	9	1255	6	42	42	M10×1	22
1208	1551	130	011.50.1390.03	1500	1280	1392	113	13	1390	4	48	48	M10×1	30
1260	1540	110	011.45.1400.12	1487	1313	1398	100	10	1400	5	40	40	M10×1	22
1260	1540	110	011.45.1400.12K	1487	1313	1398	100	10	1400	5	40	40	M10×1	22
1260	1540	110	011.45.1400.12K1	1487	1313	1402	100	10	1398	5	40	40	M14×1.5	26
1260	1596	102	D1787/1260	1535	1330	1428	86	19.5	1430	5	30	30	M10×1	26
1278	1595	120	011.35.1435.12	1535	1335	1436	105	15	1435	2	36	36	M16×1.5	26
1305	--	90	1787/1305	1510	1345	1448	71	18	1450	6	--	--	M8×1	--
1330	1475	82.4	1787/1330G2	1510	1362	1451	70	12.4	1442	6	24	24	M10×1	18.5
1388	--	89	011.30.1500.04	1568	1432	1501	63	9	1500	6	48	48	M10×1	22
1410	--	85	E1788/1410G2K1	1590	1454	1524.5	70	15	1526.6	--	30	30	--	18
1410	1700	85	1788/1410G2K	1590	1454	1524.6	70	15	1526.6	3	36	36	M10×1	17.5
1410	--	85	1788/1410G2	1590	1454	1524.6	70	15	1526.6	--	36	36	--	17.5
1410	--	85	1788/1410	1590	1454	1524.6	70	15	1526.6	--	36	36	--	17.5
1458	1932	152	1787/1460	1745	1520	1630	135	35	1632	6	40	40	ZG1/4	26
1458	1800	152	1787/1460K	1745	1520	1681	135	35	1632	6	40	40	ZG1/4	26
1460	1747	110	011.45.1600.12K	1687	1513	1598	100	10	1600	6	40	40	ZG1/4	26
1460	1730	110	012.45.1600.12K	1687	1513	1598	100	10	1600	5	20	20	M10×1	M24
1460	1730	110	012.45.1600.12K1	1687	1513	1598	100	10	1600	5	20	20	M10×1	M24
1500	1860	160	011.50.1682.03/P5	1790	1575	1680	140	5	1682	4	48	48	M18×1.5	33
1634	1964	124	012.50.1800.03	1904	1696	1802	112	12	1800	4	44	44	M10×1	30
1660	1940	110	012.45.1800.03	1887	1713	1798	100	10	1800	5	45	45	M10×1	26
1660	1940	140	011.45.1800.03K/P5	1887	1713	1798	130	10	1800	3	45	45	M10×1	26
1660	--	110	011.45.1800.03	1887	1713	1798	100	10	1800	5	45	45	M10×1	26
1628	1927	130	1787/1628G2K1	1875	1680	1774	115	15	1776	4	36	36	M10×1	26
1640	2050	160	1787/1640G	1990	1710	1844	132	20	1850	2	30	30	M14×1.5	28
1700	1945	120	1787/1700	1900	1750	1825	110	10	1835	4	24	24	M10×1	21
1700	2052	100	1789/1700GM	1980	1780	1878	90	10	1880	4	24	24	M14×1.5	M18
1825	2178	144	011.40.2000.12	2110	1891	1998	132	12	2000	8	48	48	M10×1	33
1825	2178	144	011.60.2000.12	2110	1891	1998	132	12	2000	8	48	48	M10×1	33
1825	2160	144	011.60.2000.12K	2110	1891	1998	132	12	2000	8	45	45	M10×1	33
1825	2178	144	012.60.2000.12	2110	1891	1998	132	12	2000	8	48	48	M10×1	33
1877	2125	111	1788/1877	2068	1927	2001	69	9	2000	5	40	40	M10×1	22
1948	--	130	1787/1948	2235	2016	2124	108	10	2126	8	48	48	M10×1	33
2050	2418	160	011.60.2240.03K/P5	2350	2131	2238	140	0	2240	4	48	48	M18×1.5	33
2063	--	144	012.60.2240.03K	2350	2131	2239	135	9	2240	11	54	54	M10×1	33
2065	2418	144	012.60.2240.12	2350	2131	2238	132	12	2240	8	48	48	M10×1	33
2325	2678	144	011.40.2500.12	2610	2391	2498	132	12	2500	8	56	56	M10×1	33
2325	2678	144	011.60.2500.12	2610	2391	2498	132	12	2500	8	56	56	M10×1	33
2325	2678	144	011.50.2500.12	2610	2391	2497.5	132	12	2500	6	54	54	ZG1/4	33
2325	2678	144	012.50.2500.03	2610	2391	2502	132	12	2500	8	56	56	M10×1	M30
2325	2678	144	012.60.2500.12	2610	2391	2498	132	12	2500	8	56	56	M10×1	33
2500	--	205	012.70.2700.03	2835	2565	2704	180	25	2700	8	68	67	M10×1	33

φ3	Gear Parameter					Weight	Loading Curve
	da	b	m	Z	x		
						kg ≈	
M20	1388	80	10	138	-0.6	407	Fig. 1-117
M20	1388	80	10	138	-0.6	389	Fig. 1-117
26	1424	90	8	176	0	463	Fig. 1-118
24	1420	120	10	140	0	550	Fig. 1-119
M24	1420	120	10	140	0	549	Fig. 1-119
24	1424.9	90	10	138	1.4	463	Fig. 1-119
M24	1424	90	8	176	0	463	Fig. 1-118
26	1449.6	90	12	118	0.5	405	Fig. 1-120
18	1398	71	10	138	0	214	Fig. 1-121
30	1604	85	10	157	0.75	652	Fig. 1-122
M20	1605.6	90	12	131	0.5	468	Fig. 1-123
M20	1605.6	90	12	131	0.5	481	Fig. 1-124
26	1605.6	90	12	131	0.5	482	Fig. 1-125
M24	1650	60	6	273	0	397	Fig. 1-126
26	1655.5	90	12	134	1.15	636	Fig. 1-127
--	1600	71	10	158	0	258	Fig. 1-268
18.5	1584	70	9	174	0	280	Fig. 1-128
22	1677.6	80	12	137	0.5	327	Fig. 1-129
M16	1676.4	70	10	160	0	314	Fig. 1-130
M16	1700	70	10	168	0	335	Fig. 1-131
M16	1676.4	70	10	160	0	312	Fig. 1-131
M16	1676.4	70	10	160	0	312	Fig. 1-131
26	1932	60	12	159	0	865	Fig. 1-132
26	1932	60	12	159	0	908	Fig. 1-133
26	1817.2	90	14	127	0.5	651	Fig. 1-134
M24	1808	90	16	111	0	559	Fig. 1-135
M24	1808	90	16	111	0	569	Fig. 1-135
33	1992	140	12	164	0	1276	Fig. 1-136
30	2048	100	16	127	-0.5	824	Fig. 1-137
26	2012.8	90	16	123	0.5	644	Fig. 1-138
M24	2014	120	14	141	0.5	805	Fig. 1-138
26	2016	100	14	141	0.5	684	Fig. 1-138
26	2002	105	14	141	0	815	Fig. 1-139
28	2108	105	10	210	-0.6	1264	Fig. 1-140
M18	1970	35	5	392	0	516	Fig. 1-141
20	2080	50	5	414	0	678	Fig. 1-142
33	2268.8	120	16	139	0.5	1155	Fig. 1-143
33	2268.8	120	16	139	0.5	1300	Fig. 1-144
33	2240	120	16	139	-0.5	970	Fig. 1-145
33	2268	120	18	123	0.5	1217	Fig. 1-146
M20	2195.2	101	14	154	0.5	600	Fig. 1-147
M30	2390	120	18	130	0.5	1115	Fig. 1-148
33	2558.4	140	12	212	-0.4	1787	Fig. 1-149
M30	2498.4	135	18	136	0.5	1320	Fig. 1-150
33	2498.4	120	18	136	0.5	1388	Fig. 1-151
33	2769.7	120	18	151	0.5	1533	Fig. 1-152
33	2772	120	18	151	0.5	1460	Fig. 1-153
33	2768.4	120	18	151	0.5	1507	Fig. 1-154
33	2800	120	20	138	0	1625	Fig. 1-155
33	2780	1					



### Four-point Contact Ball Slewing Bearing-with External Teeth

d2617~4810mm

Boundary Dimension			Bearing Type	Related Dimension										
d	D	T		D1	d1	d2	H	h	Dwp	n1	n2	n3	φ1	φ2
mm			mm											
2617	2919	137	1788/2617	2850	2677	2765	92	12	2764	7	84	84	M10×1	30
2617	2919	137	1788/2617K	2850	2677	2765	92	12	2764	7	84	84	M10×1	30
2625	2978	144	012.60.2800.03	2910	2691	2798	132	12	2800	8	56	56	M10×1	M30
2625	2978	144	012.60.2800.12	2910	2691	2798	132	12	2800	8	56	56	M10×1	33
2625	2978	144	012.60.2800.11K	2910	2691	2798	132	12	2800	8	56	56	M10×1	33
2635	3332	270	1787/2635G2	3240	2755	2988	235	35	2998	12	36	36	M10×1	39
2650	2885	100	1787/2650G2	2850	2700	2712	80	10	2775	6	48	48	ZG1/4	M20
2800	3260	220	012.75.3030.03	3190	2870	3021	198	22	3030	6	60	60	M10×1	39
2833	3164	145	1787/2833	3087	2899	2995	107	20	2993	12	60	60	M10×1	33
2922	3376	174	011.75.3150.03	3286	3014	3147.5	162	12	3150	8	56	56	M10×1	45
2922	3376	174	012.75.3150.03	3286	3014	3147.5	162	12	3150	6	56	56	6	45
3250	3816	175	1787/3250	3600	3340	3470	160	35	3470	12	72	72	M10×1	M36
3322	3776	134	012.60.3550.12/P6	3686	3414	3548	122	12	3550	8	40	40	M10×1	33
4810	5277	210	1787/4810	5187	4900	5036	165	15	5044	8	60	60	ZG1/4	M42

φ3	Gear Parameter					Weight	Loading Curve
	da	b	m	Z	x		
						kg ≈	
M27	3002.4	120	18	164	0.5	1204	Fig. 1-158
M27	3002.4	120	18	164	0.5	1204	Fig. 1-158
M30	3080	120	20	151	0.5	1670	Fig. 1-159
33	3076	120	20	151	0.5	1660	Fig. 1-159
33	3080	120	20	151	0.5	1670	Fig. 1-159
39	3440	200	20	170	0	6220	Fig. 1-160
M20	2949.6	80	12	244	0	751	Fig. 1-161
39	3360	160	20	166	0	3510	Fig. 1-162
33	3256	124	20	160	0.5	1627	Fig. 1-163
45	3480	150	20	171	0.5	3182	Fig. 1-164
45	3471.6	150	20	155	0.5	3053	Fig. 1-164
39	3816	160	24	157	0	3273	Fig. 1-166
33	3889.6	110	22	174	0.5	2814	Fig. 1-167
45	5400	180	25	214	0	5489	Fig. 1-168

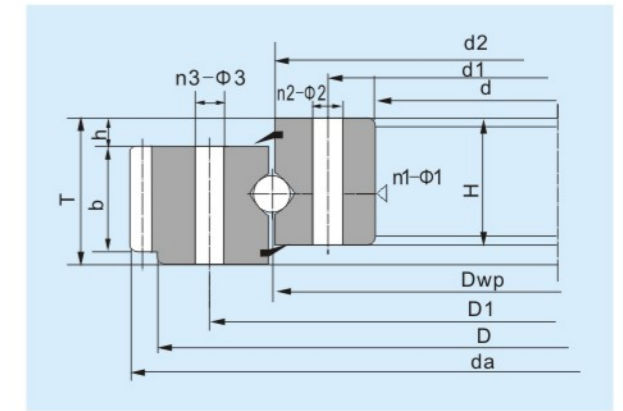



### Four-point Contact Ball Slewing Bearing-without Teeth

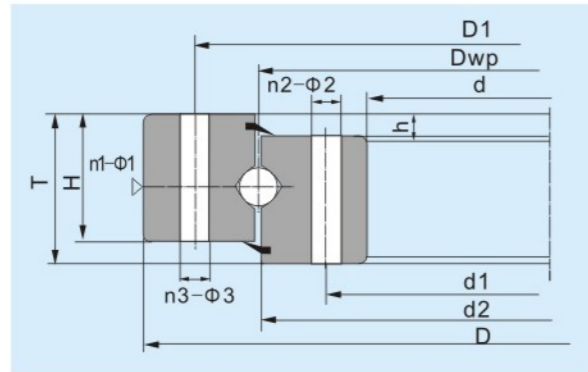

d156~608mm

Boundary Dimension			Bearing Type	Related Dimension										Weight	Loading Curve		
d	D	T		D1	d1	d2	H	h	Dwp	n1	n2	n3	φ1			φ2	φ3
mm			mm										kg ≈				
156	256	60	010.20.200.12	239	172	199	50	10	200	2	12	12	M8×1	M6	7	11.5	Fig. 1-261
216	385	54	010.20.310.03	358	259	309	44	10	310	1	12	12	M10×1	M12	M12	25.6	Fig. 1-169
240	440	55	LY-Q020	400	280	340	50	5	341	3	18	18	M10×1	20	M20	34.7	Fig. 1-170
260	480	60	116752	444	296	360	60	0	370	--	16	16	--	14	14	55	Fig. 1-171
260	480	60	116752K	--	--	360	60	0	370	--	--	--	--	--	--	58.6	Fig. 1-262
275	485	55	LY-Q007	453	307	381	50	5	380	4	16	16	M10×1	M16	18	43.7	Fig. 1-172
275	485	55	LY-Q007K	453	307	381	50	5	380	4	16	16	M10×1	18	18	43.7	Fig. 1-173
285	473	68	787/285G2	438	320	379	59	9	380	4	24	24	M10×1	18	18	44	Fig. 1-174
304	454	56	787/304RG2	490	332	412.5	44.5	11.5	414	--	12	8	--	18	18	23.7	Fig. 1-175
360	480	35	78972	460	380	419	35	0	421	--	15	12	--	13	M12	19.3	Fig. 1-176
372	573.48	60	010.25.467.03	529	405	466	50	10	467	2	20	20	M10×1	18	18	49.5	Fig. 1-177
398	602	80	010.30.500.12	566	434	498.5	70	10	500	4	20	20	M10×1	18	18	75.8	Fig. 1-178
434	648	56	787/434G2	620	462	543	47	9	545	4	14	10	M8×1	18	18	33.6	Fig. 1-179
450	600	45	D78790	576	482	527.5	45	0	529	--	16	16	--	M12	M12	39.5	Fig. 1-180
450	654.8	92	78790G2	626	478	545.8	92	2	547.5	2	8	8	M10×1	M8	M16	114	Fig. 1-181
458	662	80	010.30.560.12	626	494	558.5	70	10	560	4	20	20	M10×1	18	18	94	Fig. 1-182
460	590	45	176792	570	488	518	45	0	530	--	12	8	--	10	M10	35.9	Fig. 1-183
460	590	45	176792K	570	488	518	45	0	530	--	12	12	--	10	10	36	Fig. 1-183
460	590	45	176792K2M	570	488	526	45	0	530	--	8	12	--	10	10	30.8	Fig. 1-260
460	590	40	D176792K3M	570	488	527	40	0	530	--	12	12	--	9	M8	32.8	Fig. 1-184
460	590	40	D78892K	570	488	527	40	--	530	--	12	12	--	9	M8	32.7	Fig. 1-185
470	645	55	78794G2	610	520	563.5	45	10	565	4	16	16	M10×1	13	M12	52.6	Fig. 1-186
490	630	70	010.25.585.03/P5	650	520	583.5	60	10	585	3	30	30	M10×1	M10	11	75	Fig. 1-187
512	741	68	010.28.646.03	705	587	644	59	7	646	2	22	22	M10×1	M16	18	126	Fig. 1-188
528	732	80	010.30.630.12	696	564	628.5	70	10	630	4	24	24	ZG1/4	18	18	105	Fig. 1-189
530	780	60	1167/530	740	560	645	60	--	655	--	20	20	--	13	17	103	Fig. 1-190
560	800	82	787/560G2	754	606	678.5	73	9	680	4	24	24	M10×1	M20	22	129	Fig. 1-191
560	720	36	1167/560	690	590	638.5	36	3	640	--	12	12	--	12	14	38.1	Fig. 1-192
560	720	36	1167/560K	690	590	634	36	3	640	--	32	12	--	16	M12	39.2	Fig. 1-193
560	720	36	1167/560M	690	590	638.5	30	3	640	--	12	12	--	12	14	38.1	Fig. 1-194
560	720	36	1167/560MK1	690	590	634	36	3	640	--	16	12	--	16	M12	37.6	Fig. 1-195
560	780	60	1168/560	--	--	645	60	3	655	--	--	--	--	--	--	103	Fig. 1-263
572	716	56	010.20.644.11	690	598	643	45.5	10.5	644	4	36	36	ZG1/4	13.5	13.5	45.7	Fig. 1-196
608	812	80	010.30.710.12K	776	644	708.5	70	10	710	4	24	24	ZG1/4	18	18	109	Fig. 1-197
608	812	80	010.30.710.12/P5	776	644	708.5	70	10	710	4	12	12	M10×1	13.5	M12	114	Fig. 1-198

d630~1126mm

Boundary Dimension			Bearing Type	Related Dimension										Weight	Loading Curve		
d	D	T		D1	d1	d2	H	h	Dwp	n1	n2	n3	φ1			φ2	φ3
mm			mm										kg ≈				
630	850	56	010.20.745.03K	820	664	743	46	10	744	2	32	24	M8×1	18	18	43.9	Fig. 1-199
630	780	69	11768/630	--	--	718	69	0	720	--	--	--	--	--	--	79.4	Fig. 1-264
635	950	56.2	010.20.745.03	900	660	743	46	10.2	744	4	16	12	M6	18	M10	70.2	Fig. 1-200
670	800	70	787/670G2	798	692	738	600	10	745	4	12	12	M10×1	M8	M8	71.1	Fig. 1-201
675	875	80	787/675	822	706	761	70	10	761	4	24	24	G1/4	20	26	120	Fig. 1-202
680	865	55	D787/680	830	730	780.8	40	15	788	1	6	30	ZG1/8	12	M8	33.6	Fig. 1-203
700	900	36	1167/700	860	740	796	36	3	800	--	12	12	--	17	M16	60	Fig. 1-204
700	900	36	1167/700K	860	740	796	36	3	800	--	12	12	--	18	18	61.2	Fig. 1-205
700	900	52	787/700	860	740	798.5	40	12	800	4	12	12	M10×1	17	M16	76.1	Fig. 1-206
734	948	56	787/734G2	920	760	842.5	44	12	844	4	12	12	M8×1	14	14	48.1	Fig. 1-207
760	950	80	E787/760G2	915	795	853.5	71	9	855	4	24	24	M10×1	M16	18	138	Fig. 1-208
762	1066.8	89	787/762G2	997	832	913	76.5	12.5	914.5	4	32	28	M10×1	18	18	241	Fig. 1-209
774	914	56	QJ6/774YA	890	798	837	46	10	844.0	2	20	40	M10×1	M12	M12	54.9	Fig. 1-210
775	1000	64	3-640	948	802	878	49	15	880	2	12/12	24	M8×1	13/M12	M12	112	Fig. 1-211
775	1000	64	3-640K	948	802	878	49	15	880	2	12/12	24	M8	13/M12	M12	112	Fig. 1-211
778	1022	100	010.30.900.12	978	822	898	90	10	900	6	30	30	M10×1	22	22	203	Fig. 1-212
800	1050	90	787/800G	1012	838	923	76	14	925	3	30	30	M10×1	20	20	192	Fig. 1-213
807	1098	90	010.30.955.11	1060	845	956.5	71	19	955	6	48	47	M10×1	22	22	126	Fig. 1-214
810	1010	72	LY-Q001	--	--	898	72	0	910	--	--	--	--	--	--	140	Fig. 1-265
850	1120	85	71769/850Y	1074	924	995	85	0	1003	--	12	12	--	22	M20	248	Fig. 1-215
850	1120	85	71769/850G2K	1074	924	999	85	0	1001	--	12	12	--	22	17	257	Fig. 1-216
870	1130	100	D787/870G2	1074	926	992	90	10	1000	3	24	24	M10×1	M16	M16	254	Fig. 1-217
878	1122	82	010.30.1000.12K	1078	922	998	72	10	1000	1	36	36	M16×1.5	22	22	198	Fig. 1-218
920	1168	80	010.30.1060.03	1130	970	1052	70	10	1060	4	24	24	M14×1.5	18	18	207	Fig. 1-219
920	1168	80	010.30.1060.12	1130	970	1053	70	10	1060	4	24	24	M14×1.5	18	18	207	Fig. 1-219
932	1200	120	787/932G2	1148	984	1092	100	20	1066	4	40	40	G1/4	M24	26	328	Fig. 1-220
932	1200	120	787/932G2K	1148	984	1064	100	20	1066	4	40	40	G1/4	26	26	340	Fig. 1-220
960	1165	90	787/960G2	1135	1040	1073	76	12	1075	6	36	36	M10×1	M16	28	203	Fig. 1-221
998	1242	100	010.40.1120.12	1198	1042	1118	90	10	1120	6	36	36	M10×1	22	M20	274	Fig. 1-222
1000	1250	100	787/1000G2	1206	1044	1123	90	10	1125	3	12	12	M10×1	M16	18	283	Fig. 1-223
1000	1250	100	787/1000G2K	1206	1044	1123	90	10	1125	3	36	36	M10×1	18	18	275	Fig. 1-224
1110	1390	110	010.30.1250.12	1337	1163	1248	100	10	1250	5	40	40	M10×1	26	26	391	Fig. 1-225
1126	1374	90	010.35.1250.12	1324	1176	1248	80	10	1250	2	32	32	M10×1	M22	M22	285	Fig. 1-226



### Four-point Contact Ball Slewing Bearing-without Teeth

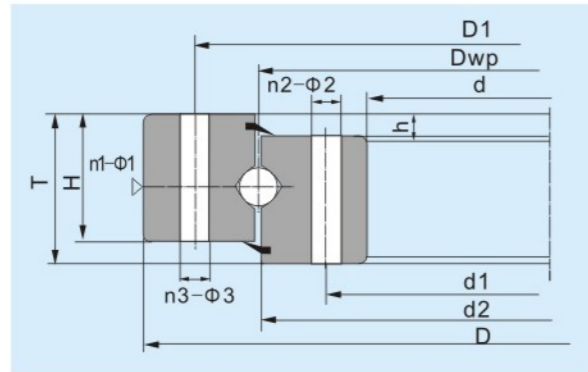

d1150~2625mm

Boundary Dimension			Bearing Type	Related Dimension											Weight	Loading Curve	
d	D	T		D1	d1	d2	H	h	Dwp	n1	n2	n3	φ1	φ2			φ3
mm			mm											kg ≈			
1150	1410	110	010.45.1284.12	1366	1200	1282	100	10	1284	4	36	36	M14×15	18	18	407	Fig. 1-227
1180	1480	84	010.35.1352.12	1435	1230	1345	74	10	1352	4	24	24	M14×15	22	22	352	Fig. 1-228
1184	1524	125	787/1184	1458	1250	1377	113	12	1354	10	39	400	M10×1	33	33	537	Fig. 1-229
1210	1600	180	787/1210	1530	1270	1394	150	301400.5	7	44	45	ZG1/8	M24	26	971	Fig. 1-230	
1260	1540	91	787/1260	1487	1313	1401	81	10	1400	6	40	40	M10×1	26	26	337	Fig. 1-231
1260	1509	90	789/1260G2	1465	1315	1386	70	14	1387.5	2	36	36	ZG1/8	M20	22	274	Fig. 1-232
1260	1509	90	789/1260G2K	1465	1315	1386	70	14	1387.5	2	36	36	ZG1/8	M20	22	281	Fig. 1-232
1260	1540	110	010.45.1400.12K	1487	1313	1398	100	10	1400	5	40	40	M10×1	26	26	462	Fig. 1-233
1278	1702	146	787/1278	1650	1330	1488	136	10	1490	6	24	24	M10×1	26	26	987	Fig. 1-234
1300	1600	84	787/1300G2	1555	1350	1470	74	10	1472	4	24	24	ZM10	22	22	392	Fig. 1-235
1400	1820	136	71169/1400Y	1750	1470	1608	136	0	1610	4	24	24	M10×1	35	35	1114	Fig. 1-236
1400	1820	136	71169/1400Y1	1750	1470	1608	136	0	1610	4	24	24	M10×1	35	35	1120	Fig. 1-237
1430	1832	190	787/1430	1770	1490	1623	180	301620.5	7	44	45	ZG1/8	M30	33	1211	Fig. 1-238	
1440	1780	100	787/1440G2	1730	1494	1618	85	15	1620	4	48	48	M12×1.25	M20	22	533	Fig. 1-239
1460	1740	110	010.45.1600.12K/P5	1687	1513	1598	100	10	1600	5	45	45	M10×1	M24	26	474	Fig. 1-240
1525	1815	110	787/1525G2	1766	1584	1678	100	10	1680	6	24	24	M10×1	22	22	601	Fig. 1-241
1628	1927	130	787/1628G2	1875	1680	1804	115	15	1776	6	36	36	G1/4	M24	26	732	Fig. 1-242
1628	1927	130	787/1628G2K	1875	1680	1807	115	15	1776	6	36	36	G1/4	M24	26	750	Fig. 1-242
1628	1927	130	787/1628G2K1	1875	1680	1774	115	15	1776	4	36	36	M10×1	26	26	717	Fig. 1-242
1660	1940	110	010.45.1800.12	1887	1802	1794	100	10	1800	5	45	45	M10×1	26	26	593	Fig. 1-243
1660	1940	110	010.45.1800.12K	1887	1713	1802	100	10	1800	4	40	40	M14×1.5	26	26	598	Fig. 1-244
1700	2000	150	787/1700KM	1950	1750	1842	130	20	1850	4	24	24	M10×1	21	21	826	Fig. 1-245
1785	2209	120	787/1785	2135	1855	1992	105	15	1995	4	36	36	ZG1/8	33	33	1070	Fig. 1-246
1785	2180	144	787/1785G2	2110	1850	1977.5	132	12	1980	8	36	36	M14×1.5	33	33	1240	Fig. 1-247
1825	2178	144	010.60.2000.12	2110	1891	1998	132	12	2000	8	48	48	M10×1	33	33	985	Fig. 1-248
1920	2294	120	787/1920	2240	2028	2131	100	20	2134	4	36	36	ZG1/8	22	22	919	Fig. 1-249
2000	2395	144	787/2000G2	2325	2065	2192.5	132	12	2195	8	36	36	M14×1.5	33	33	1380	Fig. 1-250
2065	2418	144	010.60.2240.12	2350	2131	2242	132	12	2240	8	48	48	M10×1	33	33	1116	Fig. 1-251
2110	2450	120	LY-009	--	--	--	120	0	2280	--	--	--	--	--	--	992	Fig. 1-266
2279	2721	146	787/2279	2655	2345	2498	136	10	2500	9	72	72	M10×1	33	33	1751	Fig. 1-252
2535	2845	150	010.60.2690.03	2798	2582	2686	130	20	2692	2	32	32	M10×1	30	M27	1199	Fig. 1-253
2625	2978	144	010.60.2800.12	2910	2691	2798	132	12	2800	8	56	56	M10×1	33	33	1383	Fig. 1-254
2625	2978	112	787/2625	2910	2691	2797.5	100	12	2800	8	56	56	M10×1	33	33	1152	Fig. 1-256
2625	2978	114	787/2625K	2910	2691	2797.5	132	12	2800	8	56	56	M10×1	33	33	1393	Fig. 1-255

d2665~4810mm

Boundary Dimension			Bearing Type	Related Dimension											Weight	Loading Curve	
d	D	T		D1	d1	d2	H	h	Dwp	n1	n2	n3	φ1	φ2			φ3
mm			mm											kg ≈			
2665	2966	113	010.40.2800.03K	2914	2717	2801	104	28	2800	12	48	48	M10×1	26	26	986	Fig. 1-257
2340	2680	120	LY-Q005	--	--	2490	120	0	2510	--	--	--	--	--	--	1088	Fig. 1-267
4060	4680	210	010.70.4370.03	4580	4160	4366	170	40	4370	9	90	90	M10×1	39	39	5223	Fig. 1-258
4810	5277	210	787/4810	5187	4900	5036	195	45	5044	8	60	60	ZG1/4	45	45	4631	Fig. 1-259



Loading curve

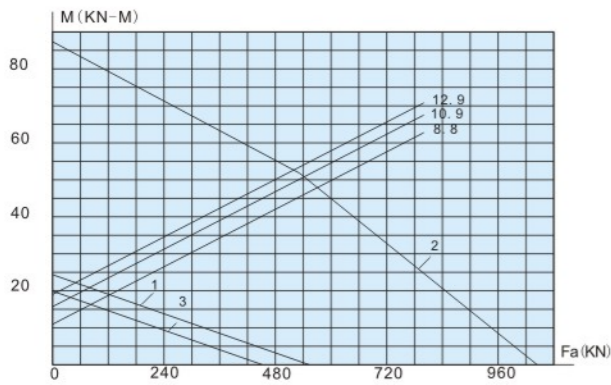

Fig. 1-1 013. 20. 310. 12

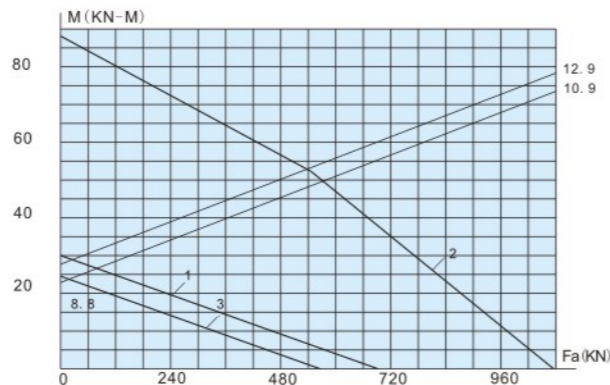

Fig. 1-2 2787/327

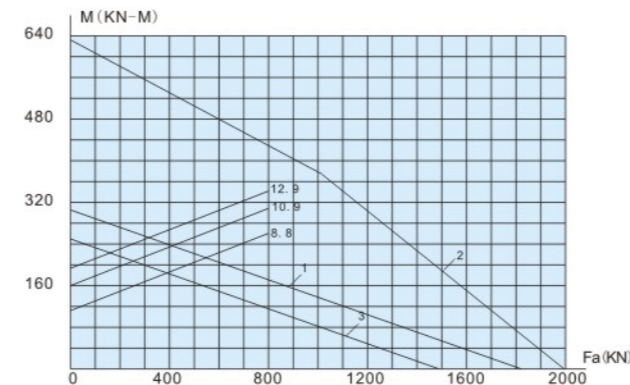

Fig. 1-9 013. 25. 800. 11

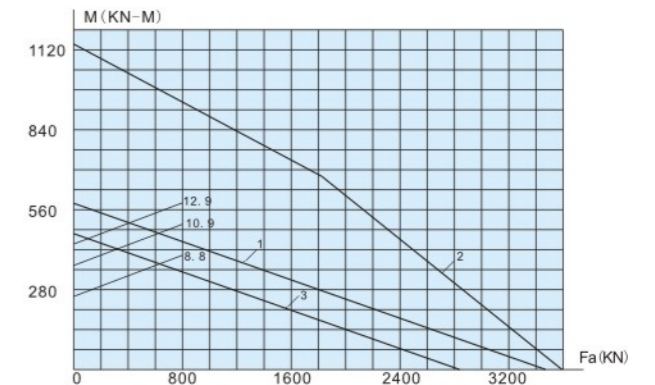

Fig. 1-10 013. 40. 800. 12

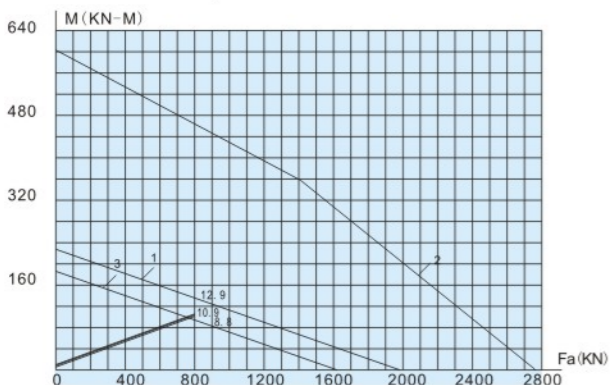

Fig. 1-3 278790G2

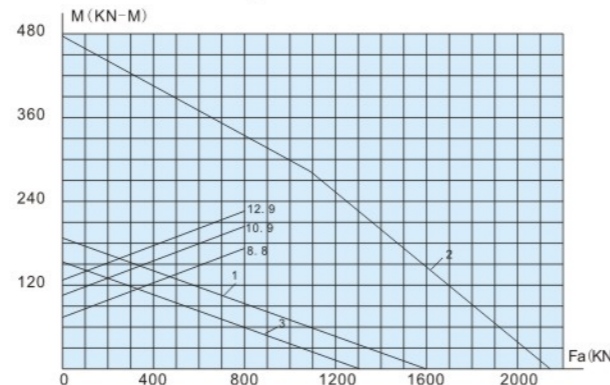

Fig. 1-4 014. 30. 560. 12

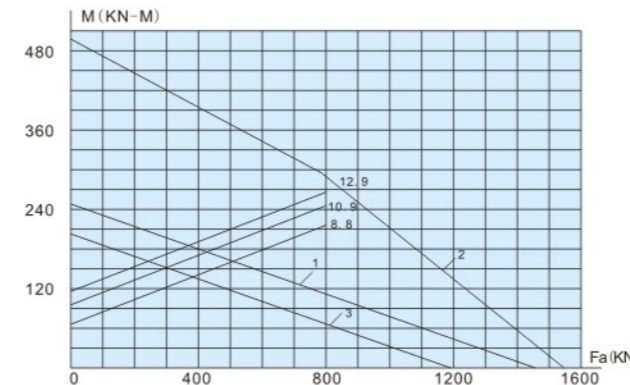

Fig. 1-11 LY-Q035

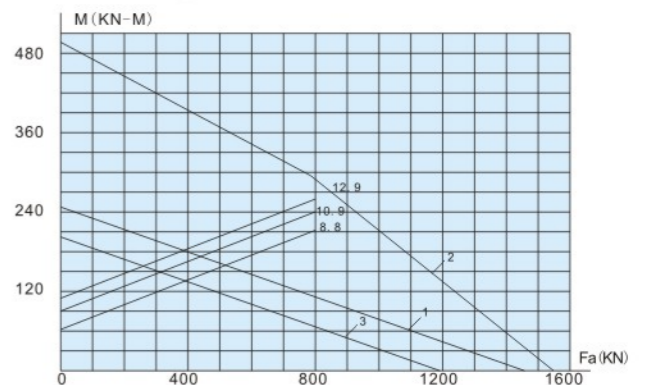

Fig. 1-12 LY-Q035K1

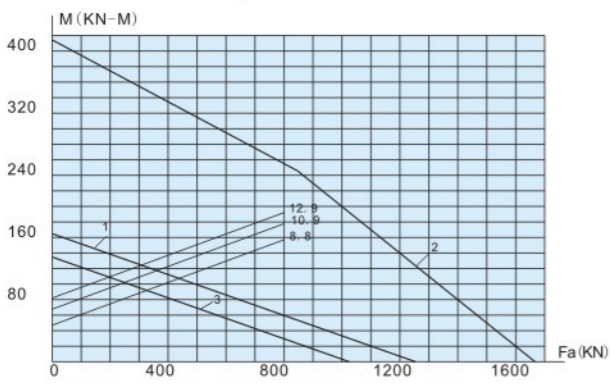

Fig. 1-5 D2787/512

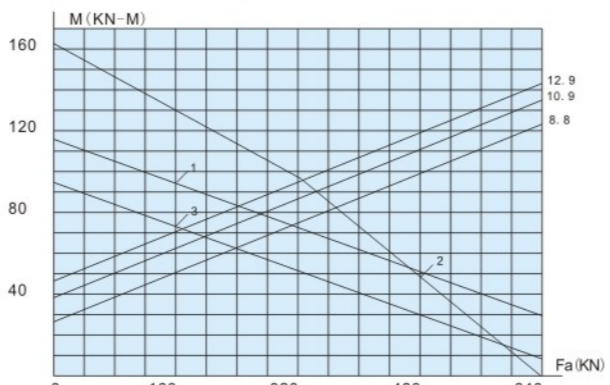

Fig. 1-6 2787/546G2

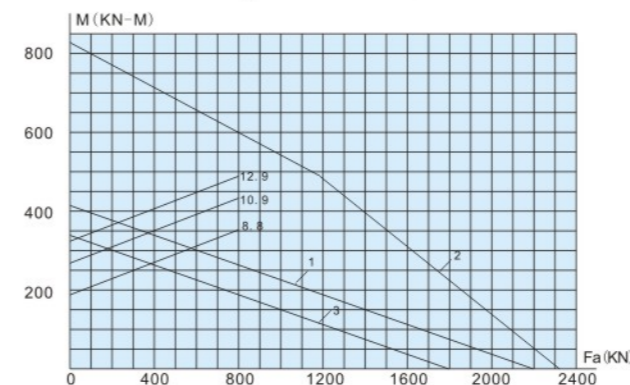

Fig. 1-13 013. 30. 900. 03K/P5

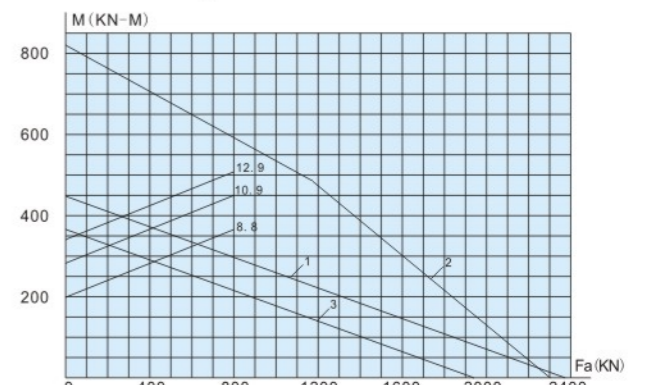

Fig. 1-14 013. 25. 900. 12

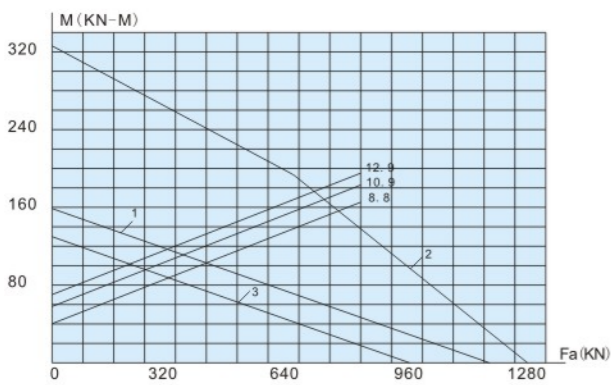

Fig. 1-7 D2787/575

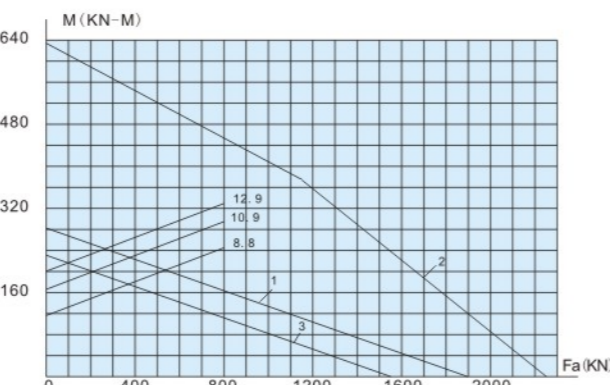

Fig. 1-8 013. 30. 710. 12/P5

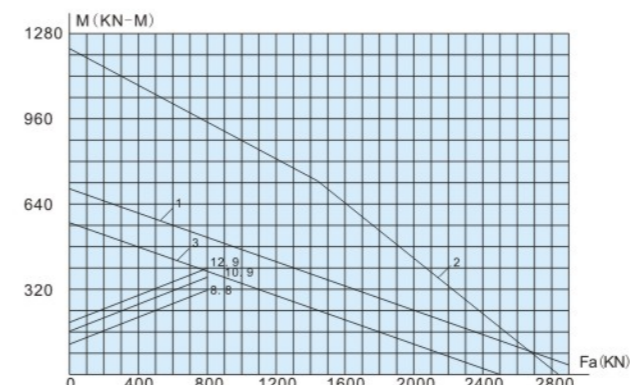

Fig. 1-15 2782/922G2

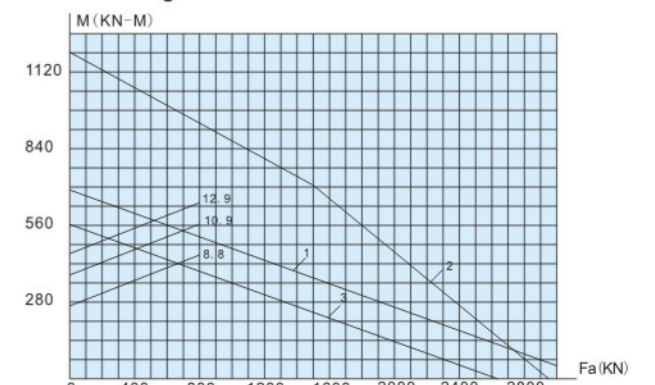

Fig. 1-16 013. 32. 1020. 11



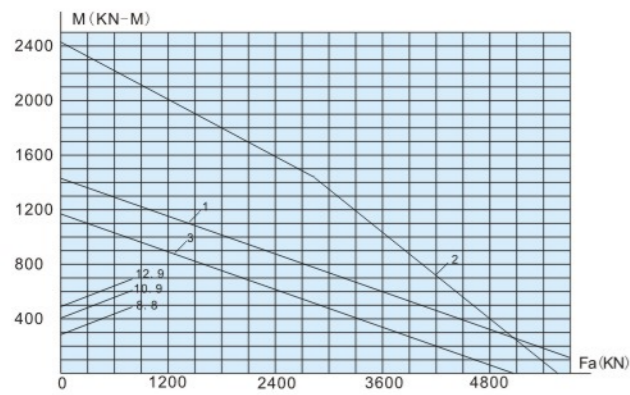

Fig. 1-17 2787/975

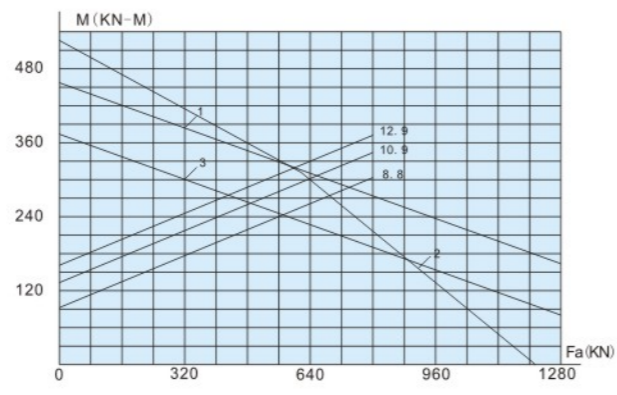

Fig. 1-18 2787/985.6

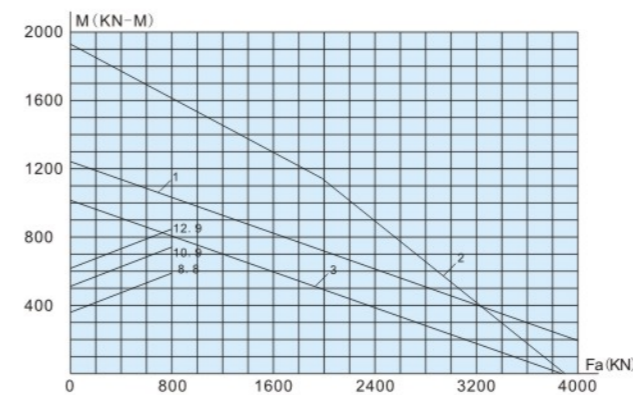

Fig. 1-25 013.40.1250.11

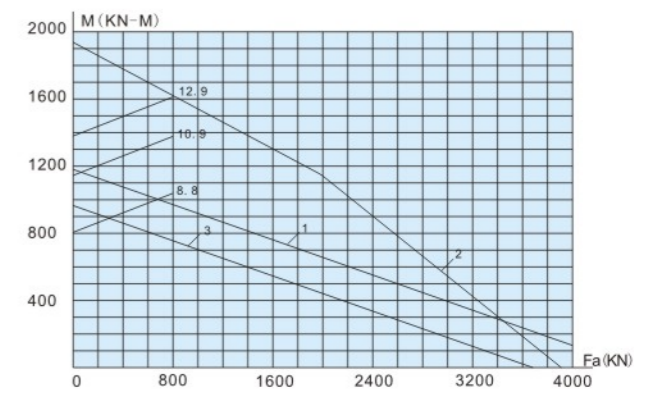

Fig. 1-26 013.45.1250.03K/P5

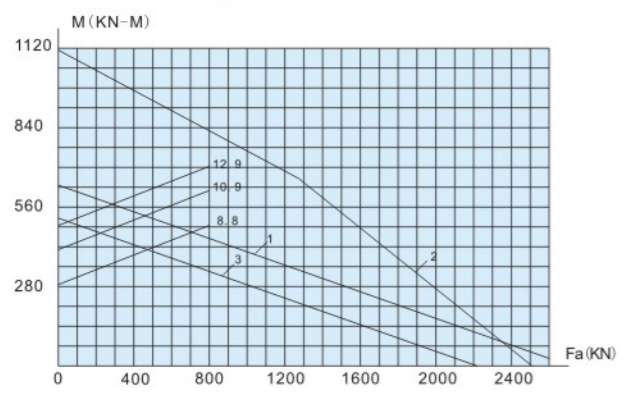

Fig. 1-19 013.30.1120.03K/P5

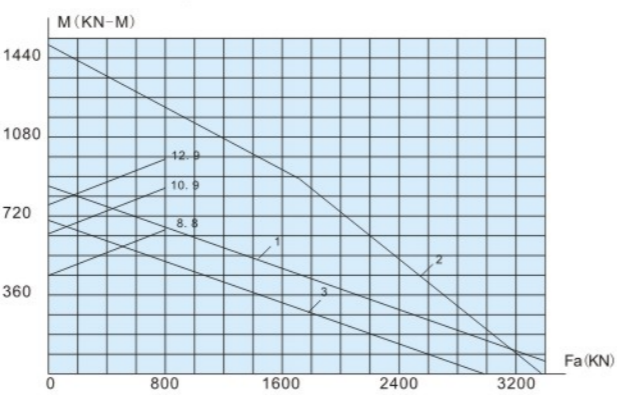

Fig. 1-20 013.40.1120.12

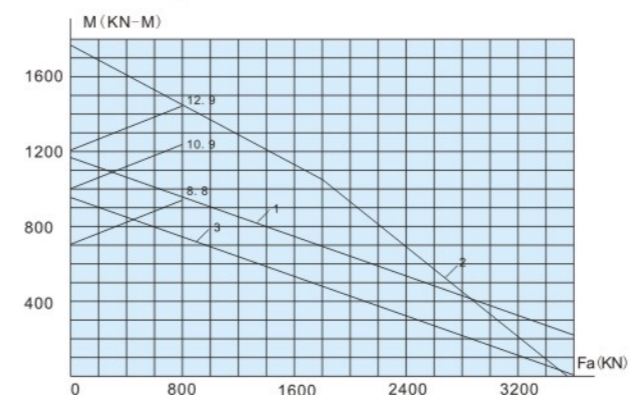

Fig. 1-27 013.35.1257.12

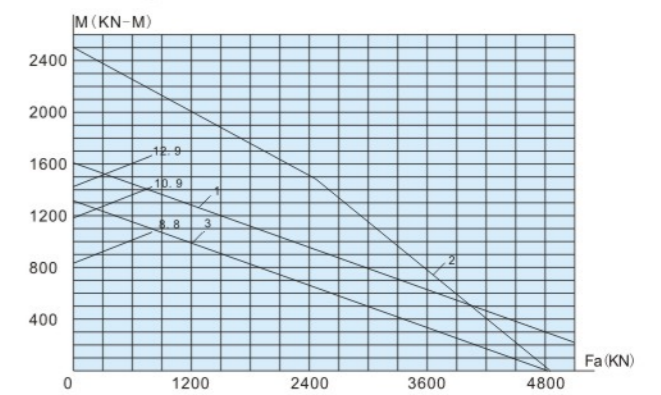

Fig. 1-28 2787/1140

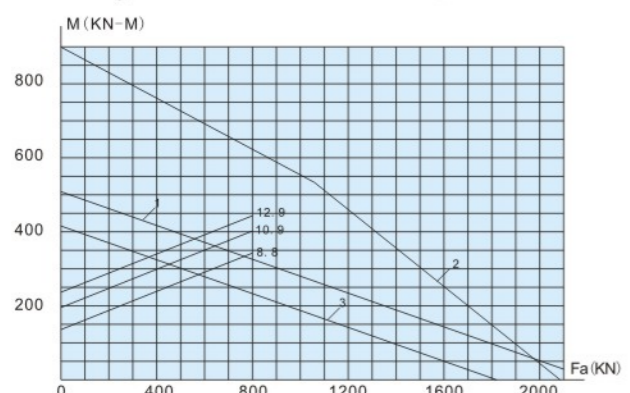

Fig. 1-21 D2787/1010

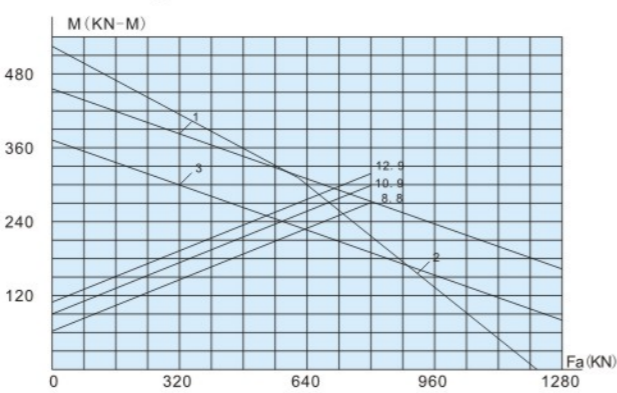

Fig. 1-22 LY-Q036

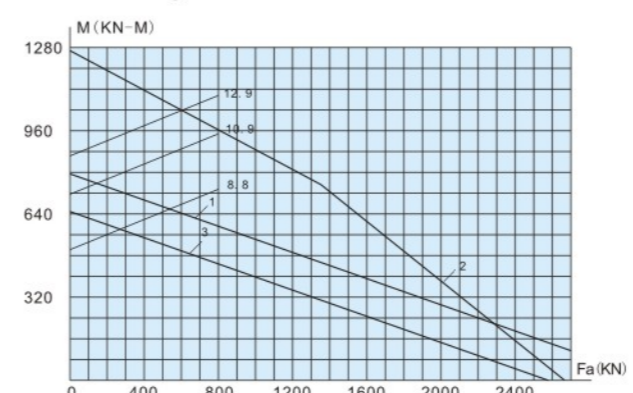

Fig. 1-29 2787/1083.7

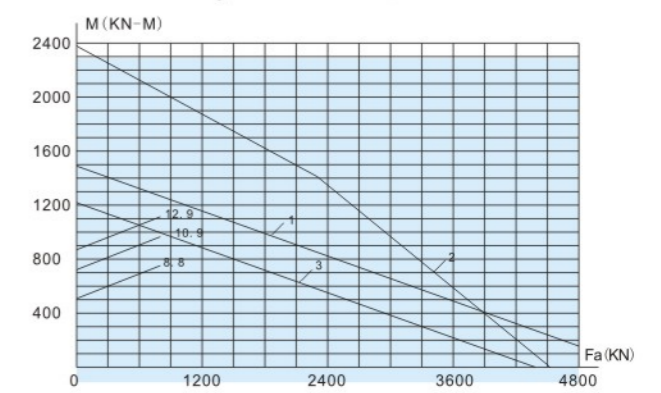

Fig. 1-30 D2787/1180K

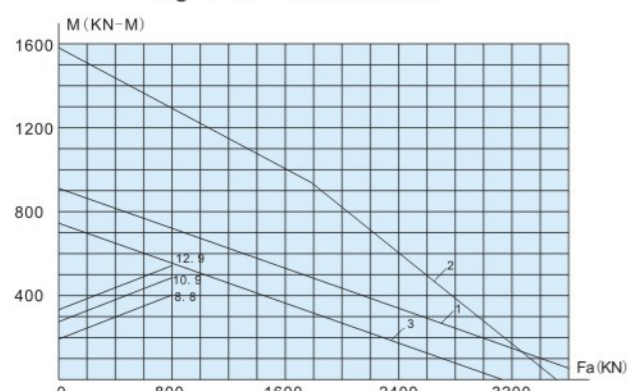

Fig. 1-23 2782/1000GK

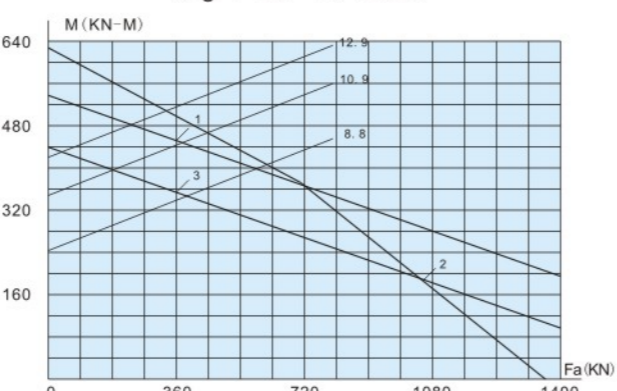

Fig. 1-24 2787/1020G2

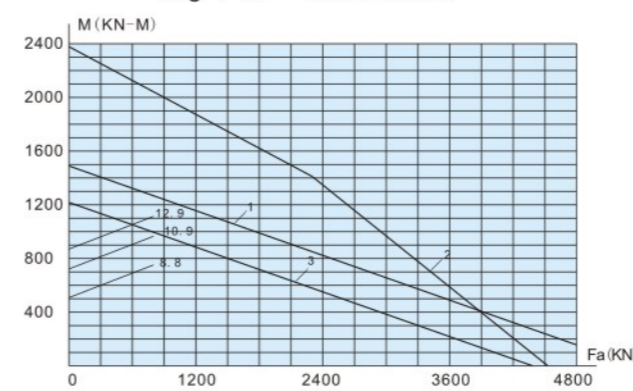

Fig. 1-31 D2787/1180

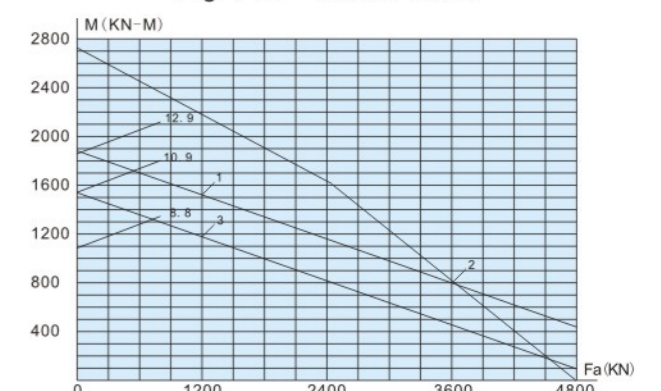

Fig. 1-32 2787/1190



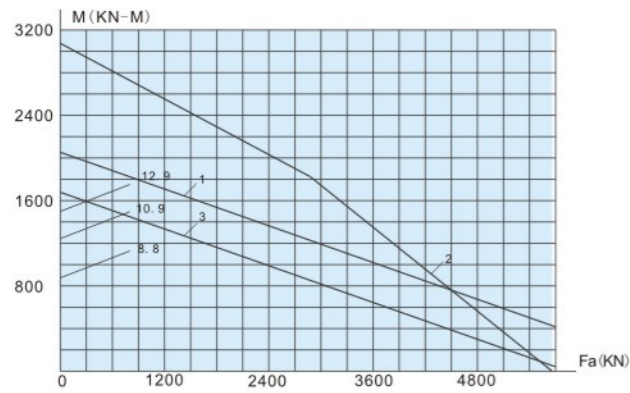

Fig. 1-33 2787/1210G2

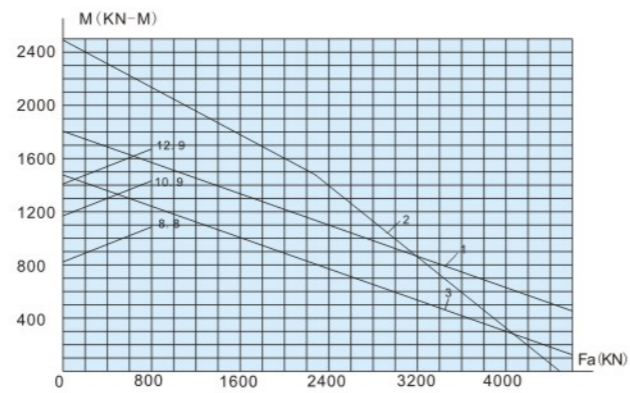

Fig. 1-34 013.40.1400.11

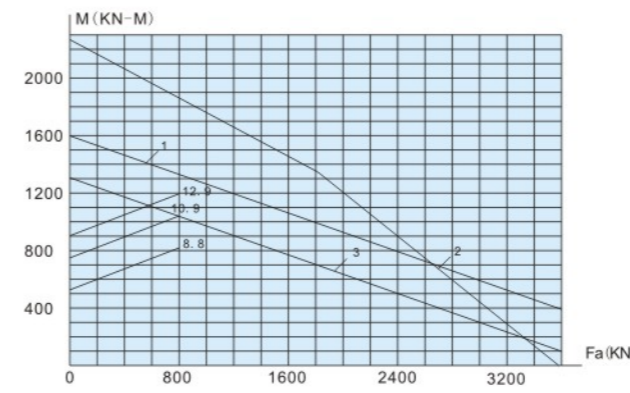

Fig. 1-41 2787/1400K1

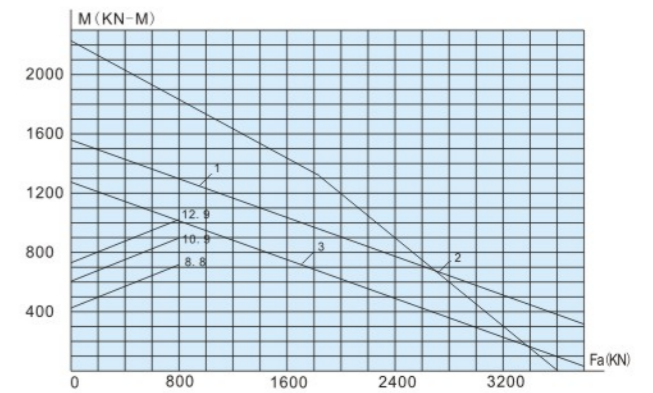

Fig. 1-42 2787/1400GK

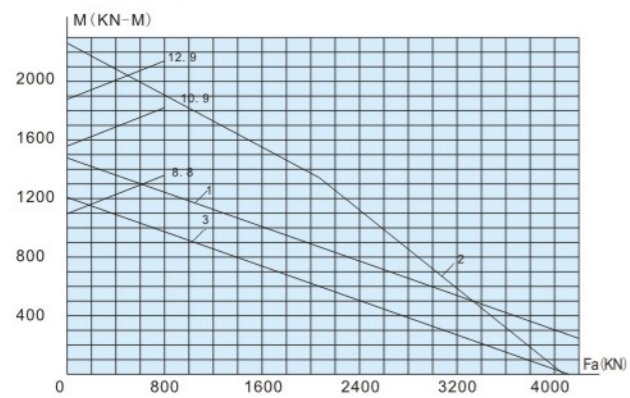

Fig. 1-35 013.45.1400.12K

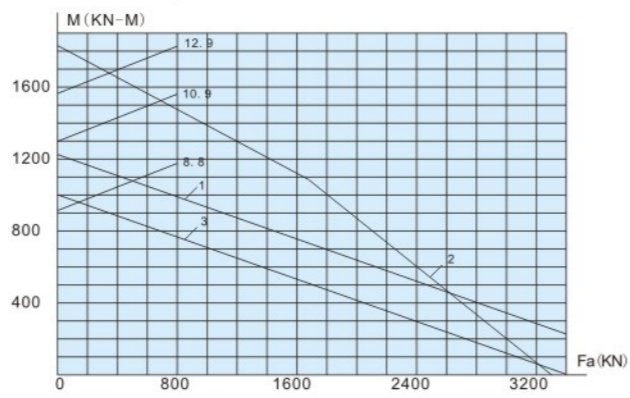

Fig. 1-36 013.35.1400.03/P5

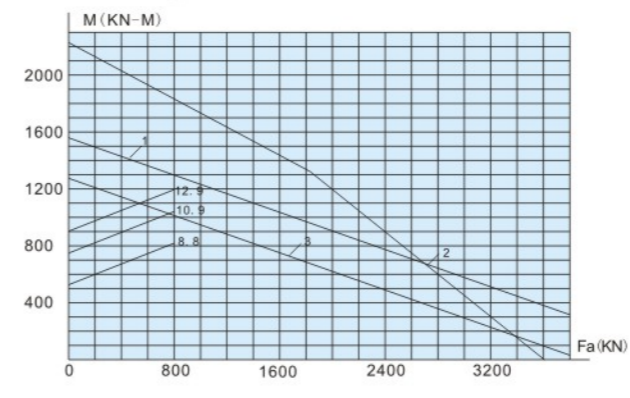

Fig. 1-43 2787/1400GK1

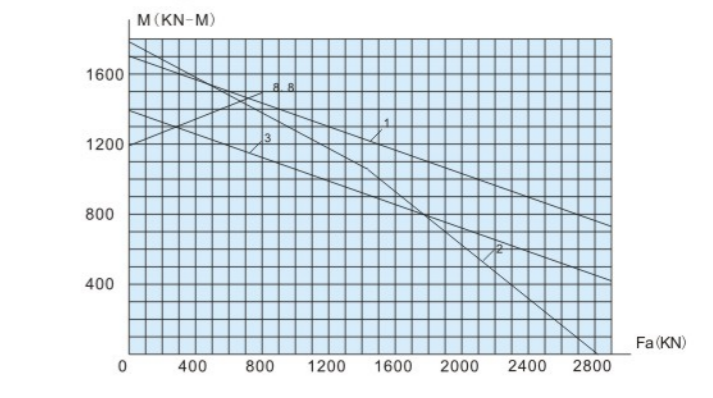

Fig. 1-44 014.30.1600.11K

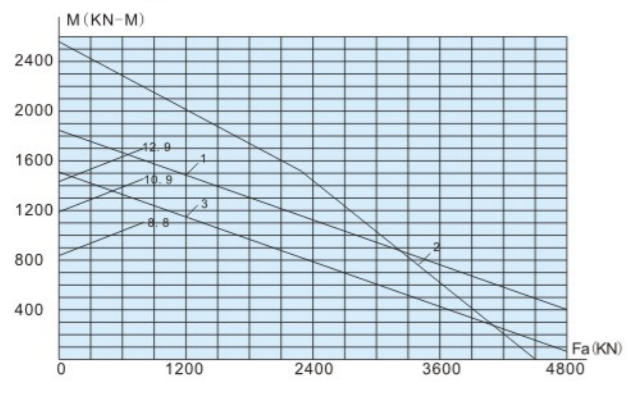

Fig. 1-37 013.40.1435.11

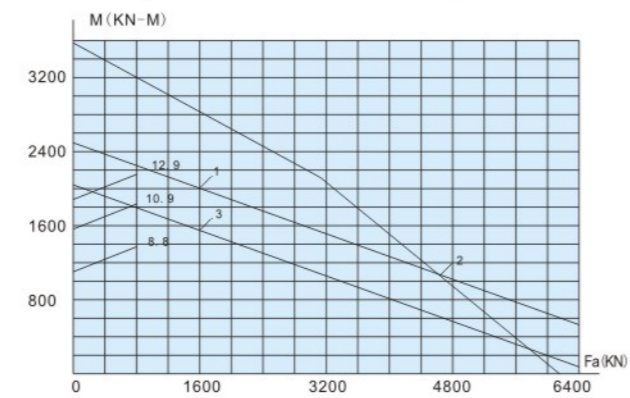

Fig. 1-38 013.60.1465.03

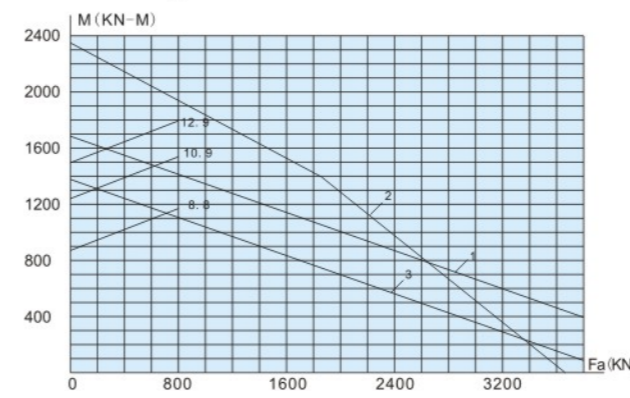

Fig. 1-45 2787/1440

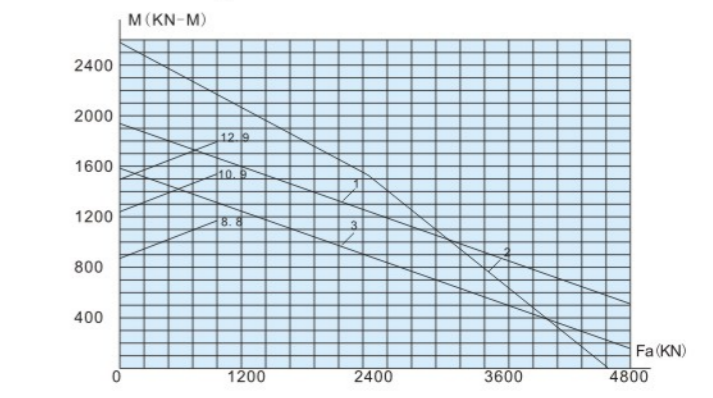

Fig. 1-46 D2787/1440G

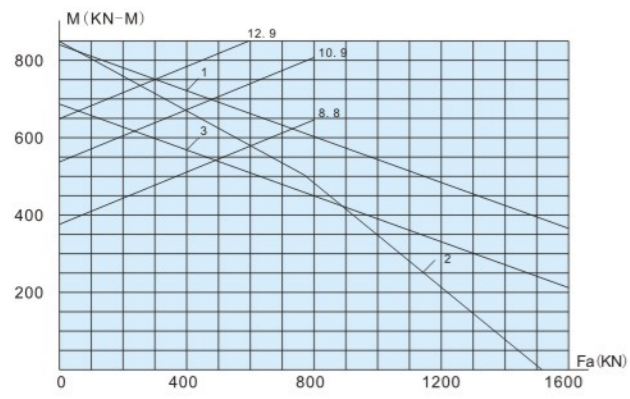

Fig. 1-39 E2787/1300

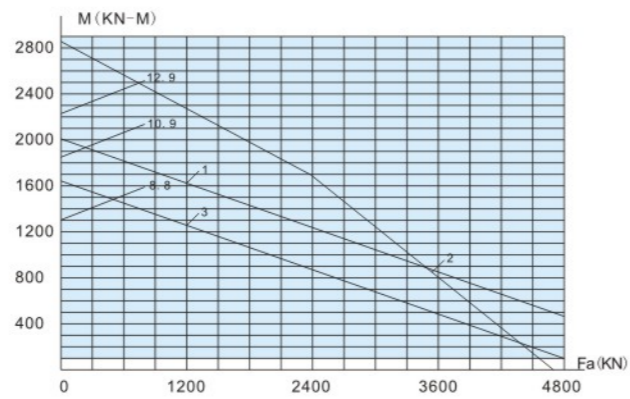

Fig. 1-40 2787/1278

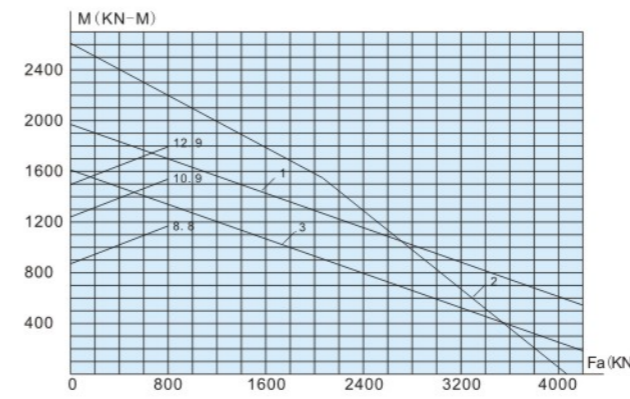

Fig. 1-47 2768/1440G

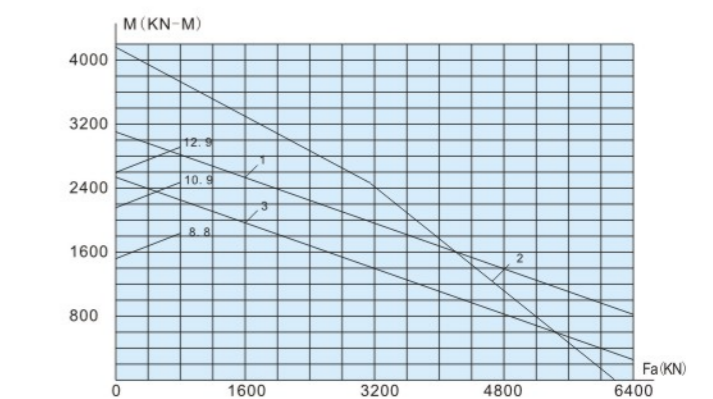

Fig. 1-48 2787/1525G2



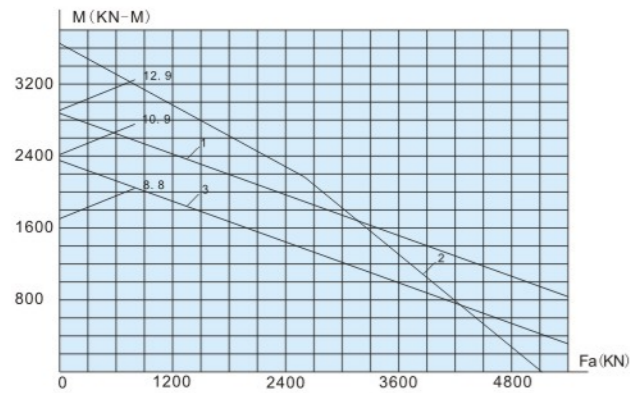

Fig. 1-49 013.45.1800.03K1

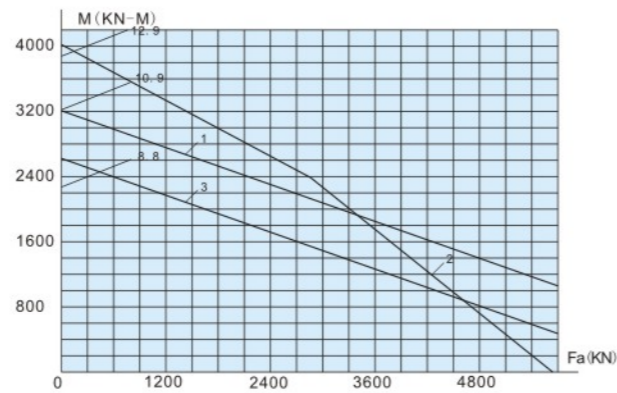

Fig. 1-50 013.50.1800.03

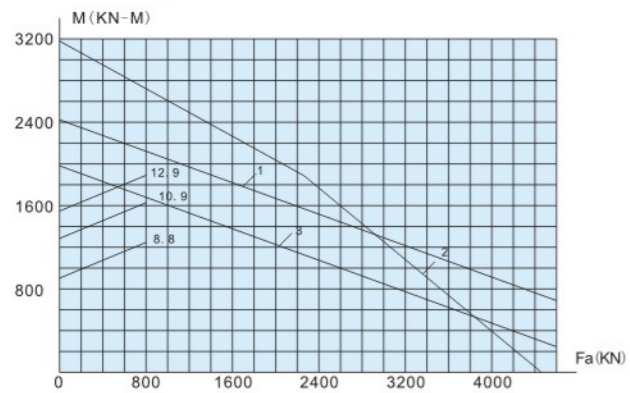

Fig. 1-51 013.45.1800.03K

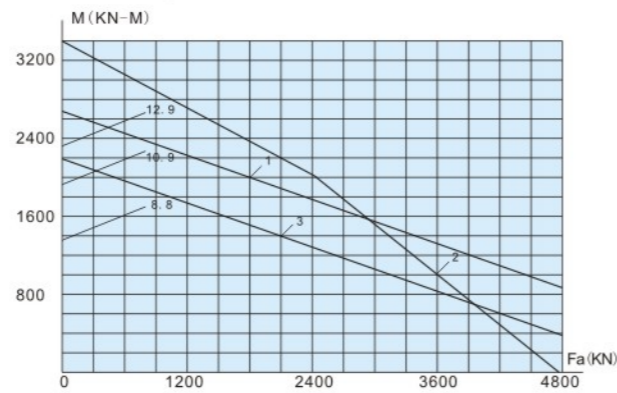

Fig. 1-52 014.45.1800.03K

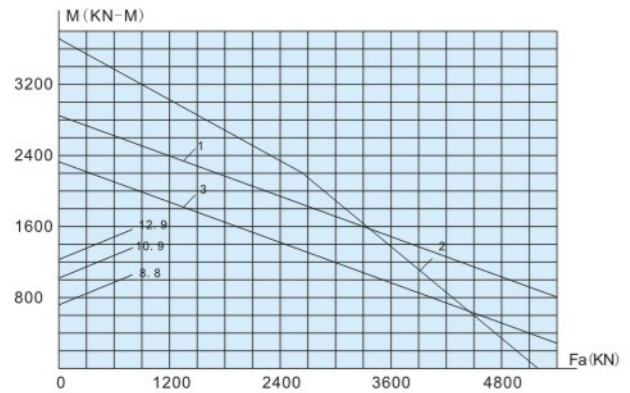

Fig. 1-53 D2787/1650

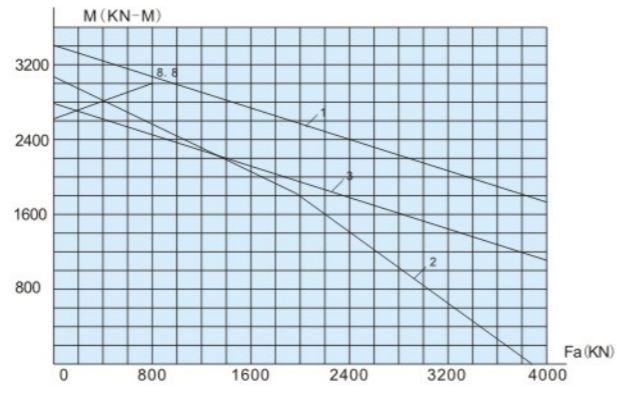

Fig. 1-54 2787/1833

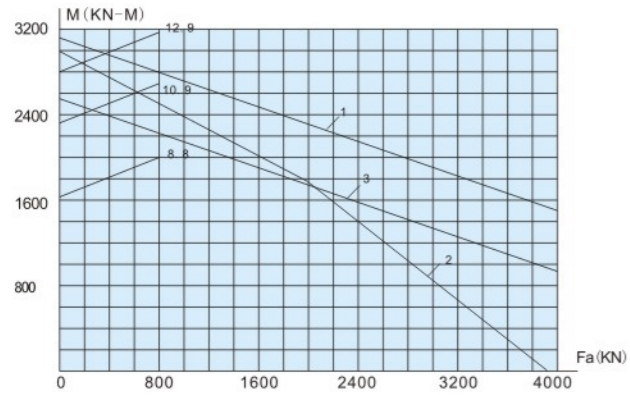

Fig. 1-55 2788/1730G2

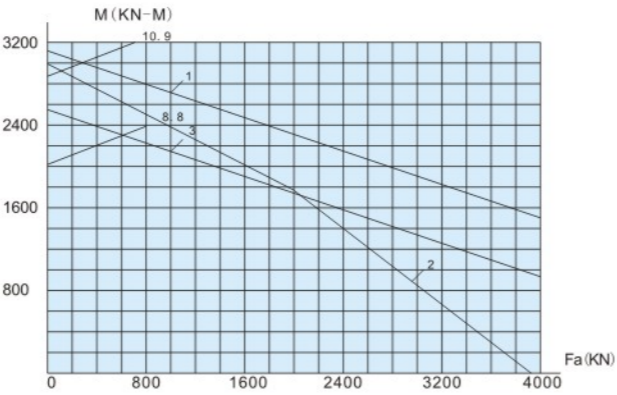

Fig. 1-56 2788/1712K

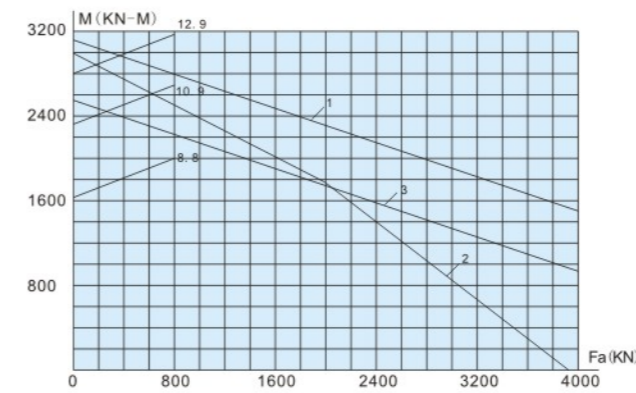

Fig. 1-57 2788/1712

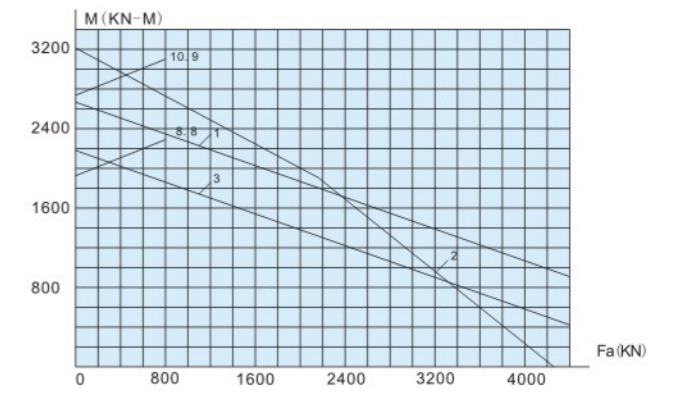

Fig. 1-58 2787/1758

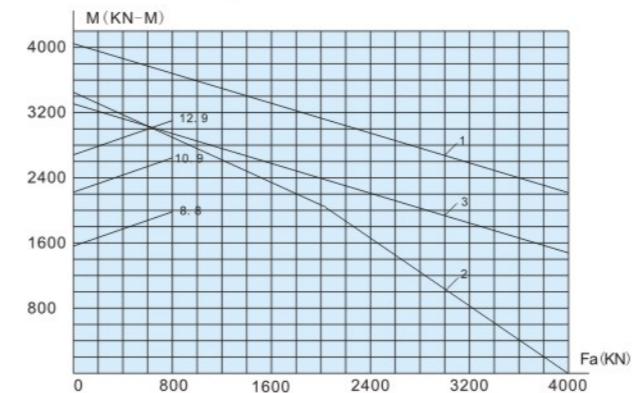

Fig. 1-59 2787/2057

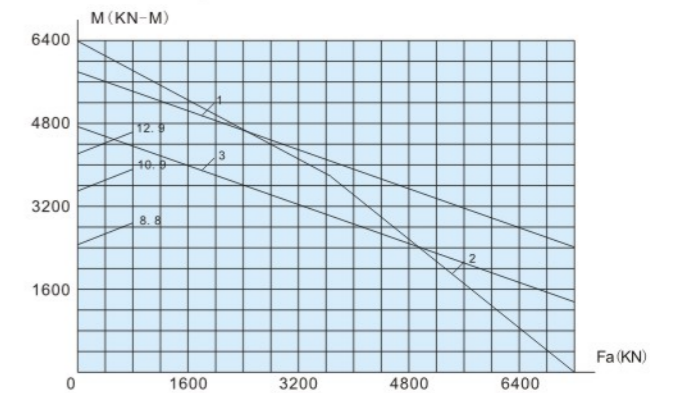

Fig. 1-60 014.60.2240.03

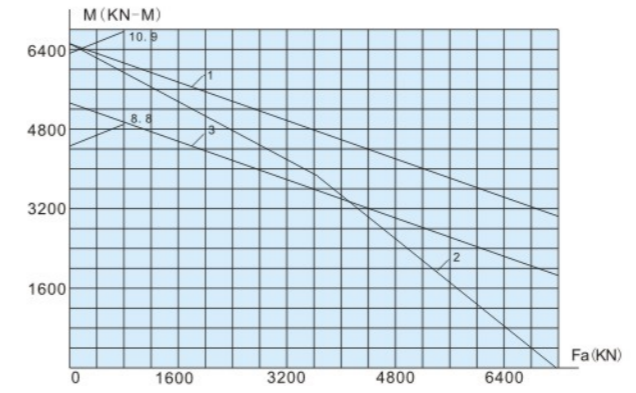

Fig. 1-61 2787/2121

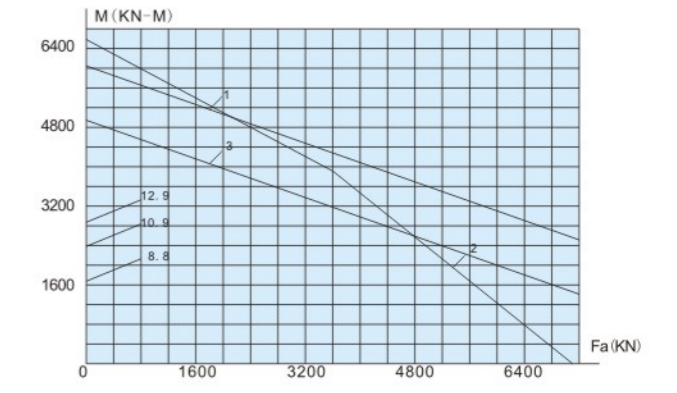

Fig. 1-62 2789/2230

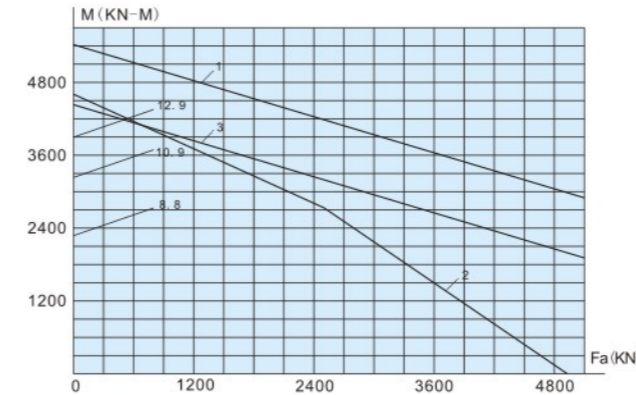

Fig. 1-63 2789/2240

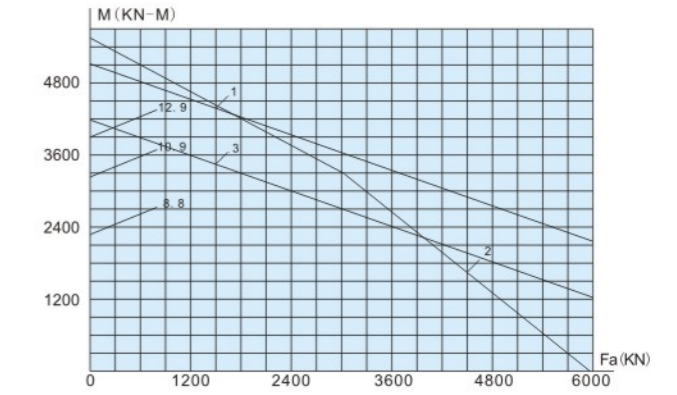

Fig. 1-64 2789/2240G2K



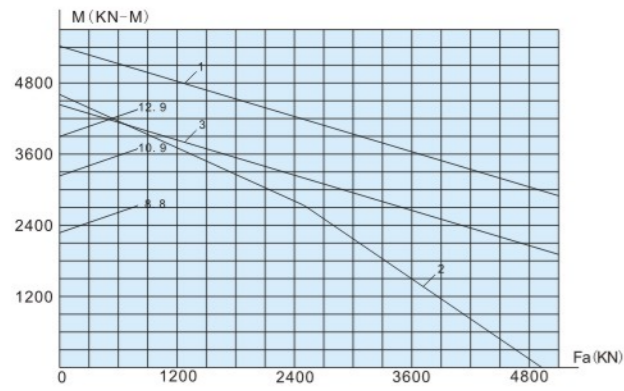

Fig. 1-65 2789/2240G2

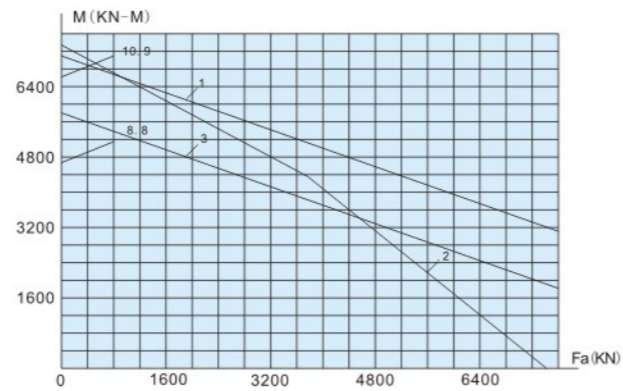

Fig. 1-66 014. 60. 2500. 03K

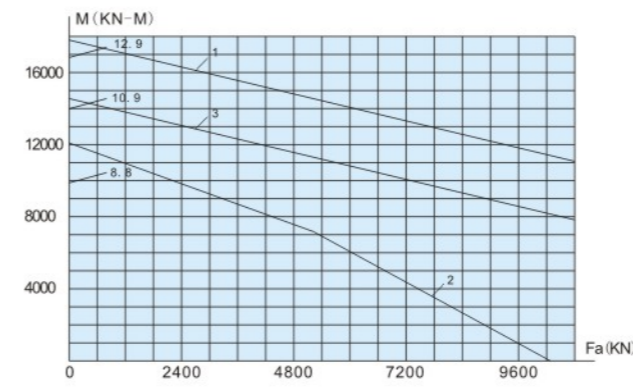

Fig. 1-73 013. 70. 2970. 03K

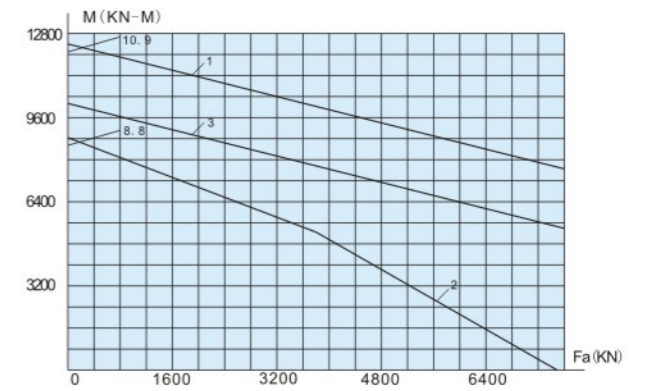

Fig. 1-74 2787/2760

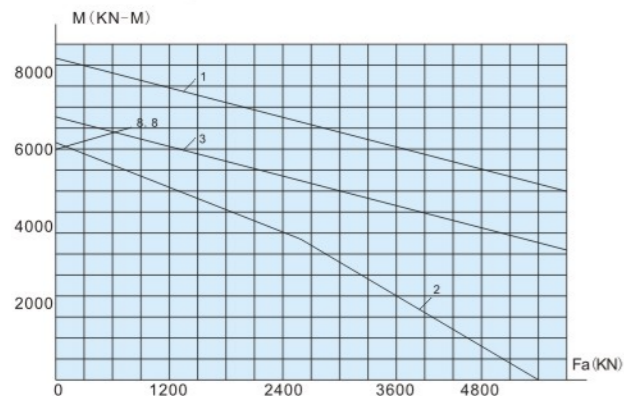

Fig. 1-67 2787/2553

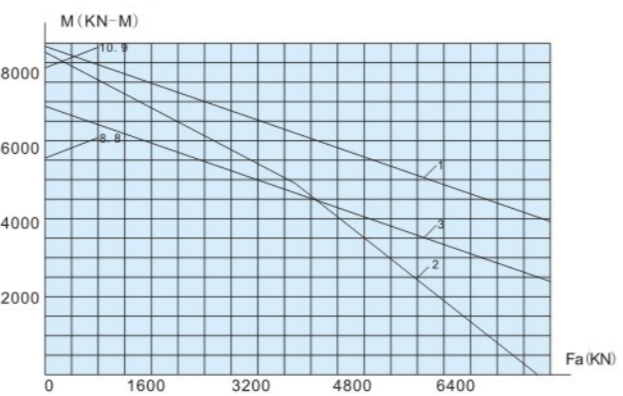

Fig. 1-68 013. 60. 2820. 03

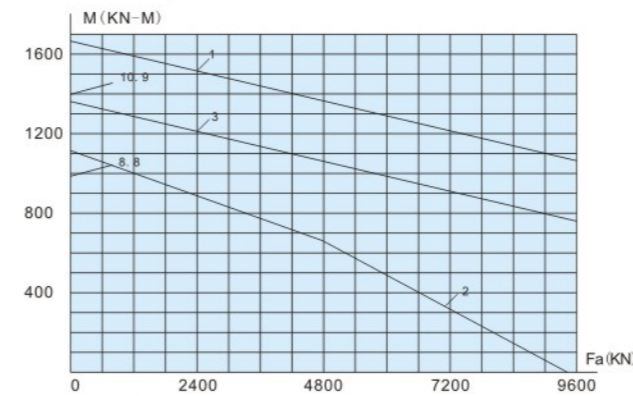

Fig. 1-75 013. 63. 2990. 03

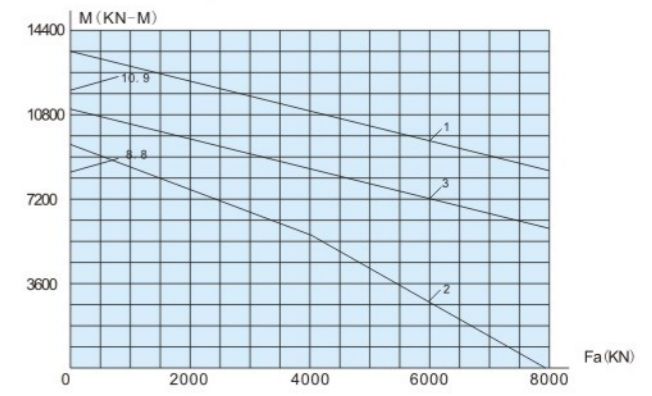

Fig. 1-76 2787/2845

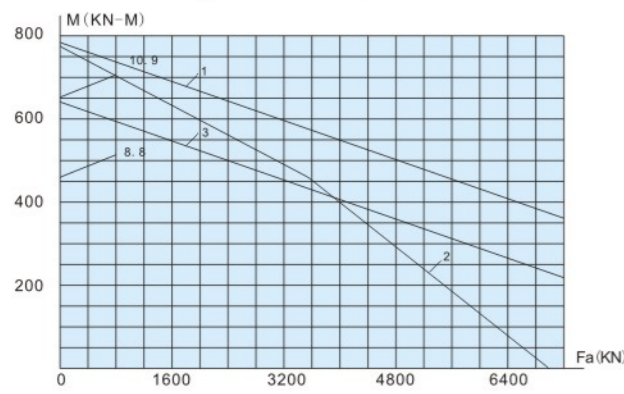

Fig. 1-69 013. 60. 2800. 12K/P5

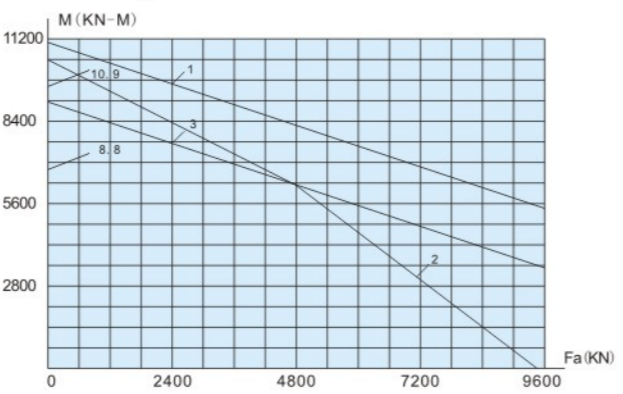

Fig. 1-70 2787/2687

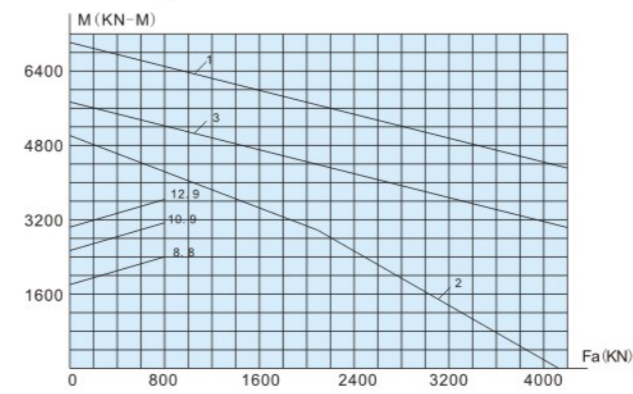

Fig. 1-77 013. 35. 3070. 03/P6

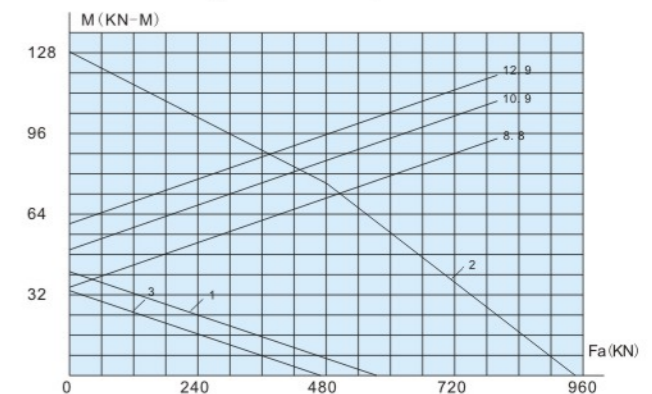

Fig. 1-78 D1787/267M

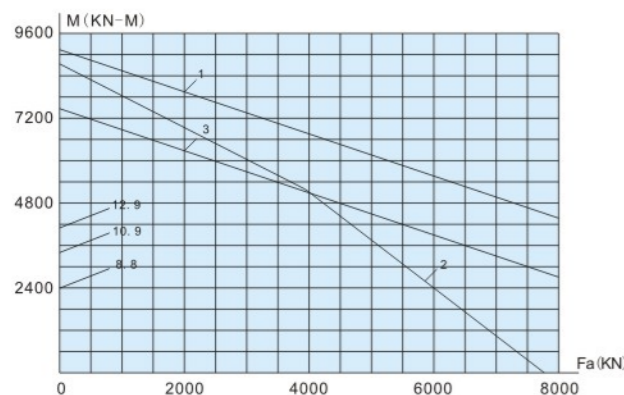

Fig. 1-71 2789/2735

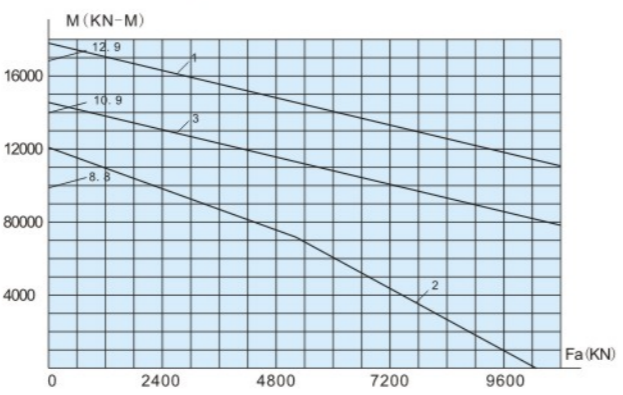

Fig. 1-72 013. 70. 2970. 03

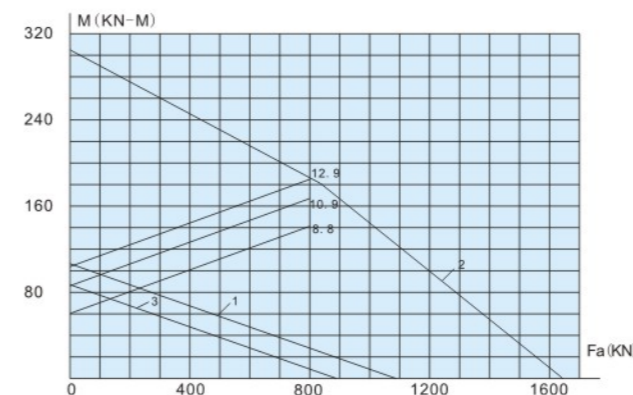

Fig. 1-79 011. 25. 467. 03

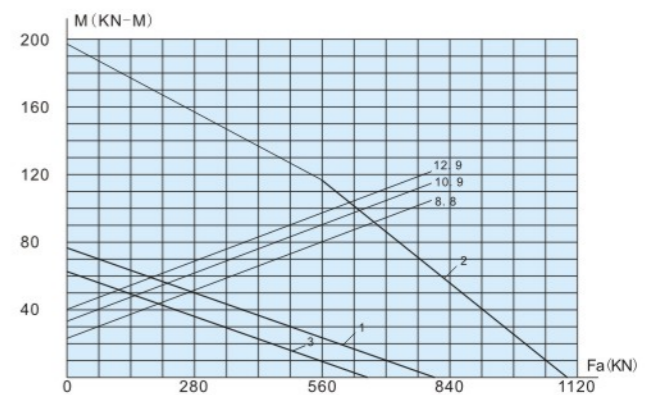

Fig. 1-80 D1787/380



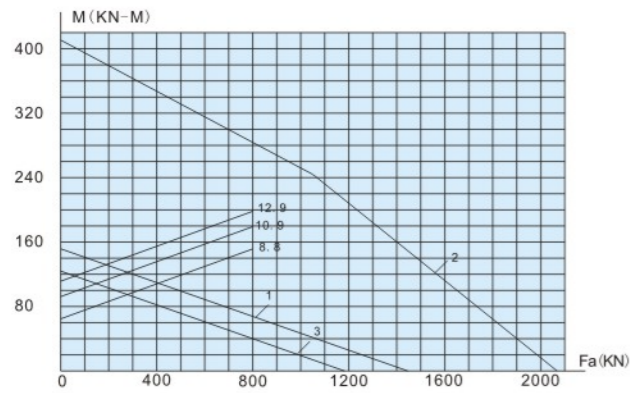

Fig. 1-81 012.30.500.12

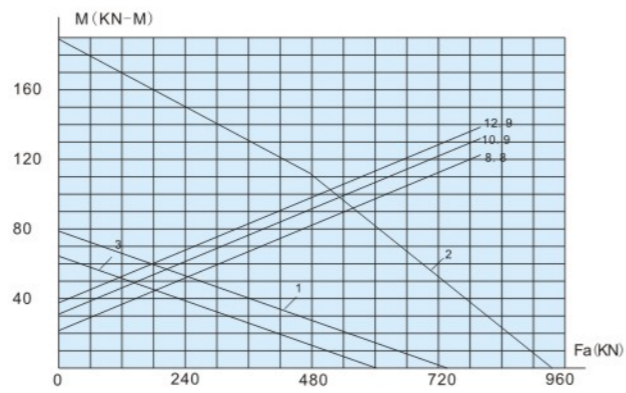

Fig. 1-82 011.18.510.03/P5

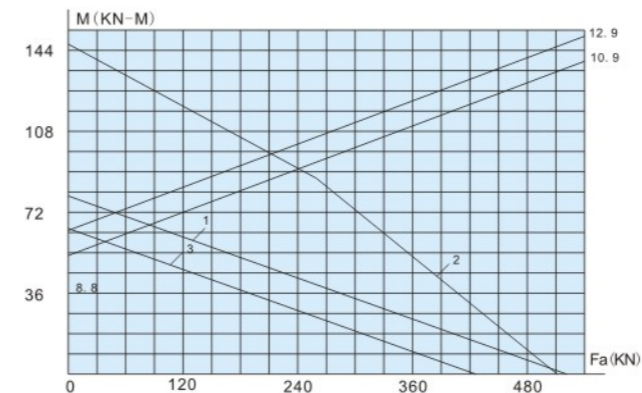

Fig. 1-89 1787/600

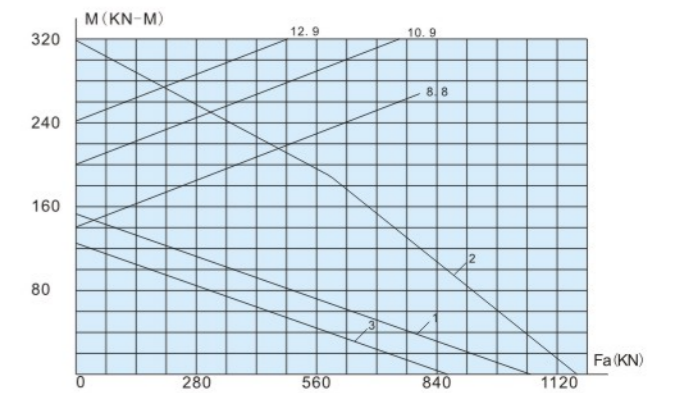

Fig. 1-90 1787/600G

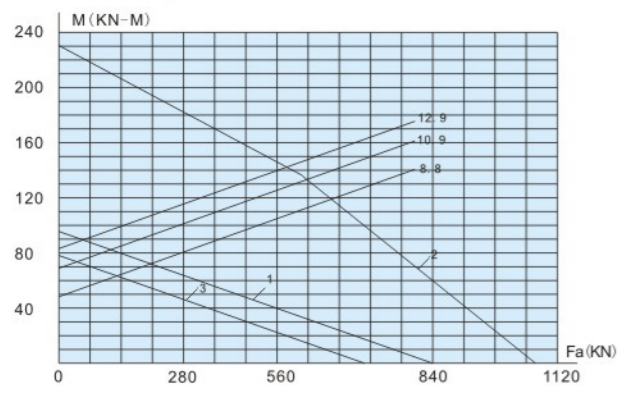

Fig. 1-83 1787/434

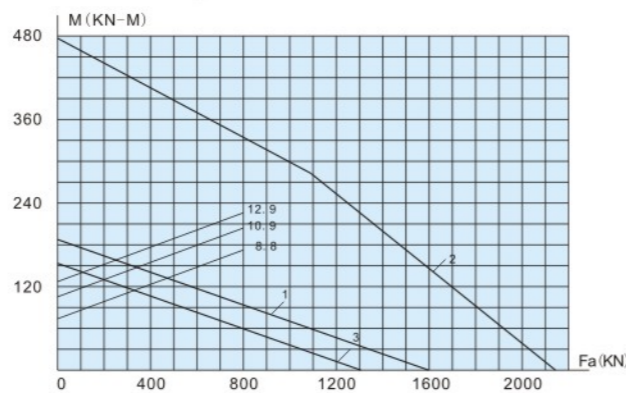

Fig. 1-84 011.30.560.03/P5

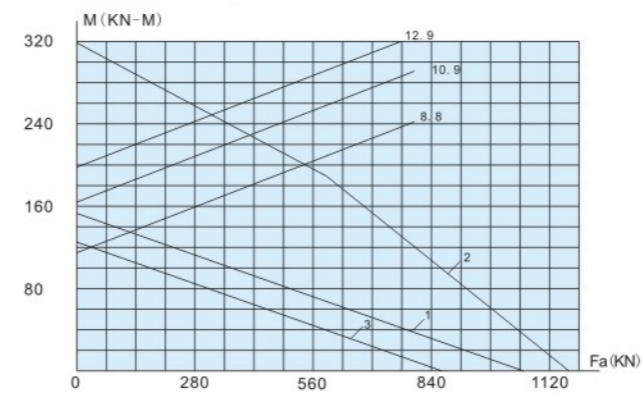

Fig. 1-91 E1787/600G2K1

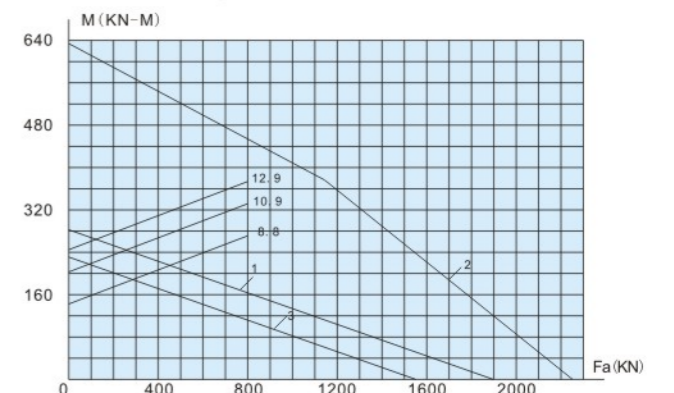

Fig. 1-92 011.30.710.12

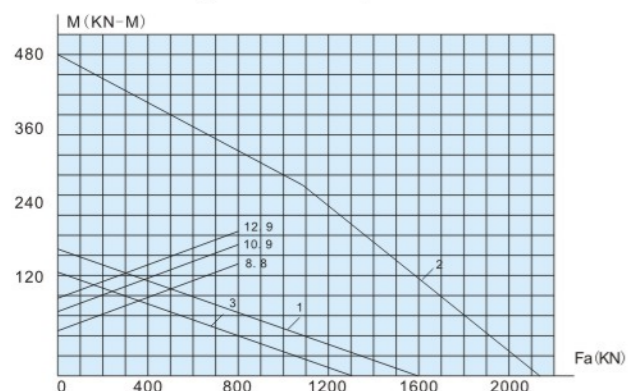

Fig. 1-85 D178794

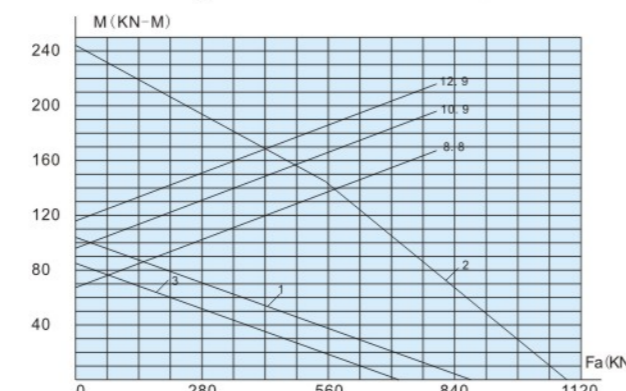

Fig. 1-86 D178794K1

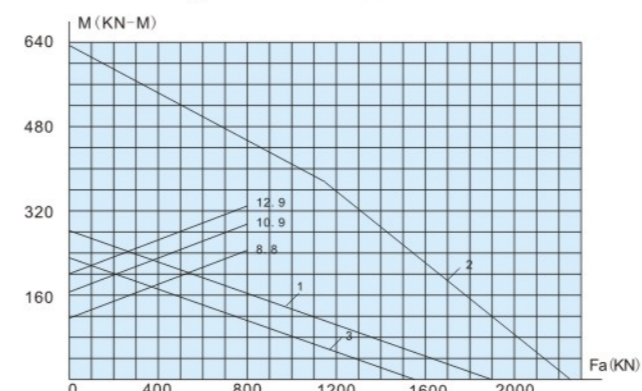

Fig. 1-93 012.30.710.03

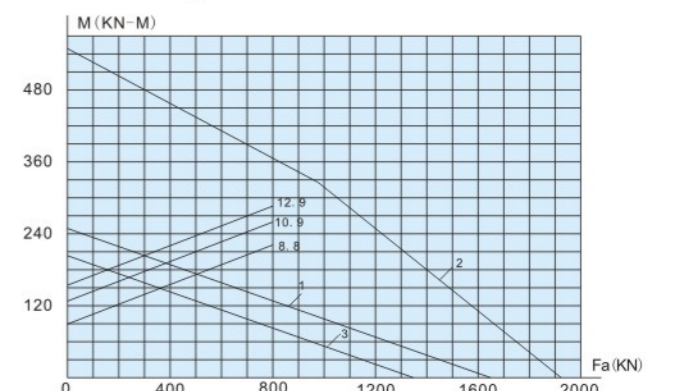

Fig. 1-94 011.25.720.12

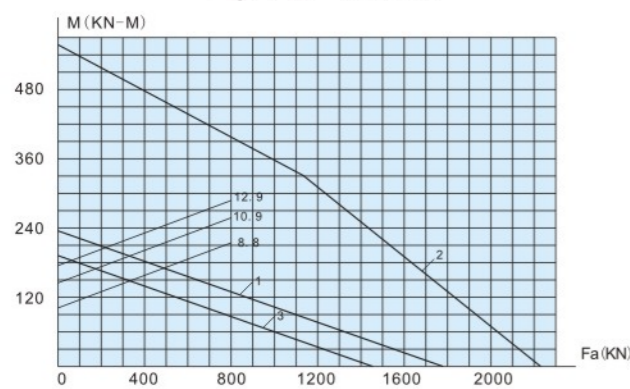

Fig. 1-87 011.30.630.12

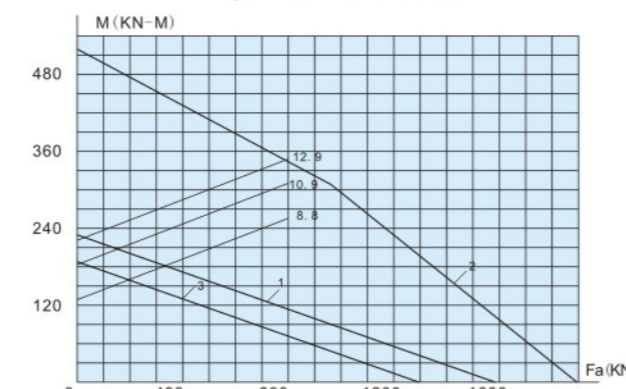

Fig. 1-88 011.25.692.12

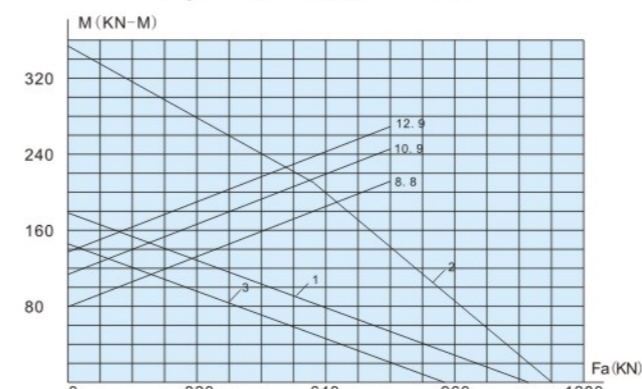

Fig. 1-95 011.20.745.03

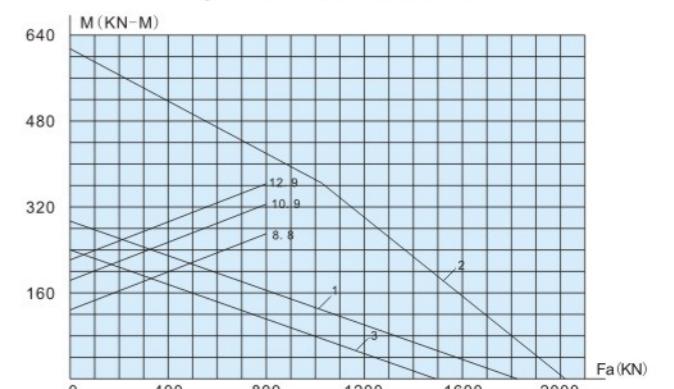

Fig. 1-96 1787/674G2K



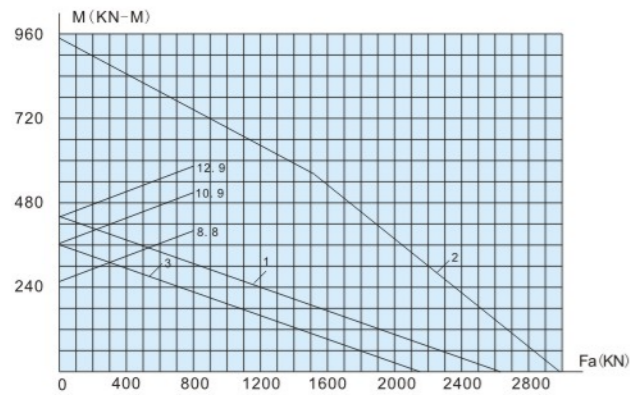

Fig. 1-97 011. 40. 800. 12

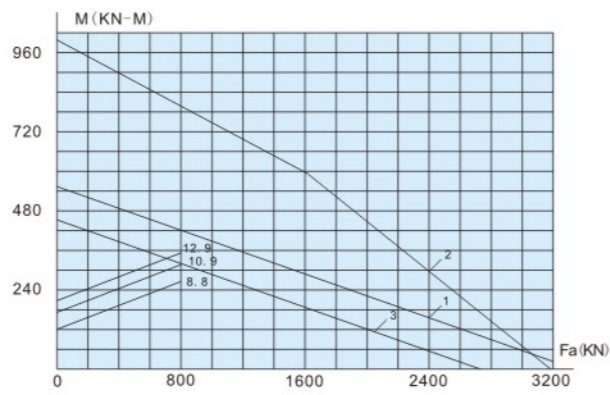

Fig. 1-98 1787/690K

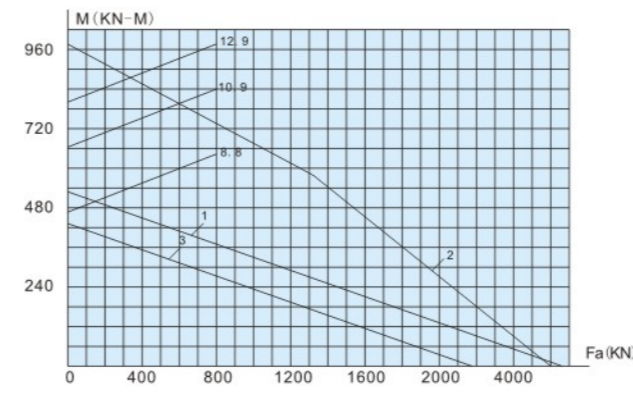

Fig. 1-105 D1787/835

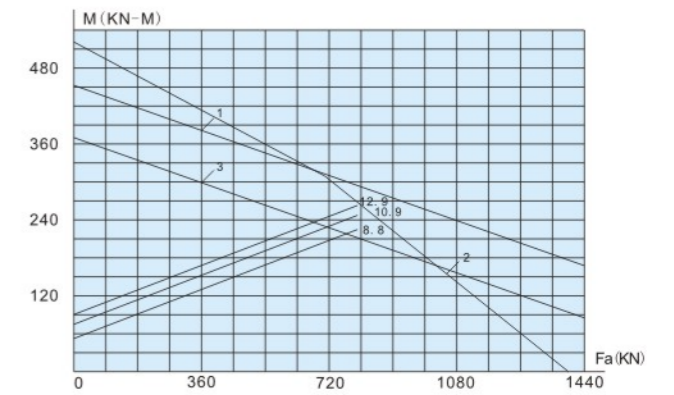

Fig. 1-106 011. 20. 945. 03

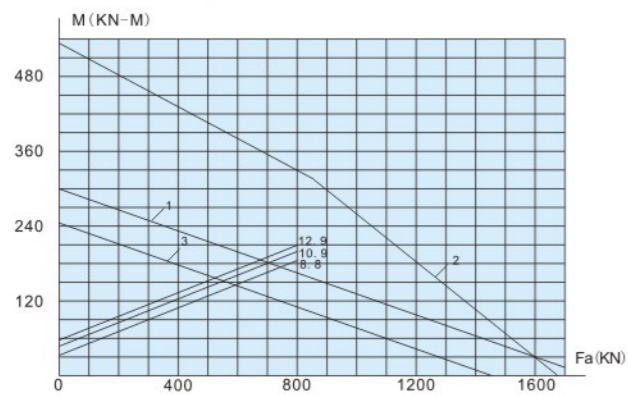

Fig. 1-99 1787/710G2K

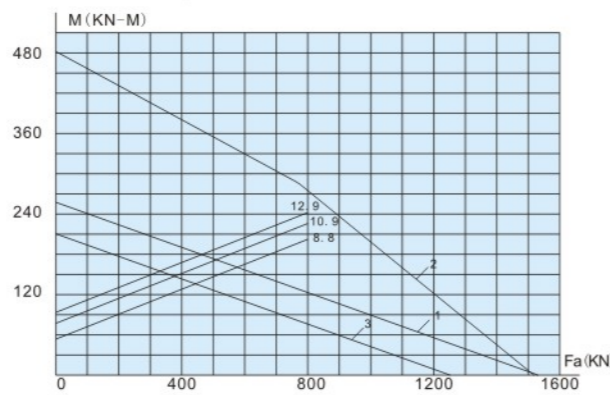

Fig. 1-100 1787/710G2K1

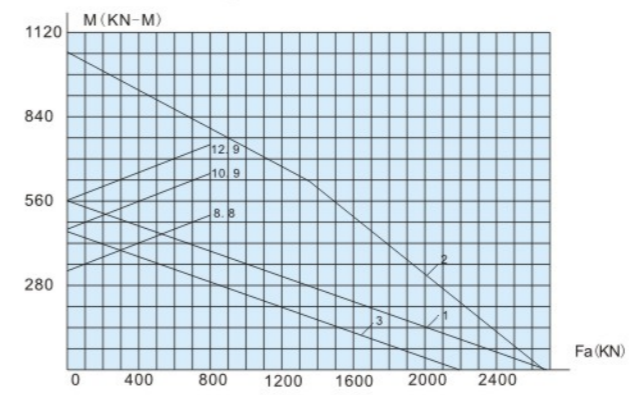

Fig. 1-107 E1787/876G2

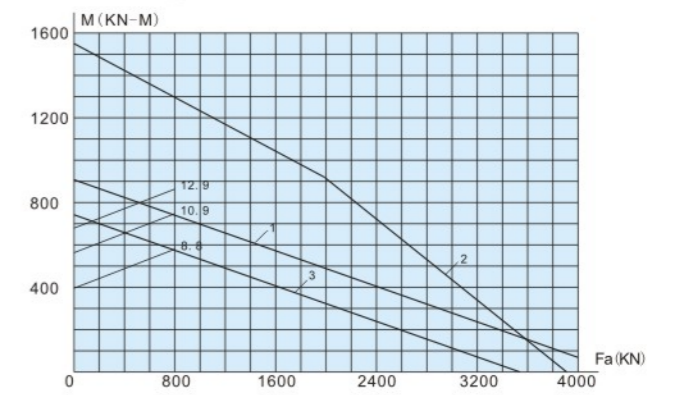

Fig. 1-108 011. 40. 1000. 12

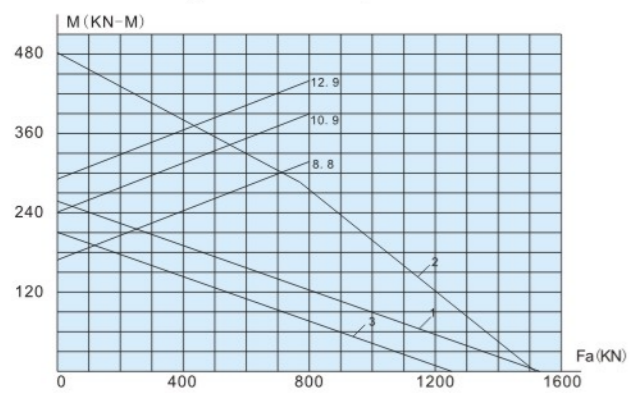

Fig. 1-101 1787/710G2K2

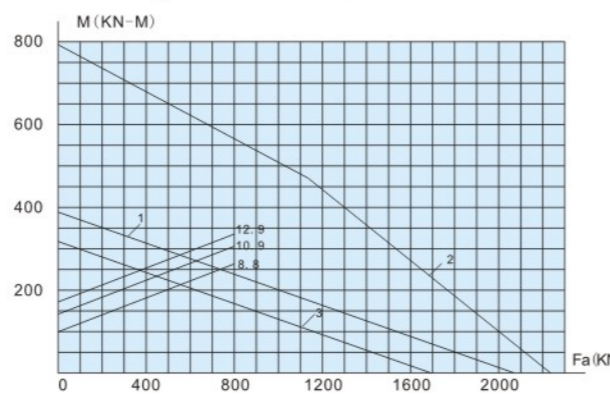

Fig. 1-102 011. 30. 895. 03/P5

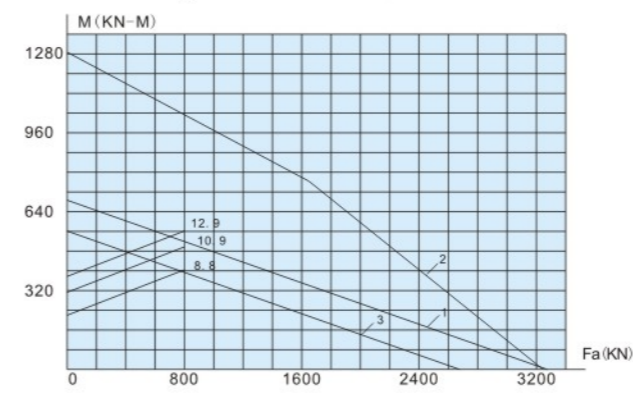

Fig. 1-109 011. 40. 1000. 12K

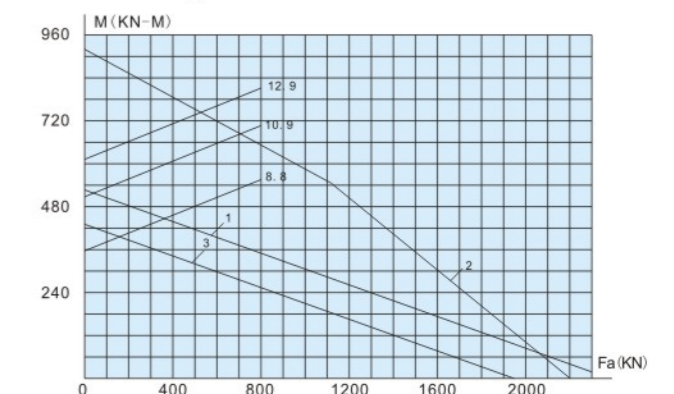

Fig. 1-110 011. 25. 1055. 03

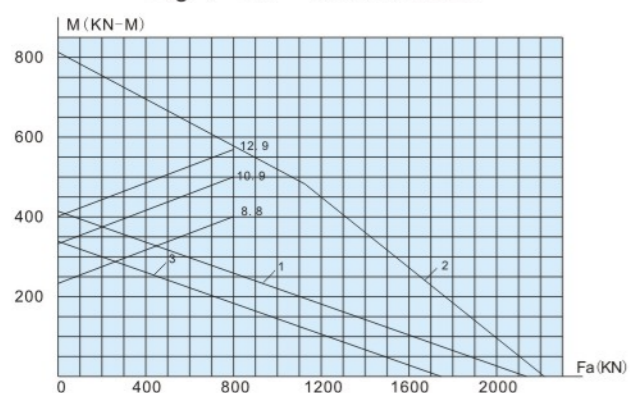

Fig. 1-103 1787/800G

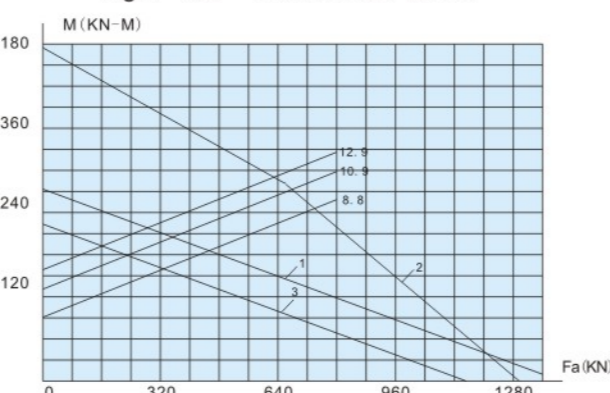

Fig. 1-104 1787/800G2

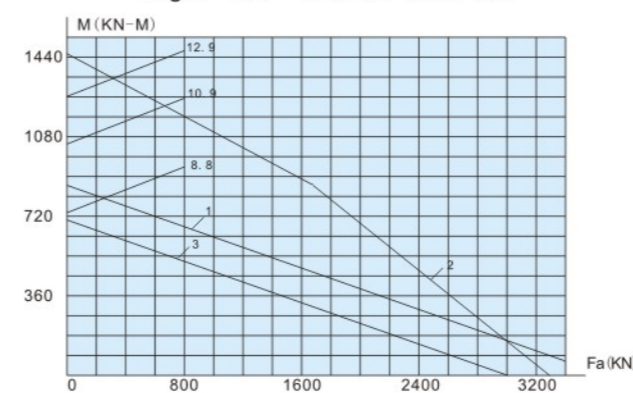

Fig. 1-111 011. 35. 1116. 03

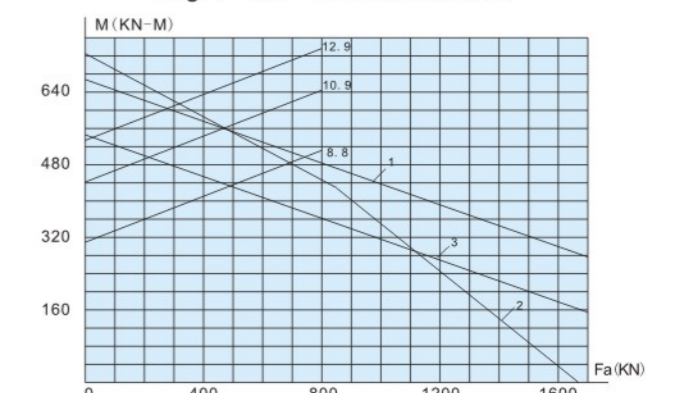

Fig. 1-112 011. 20. 1097. 03



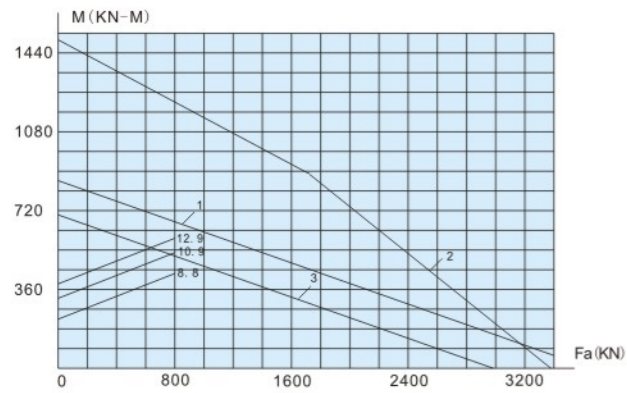

Fig. 1-113 011.40.1120.12K

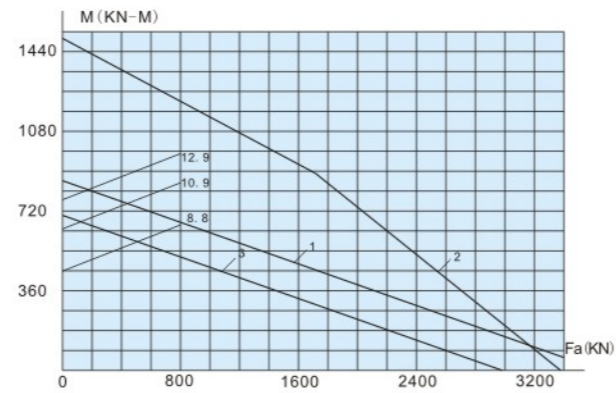

Fig. 1-114 011.40.1120.12K1

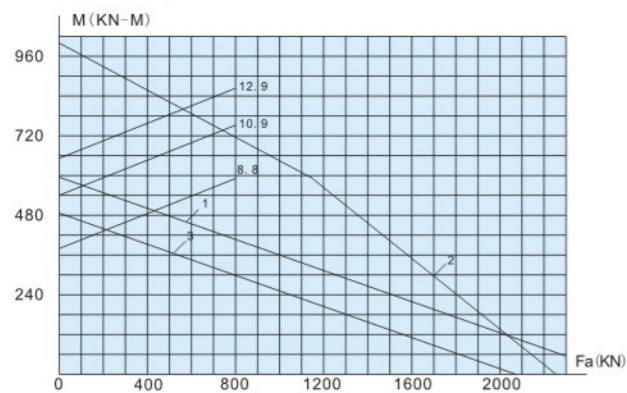

Fig. 1-115 011.25.1120.12

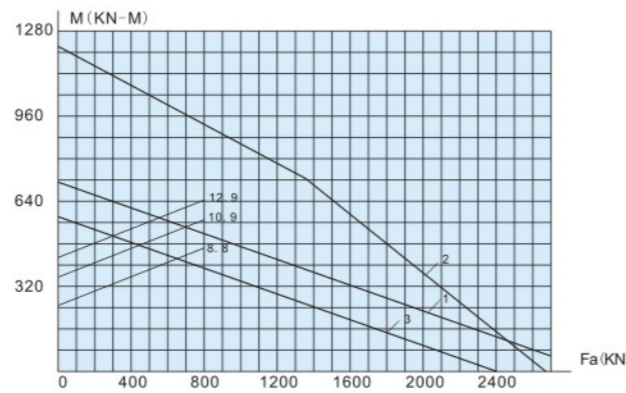

Fig. 1-116 1788/1040G2

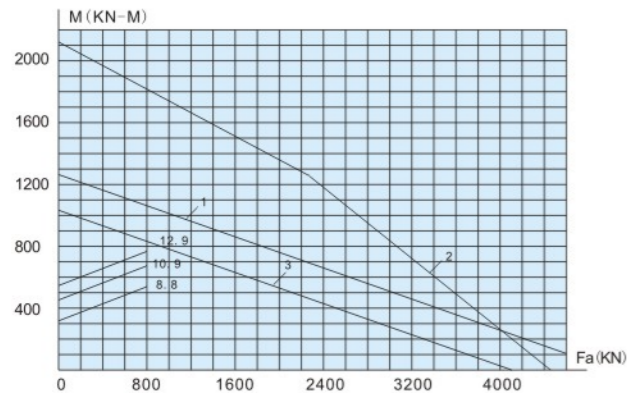

Fig. 1-117 1787/1060G

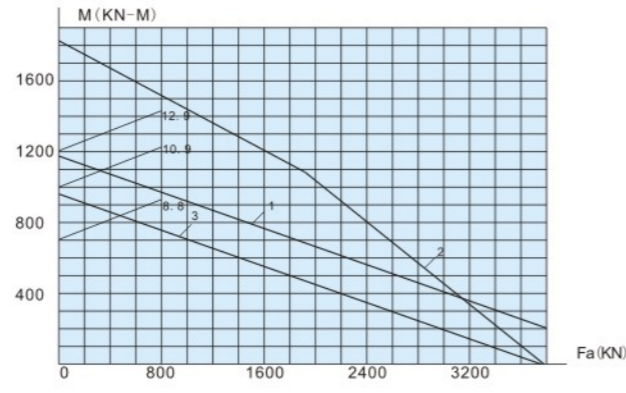

Fig. 1-118 D1787/1075

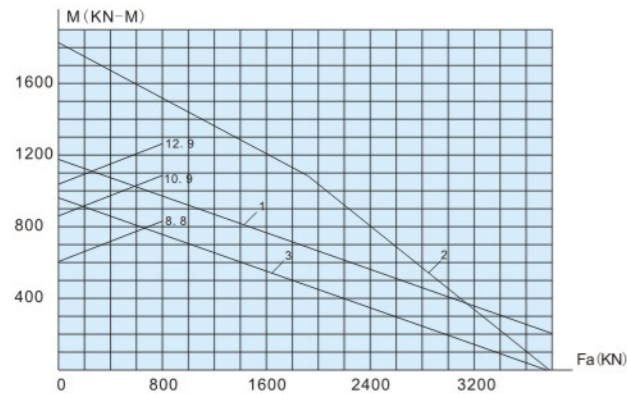

Fig. 1-119 1787/1075K

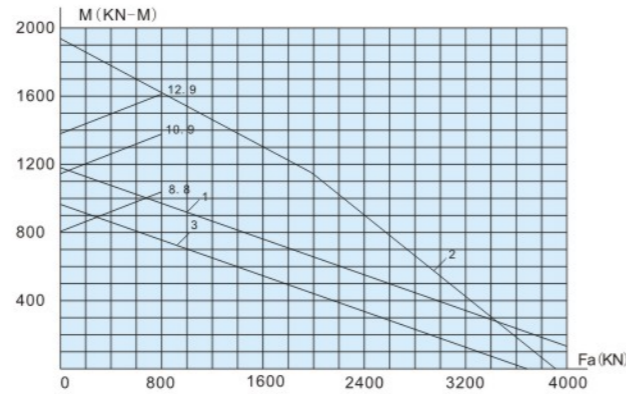

Fig. 1-120 011.45.1250.12

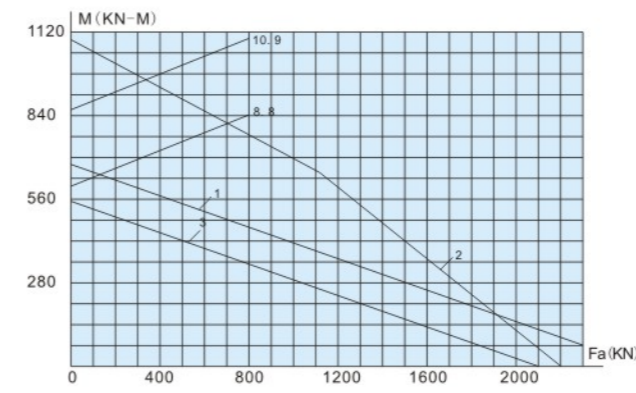

Fig. 1-121 1787/1155

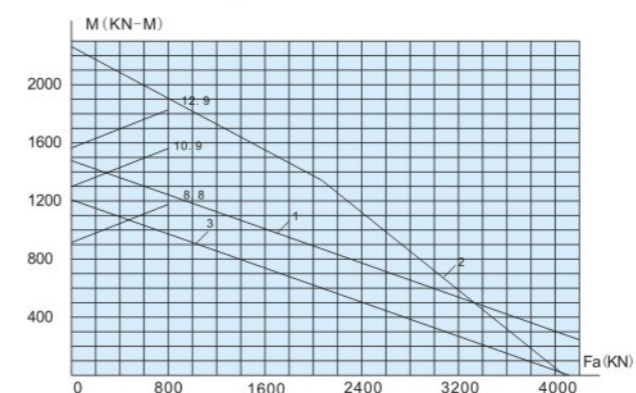

Fig. 1-123 011.45.1400.12

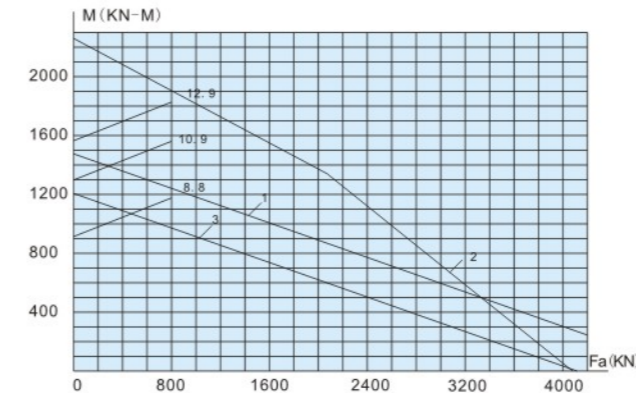

Fig. 1-125 011.45.1400.12K1

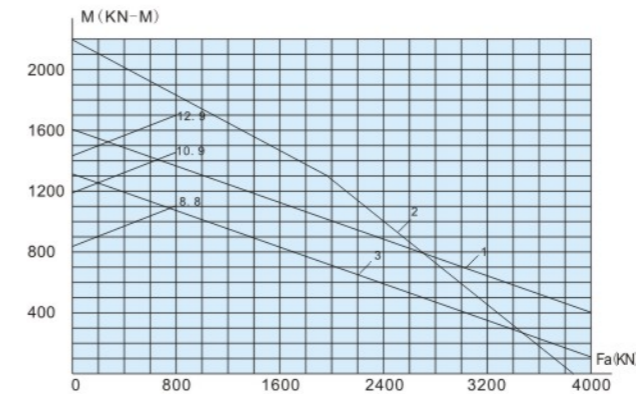

Fig. 1-127 011.35.1435.12

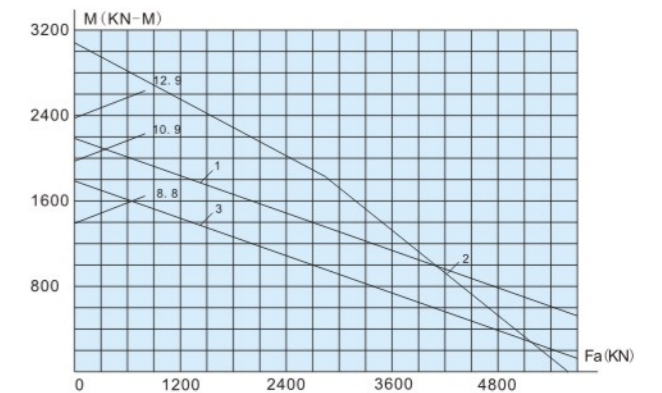

Fig. 1-122 011.50.1390.03

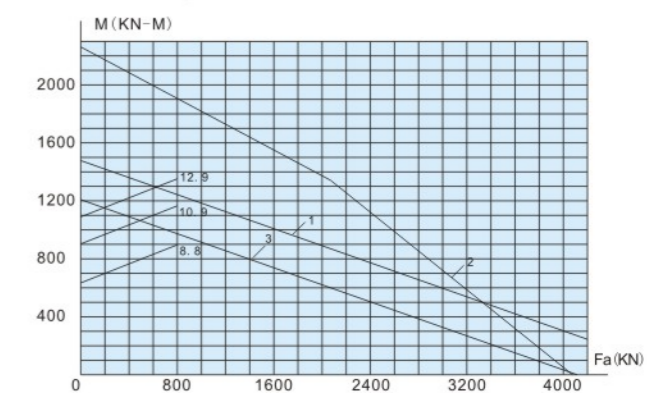

Fig. 1-124 011.45.1400.12K

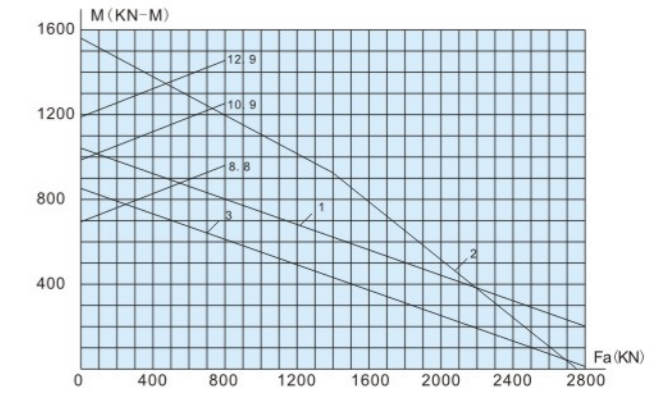

Fig. 1-126 D1787/1260

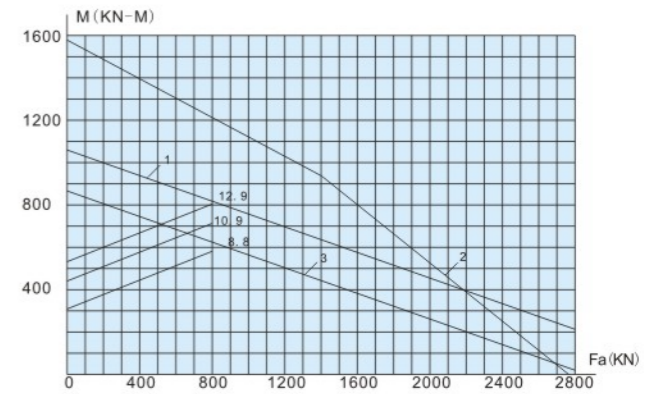

Fig. 1-128 1787/1330G2



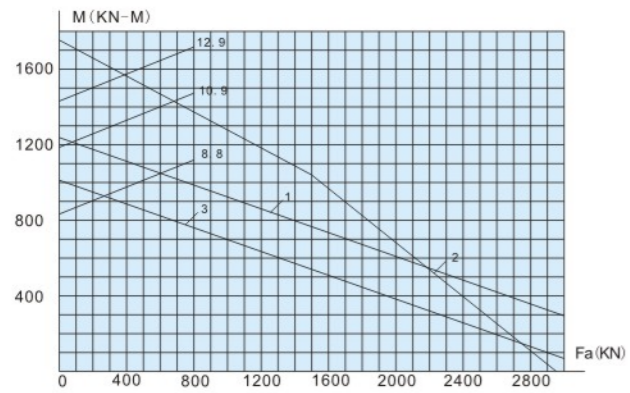

Fig. 1-129 011.30.1500.04

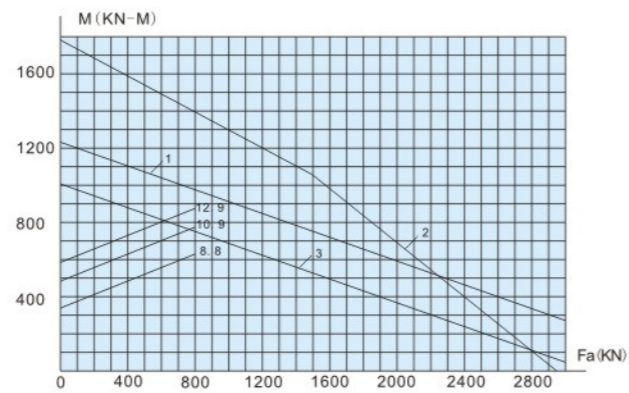

Fig. 1-130 E1788/1410G2K1

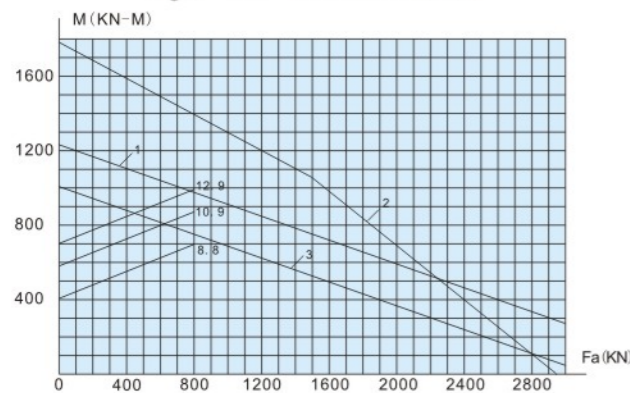

Fig. 1-131 1788/1410

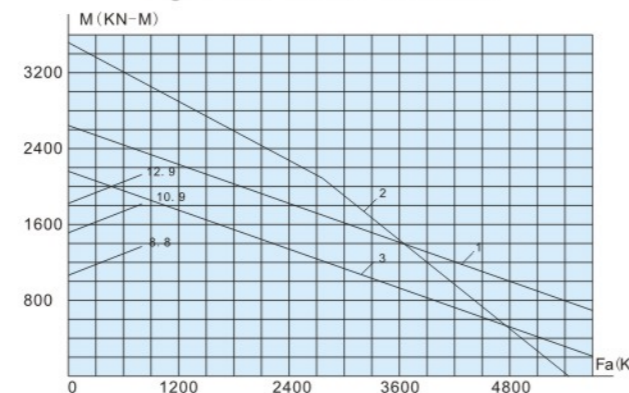

Fig. 1-132 1787/1460

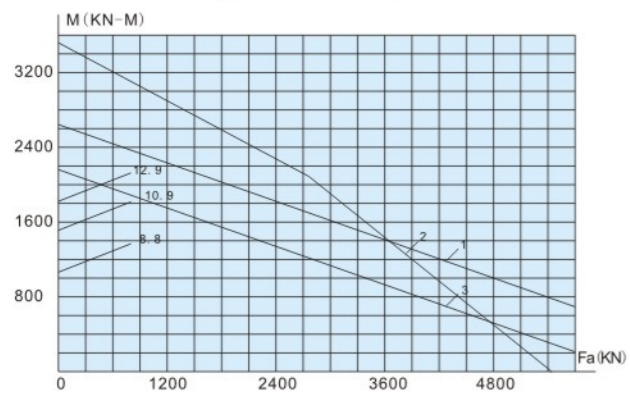

Fig. 1-133 1787/1460K

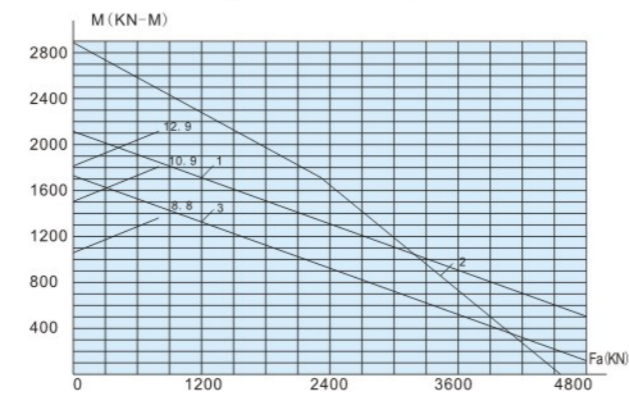

Fig. 1-134 011.45.1600.12K

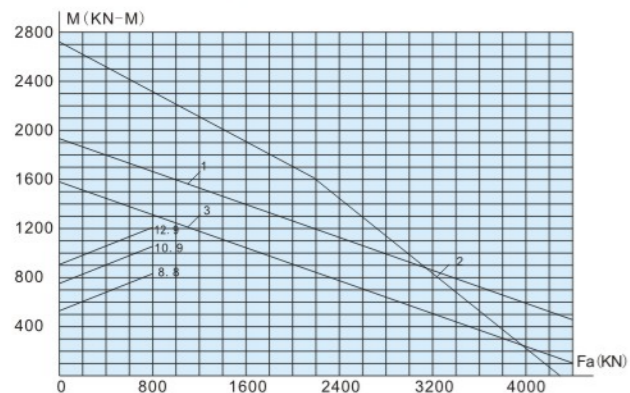

Fig. 1-135 012.45.1600.12K

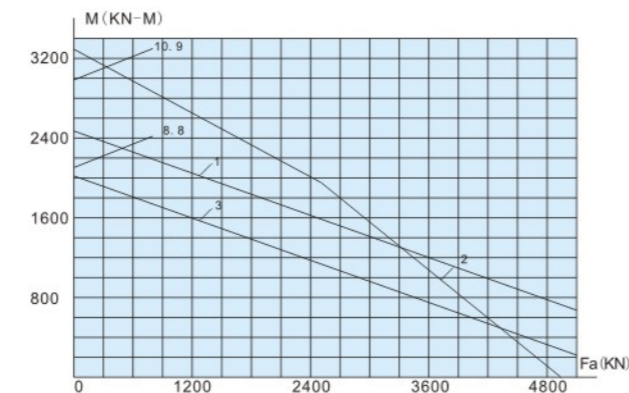

Fig. 1-136 011.50.1682.03/P5

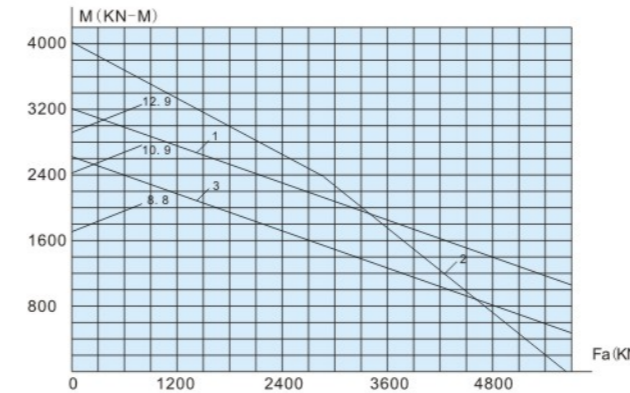

Fig. 1-137 012.50.1800.03

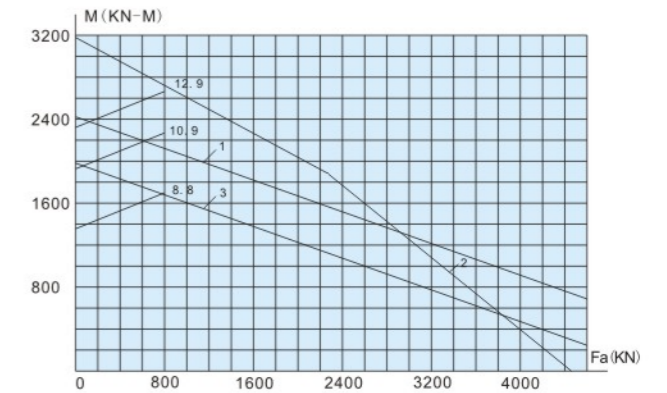

Fig. 1-138 012.45.1800.03

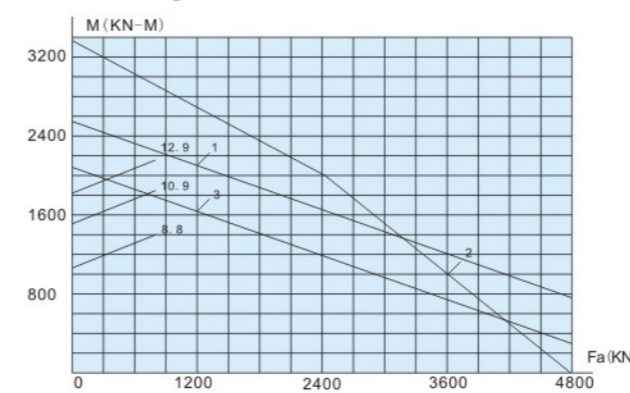

Fig. 1-139 1787/1628G2K1

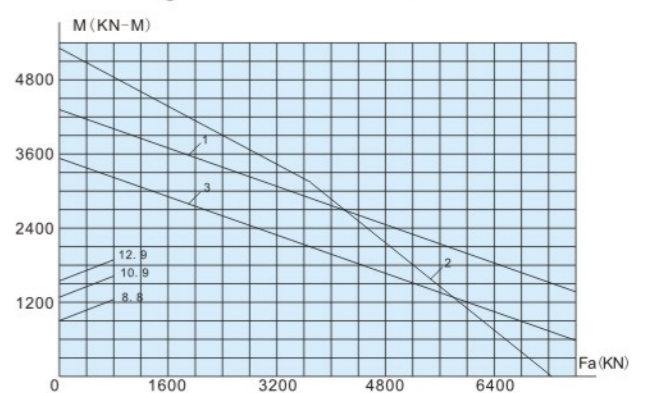

Fig. 1-140 1787/1640G

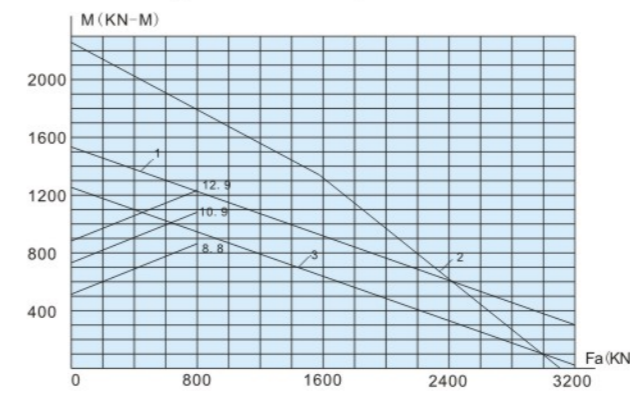

Fig. 1-141 1787/1700

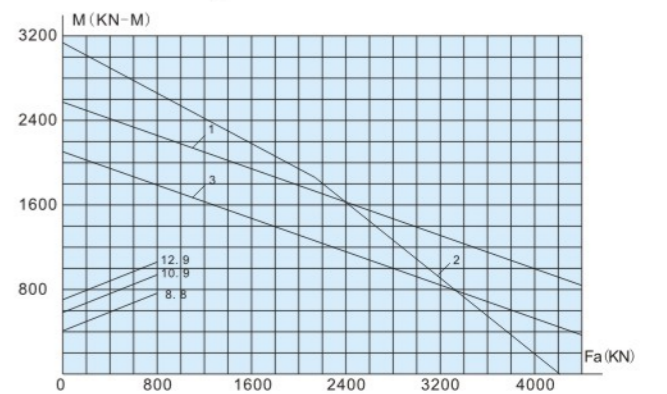

Fig. 1-142 1789/1700GM

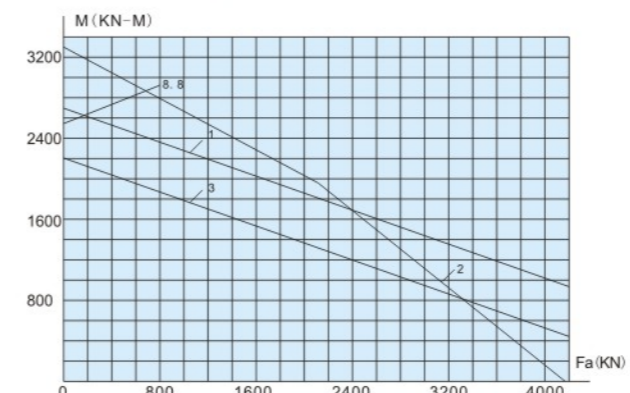

Fig. 1-143 011.40.2000.12

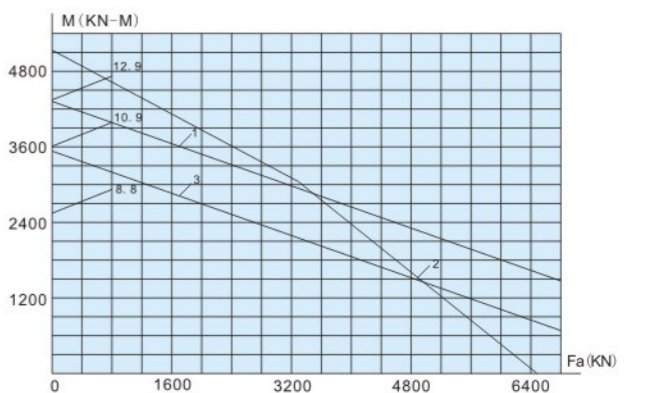

Fig. 1-144 011.60.2000.12



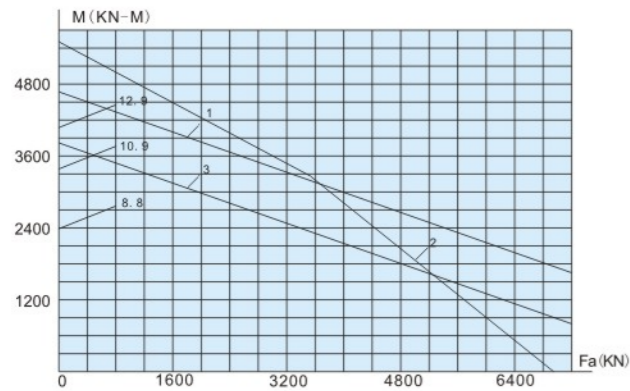

Fig. 1-145 011.60.2000.12K

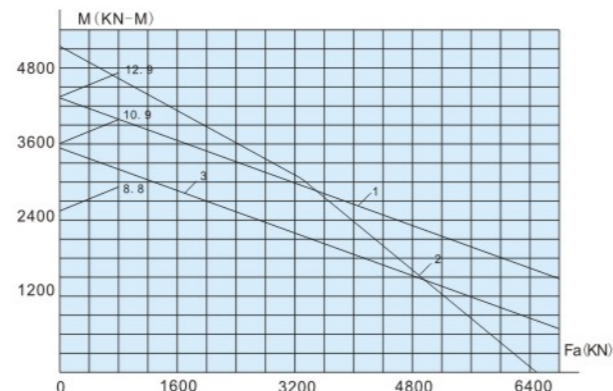

Fig. 1-146 012.60.2000.12

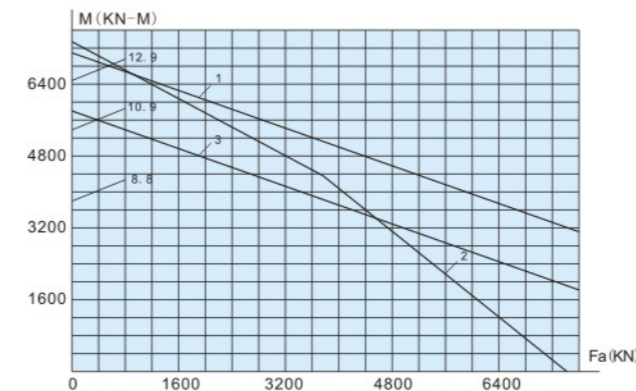

Fig. 1-153 011.60.2500.12

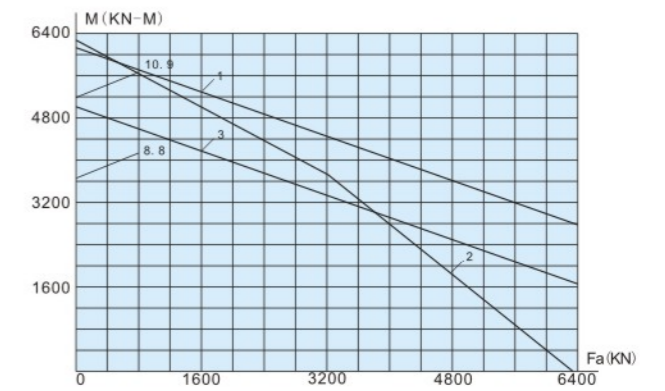

Fig. 1-154 011.50.2500.12

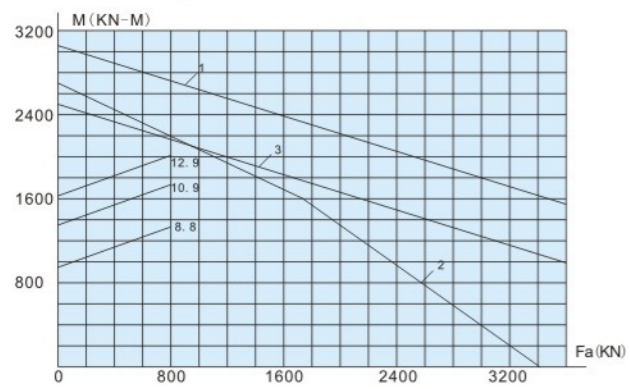

Fig. 1-147 1788/1877

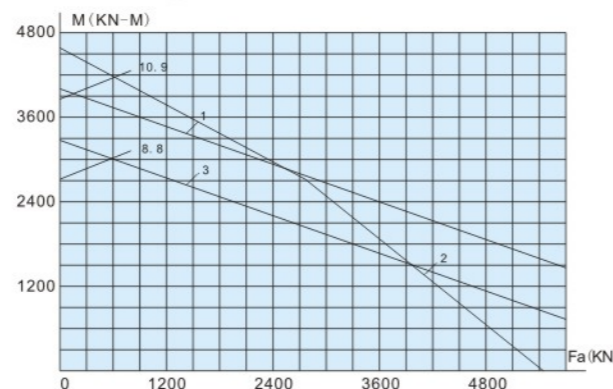

Fig. 1-148 1787/1948

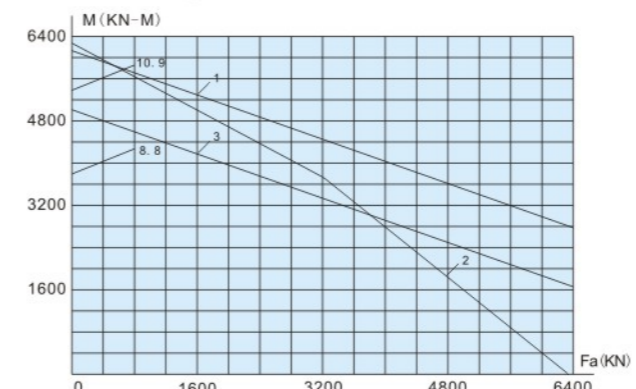

Fig. 1-155 012.50.2500.03

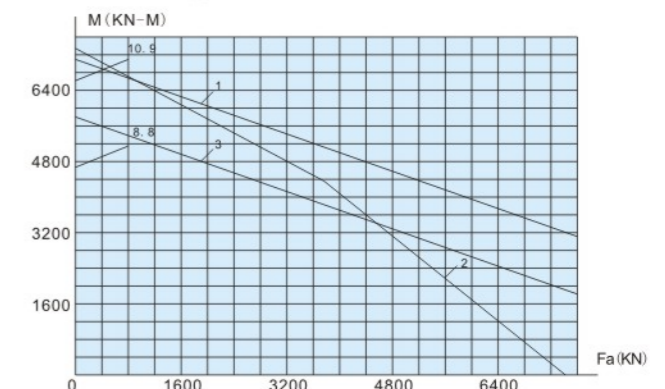

Fig. 1-156 012.60.2500.12

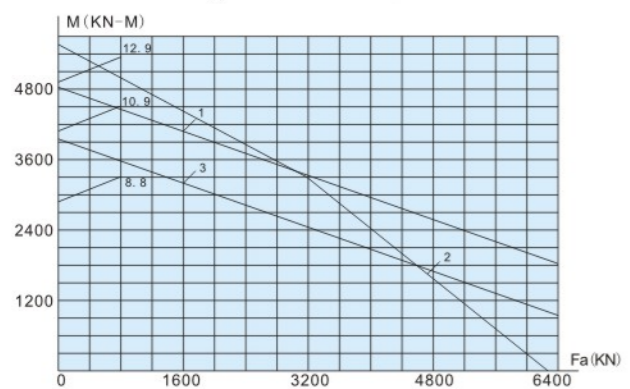

Fig. 1-149 011.60.2240.03K/P5

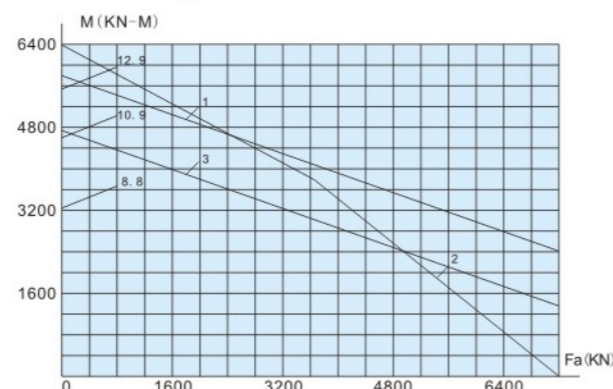

Fig. 1-150 012.60.2240.03K

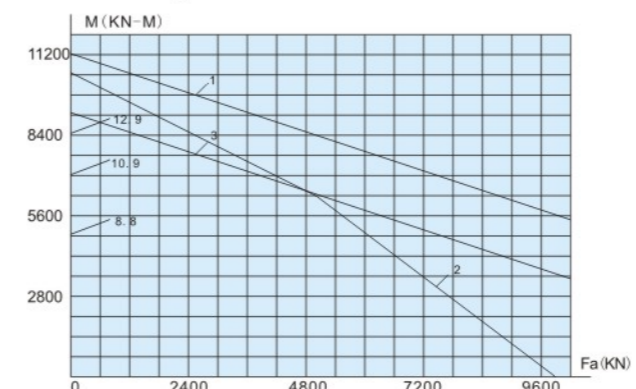

Fig. 1-157 012.70.2700.03

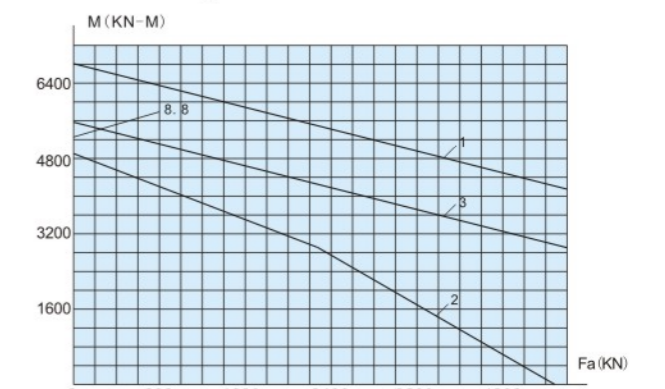

Fig. 1-158 1788/2617

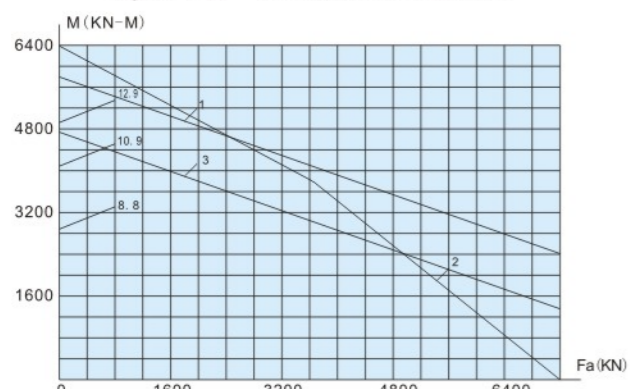

Fig. 1-151 012.60.2240.12

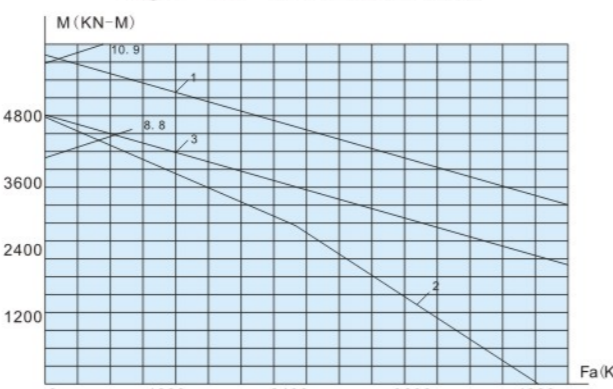

Fig. 1-152 011.40.2500.12

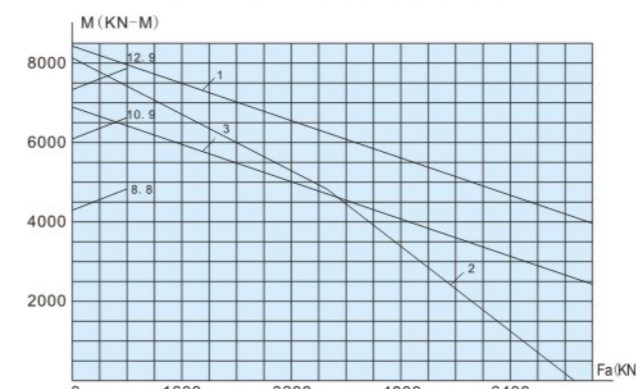

Fig. 1-159 012.60.2800.03

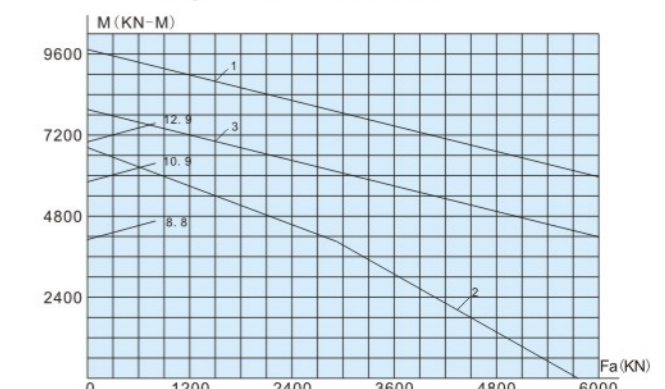

Fig. 1-160 1787/2635G2



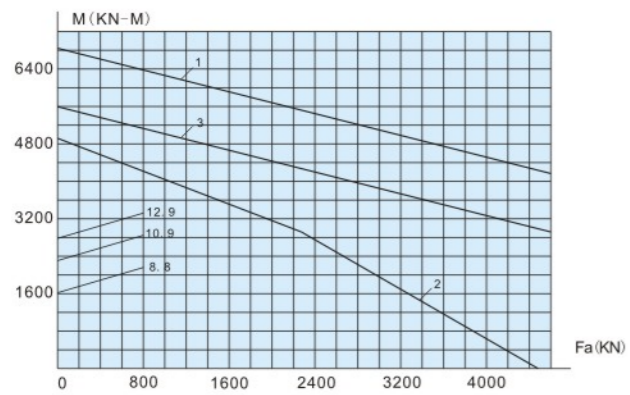

Fig. 1-161 1787/2650G2

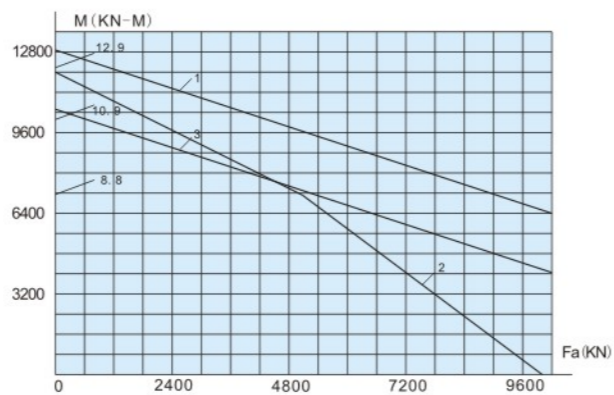

Fig. 1-162 012.75.3030.03

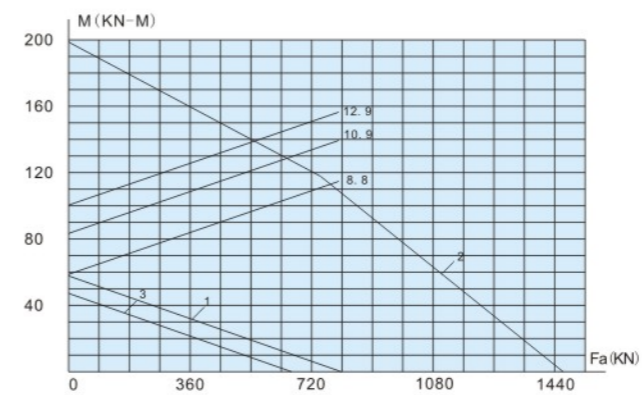

Fig. 1-170 LY-Q020

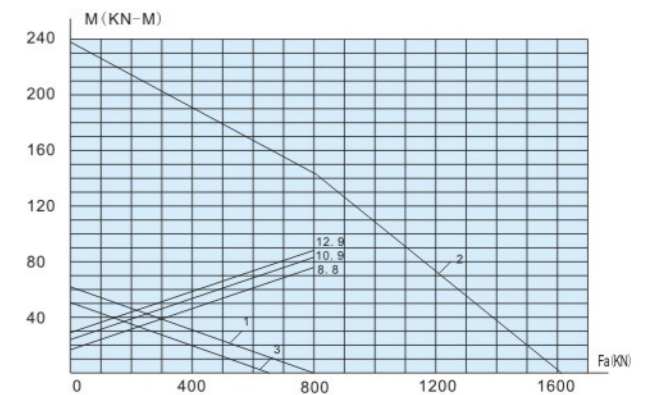

Fig. 1-171 116752

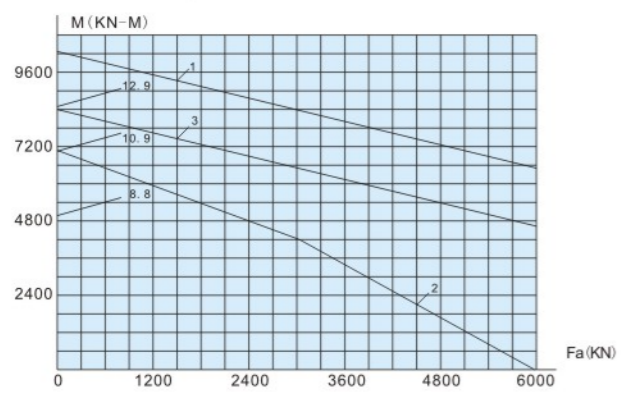

Fig. 1-163 1787/2833

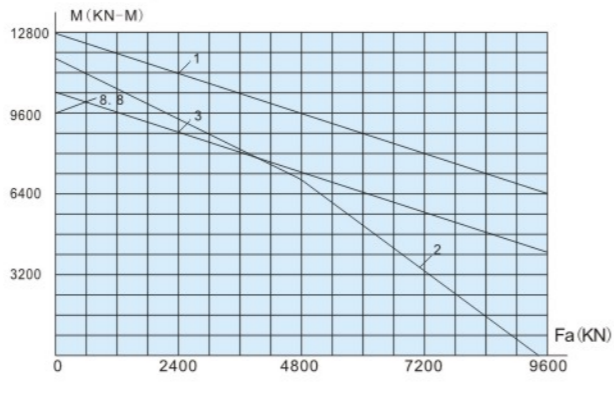

Fig. 1-164/图1-165 011.75.3150.03

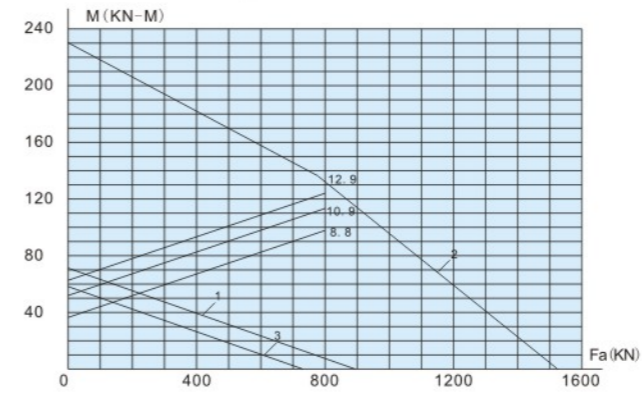

Fig. 1-172 LY-Q007

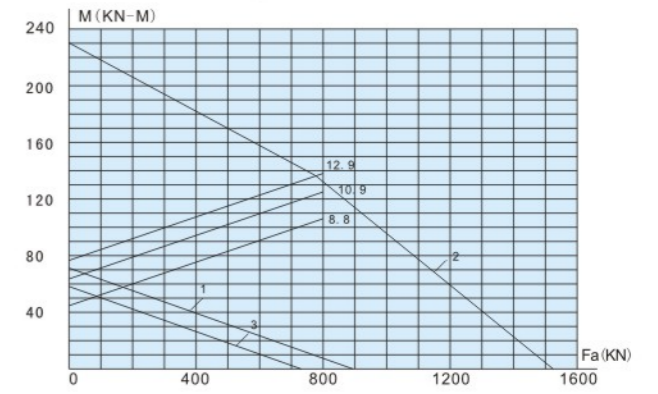

Fig. 1-173 LY-Q007K

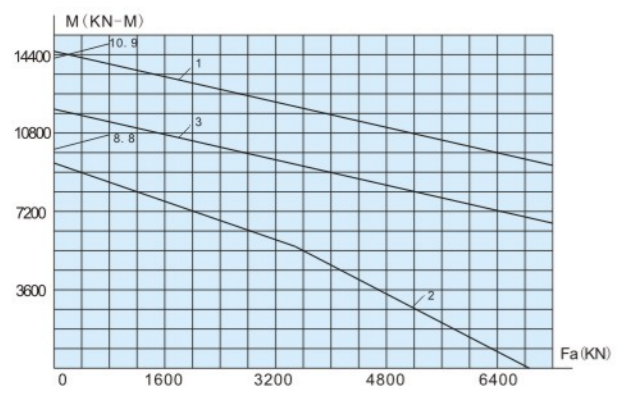

Fig. 1-166 1787/3250

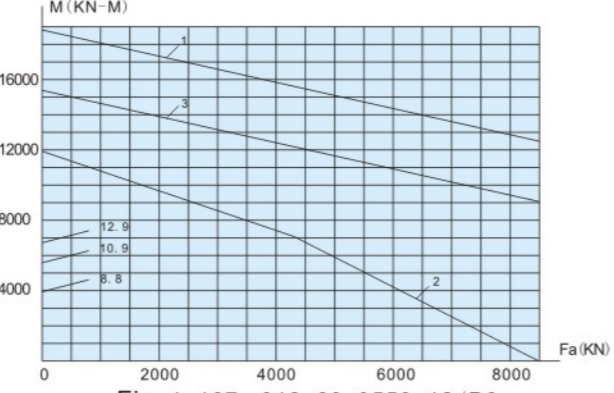

Fig. 1-167 012.60.3550.12/P6

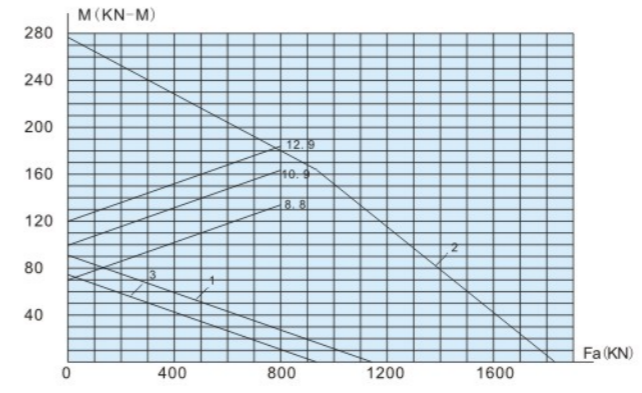

Fig. 1-174 787/285G2

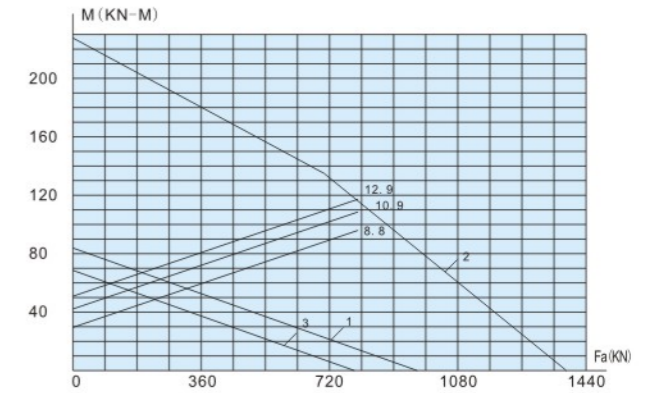

Fig. 1-175 787/304RG2

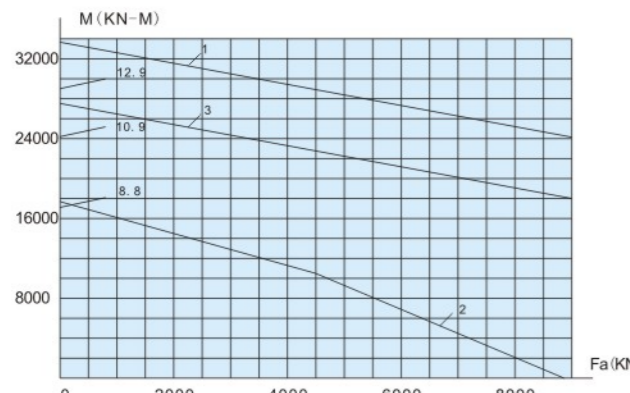

Fig. 1-168 1787/4810

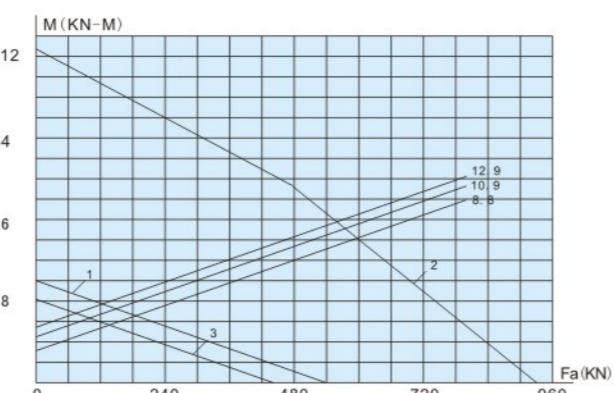

Fig. 1-169 010.20.310.03

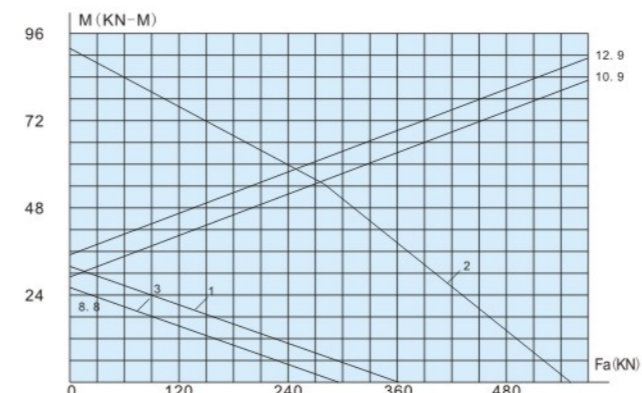

Fig. 1-176 78972

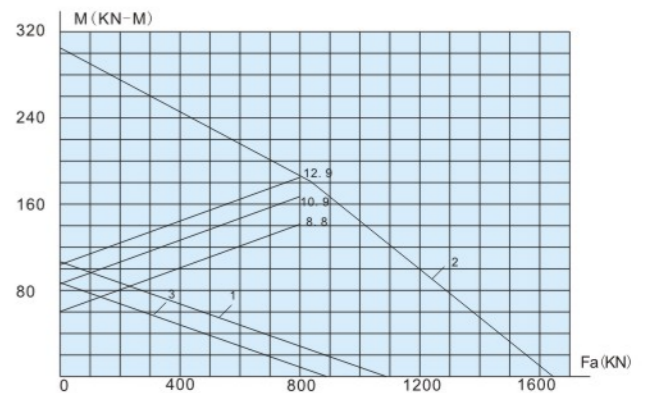

Fig. 1-177 010.25.467.03



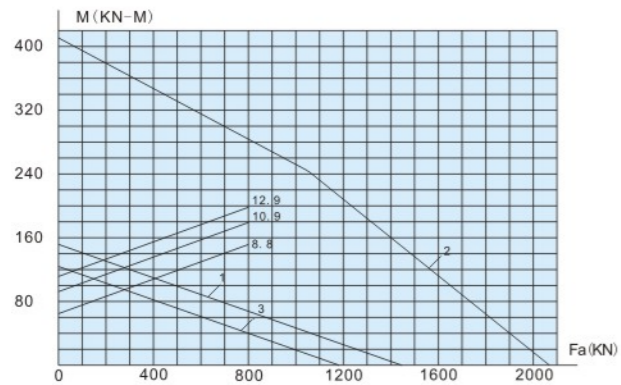

Fig. 1-178 010.30.500.12

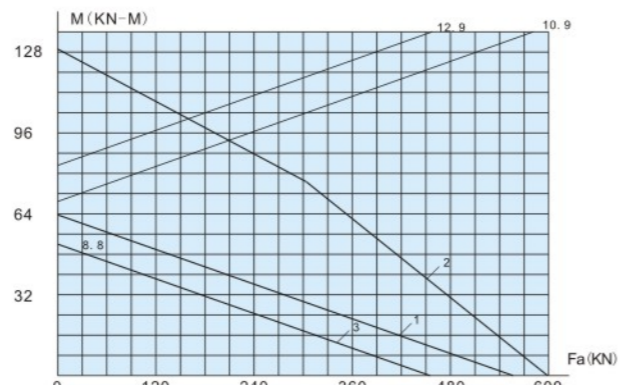

Fig. 1-179 787/434G2

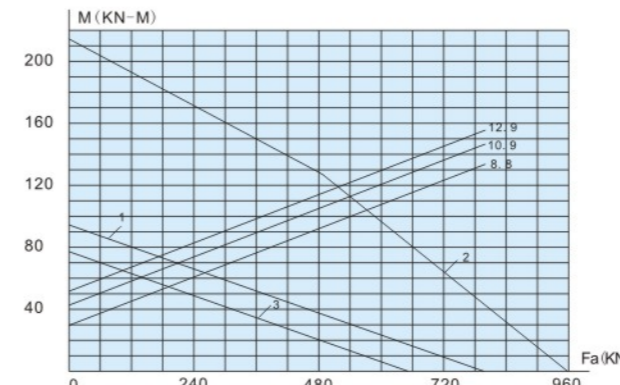

Fig. 1-186 78794G2

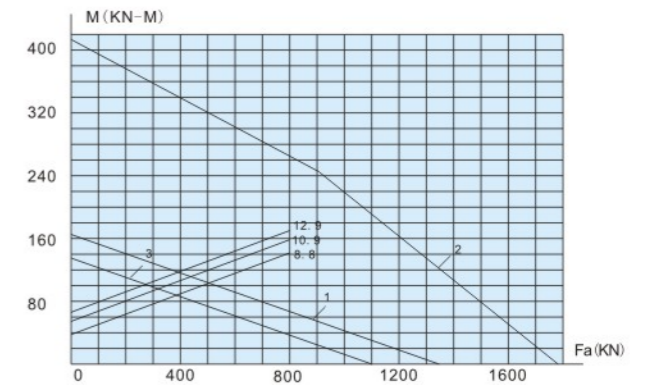

Fig. 1-187 010.25.585.03/P5

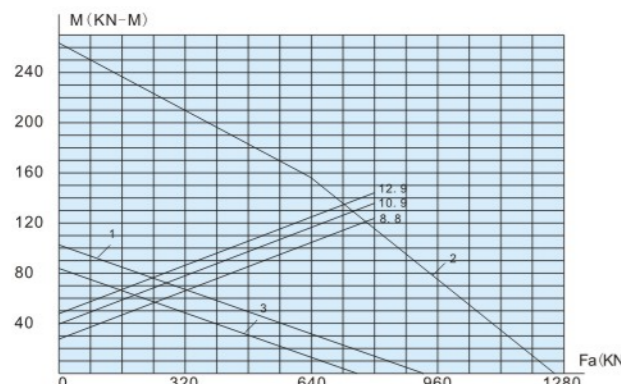

Fig. 1-180 D78790

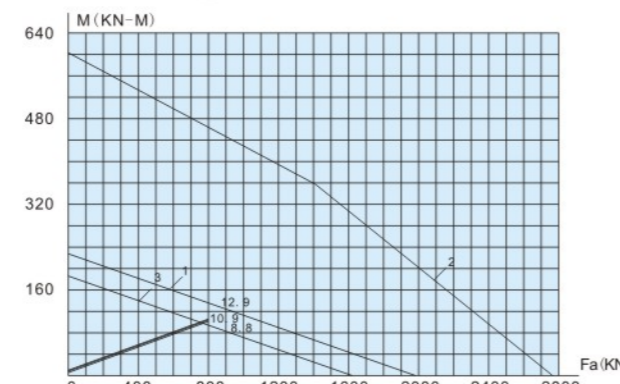

Fig. 1-181 78790G2

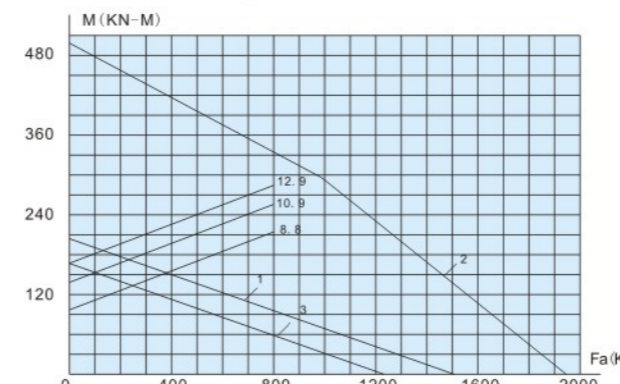

Fig. 1-188 010.28.646.03

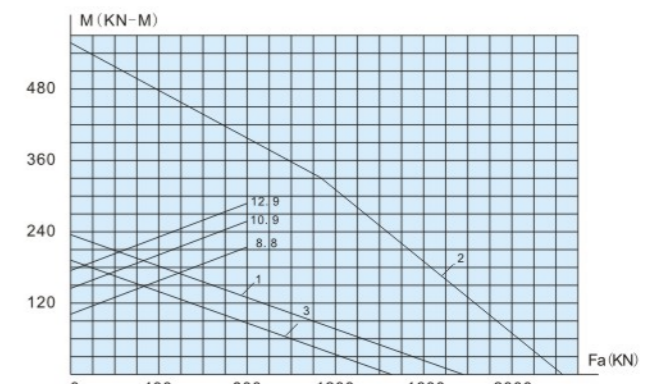

Fig. 1-189 010.30.630.12

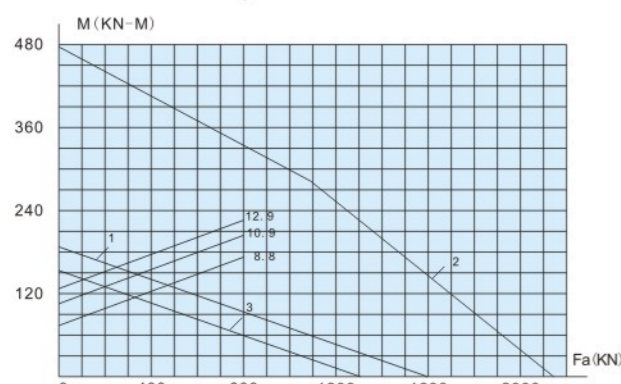

Fig. 1-182 010.30.560.12

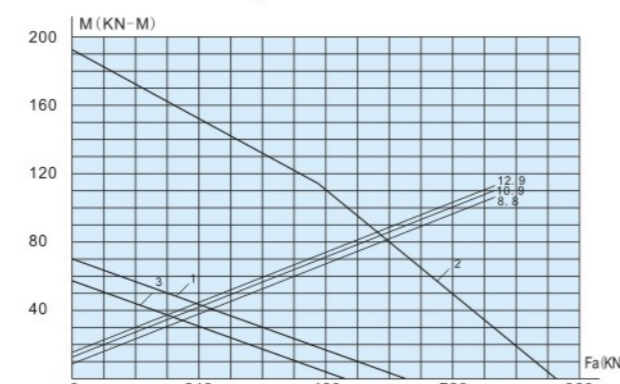

Fig. 1-183 176792

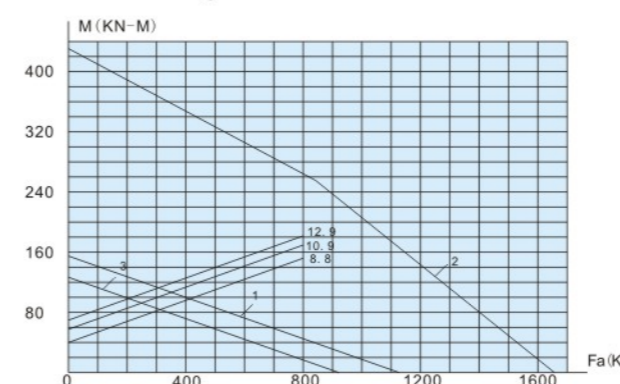

Fig. 1-190 1167/530

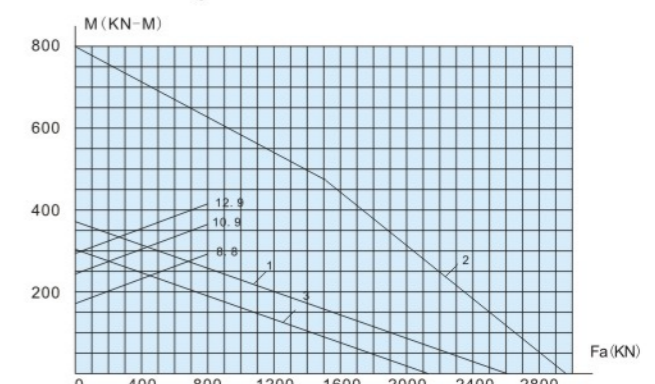

Fig. 1-191 787/560G2

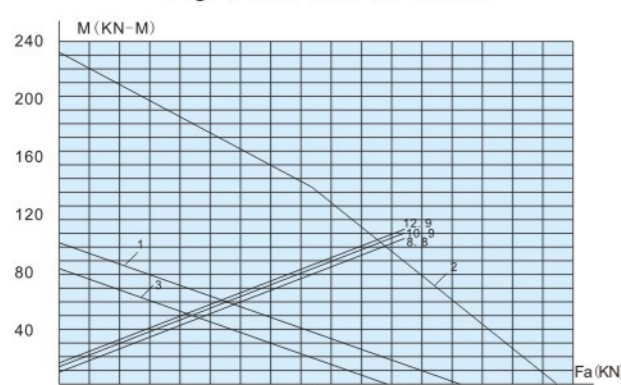

Fig. 1-184 D176792K3M

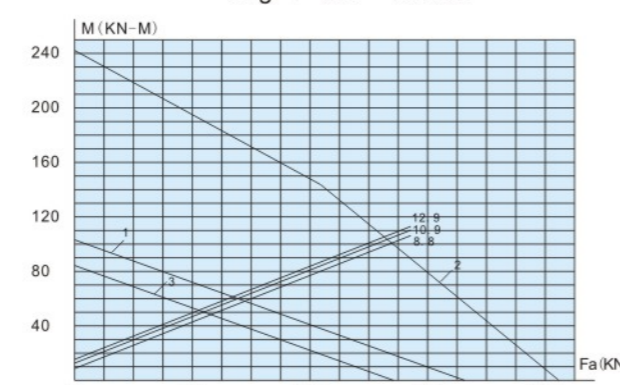

Fig. 1-185 D78892K

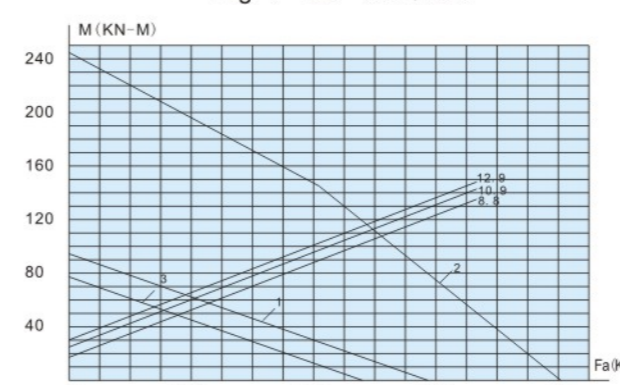

Fig. 1-192 1167/560

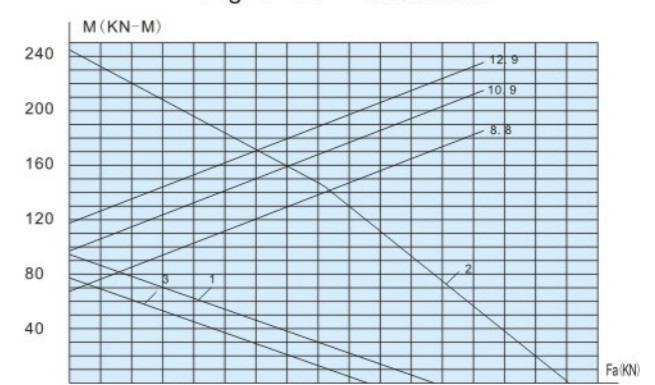

Fig. 1-193 1167/560K



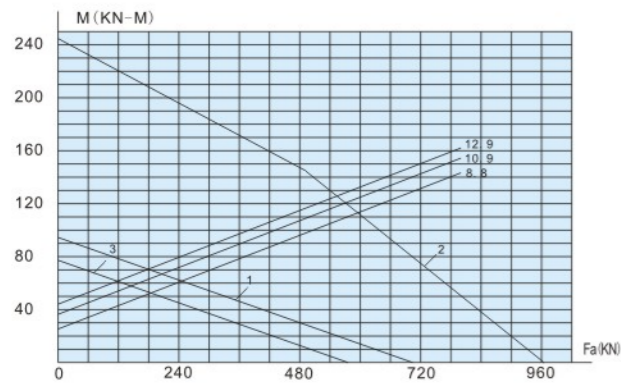

Fig. 1-194 1167/560M

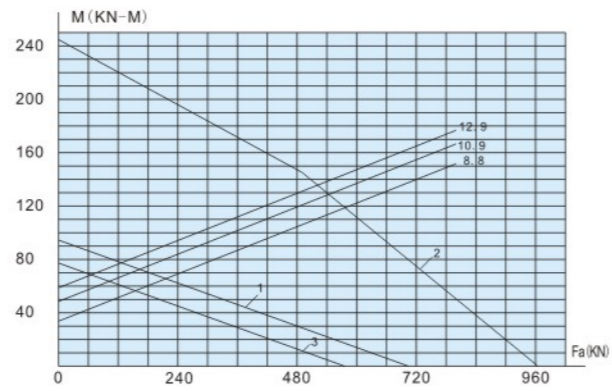

Fig. 1-195 1167/560MK1

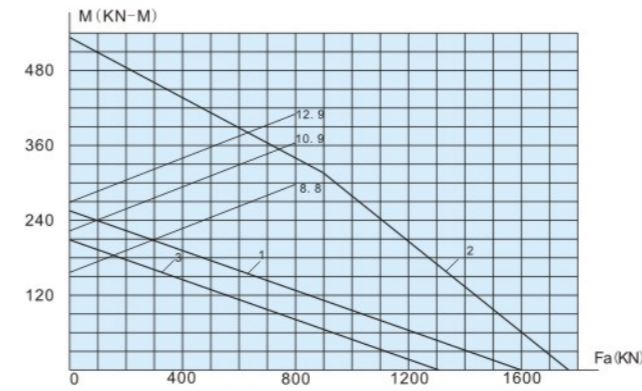

Fig. 1-202 787/675

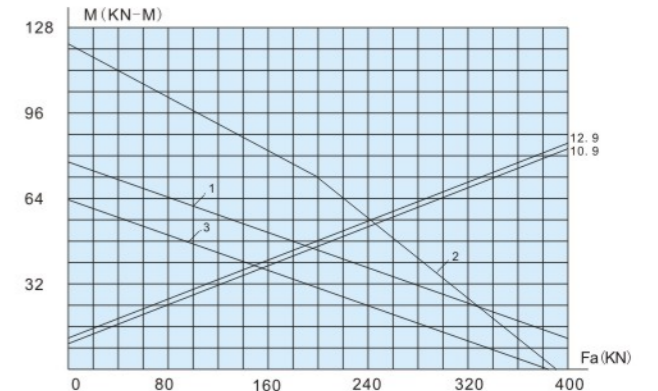

Fig. 1-203 D787/680

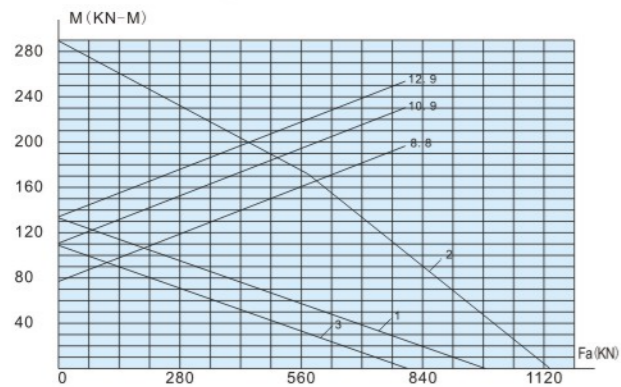

Fig. 1-196 010.20.644.11

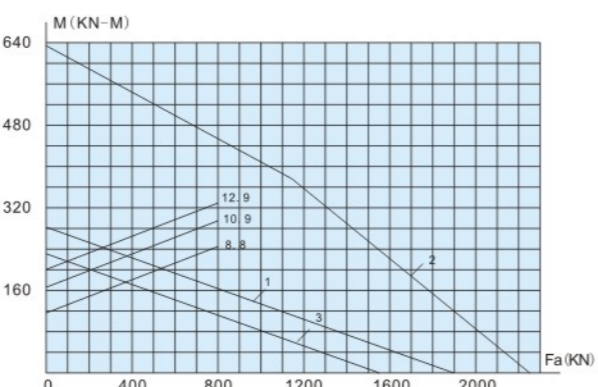

Fig. 1-197 010.30.710.12K

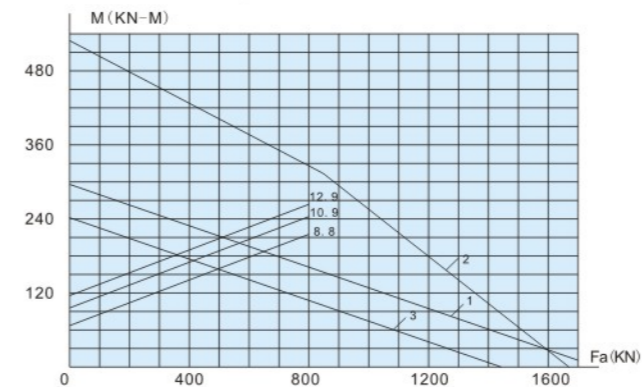

Fig. 1-204 1167/700

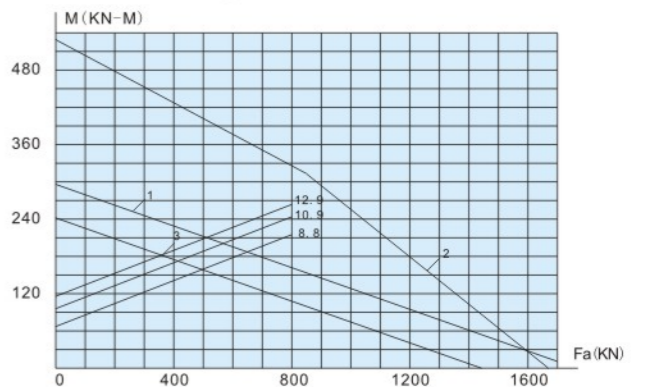

Fig. 1-205 1167/700K

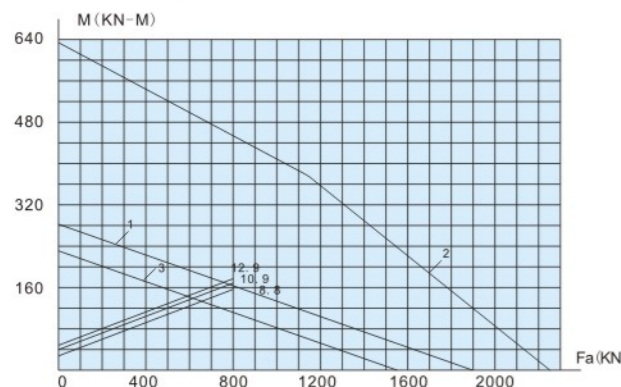

Fig. 1-198 010.30.710.12/P5

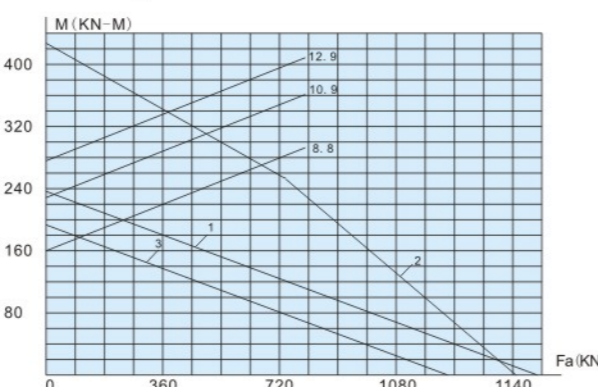

Fig. 1-199 010.20.745.03K

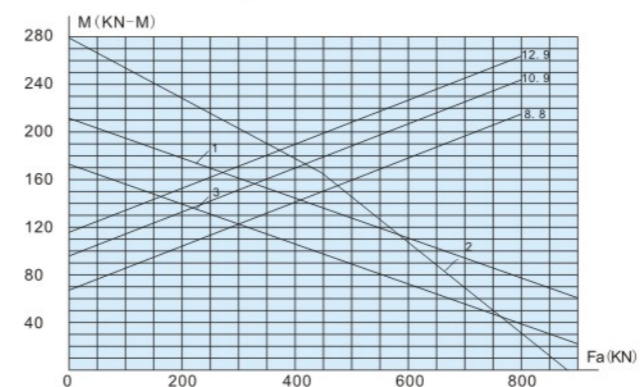

Fig. 1-206 787/700

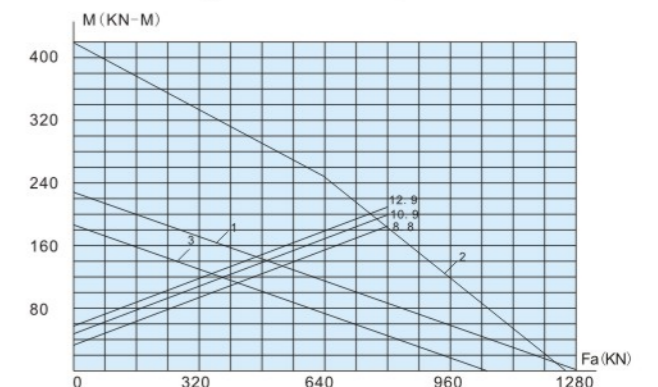

Fig. 1-207 787/734G2

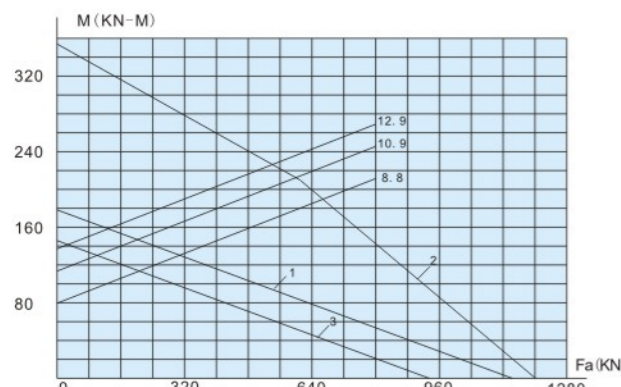

Fig. 1-200 010.20.745.03

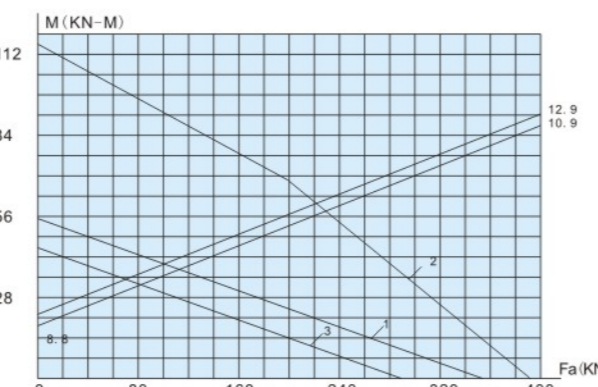

Fig. 1-201 787/670G2

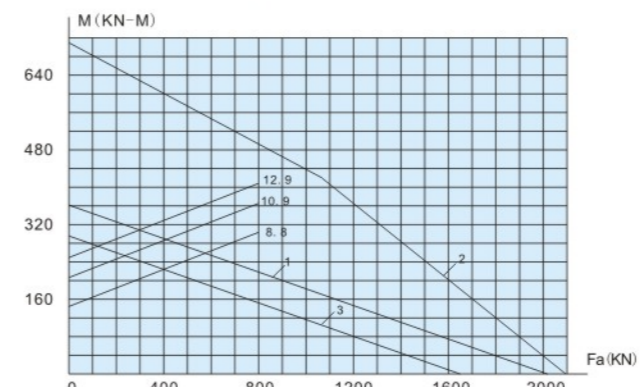

Fig. 1-208 E787/760G2

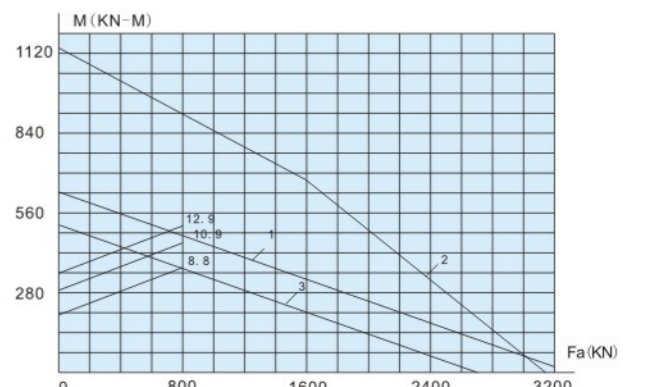

Fig. 1-209 787/762G2



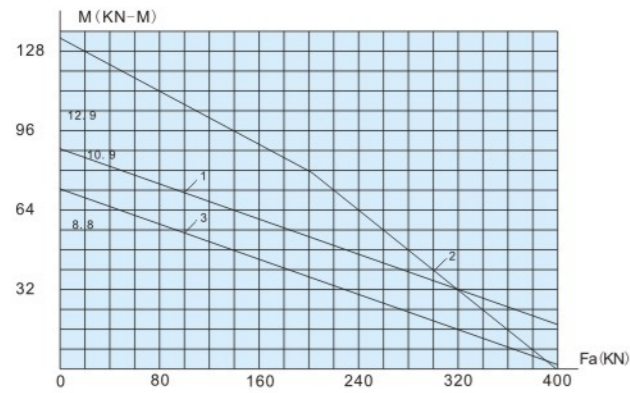

Fig. 1-210 QJ6/774YA

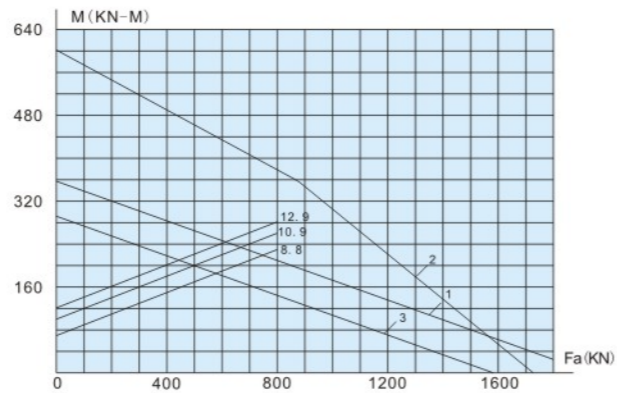

Fig. 1-211 3-640

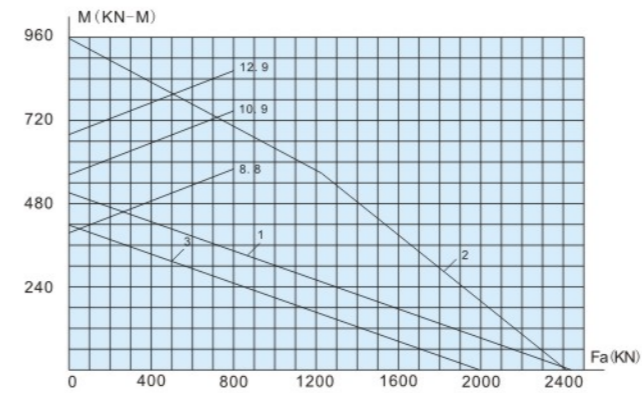

Fig. 1-218 010.30.1000.12K

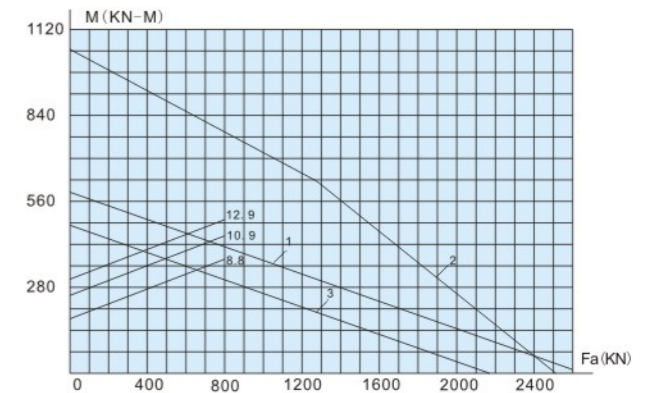

Fig. 1-219 010.30.1060.03

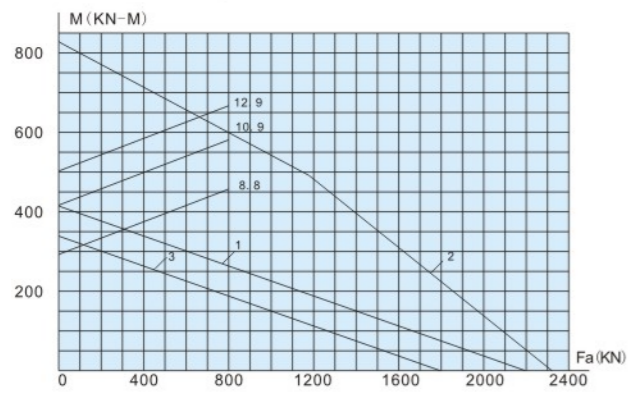

Fig. 1-212 010.30.900.12

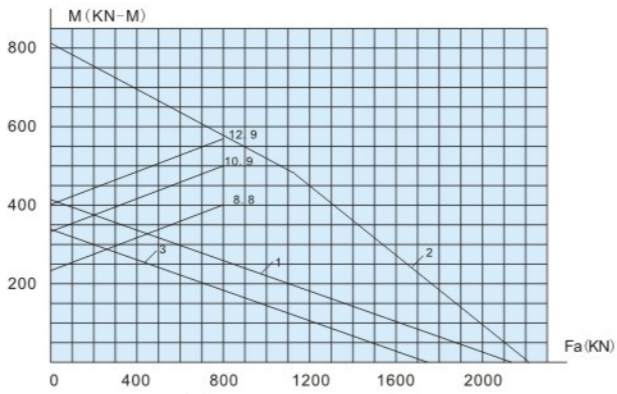

Fig. 1-213 787/800G

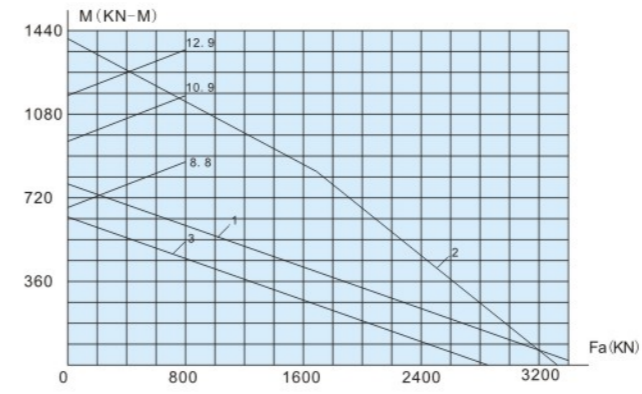

Fig. 1-220 787/932G2

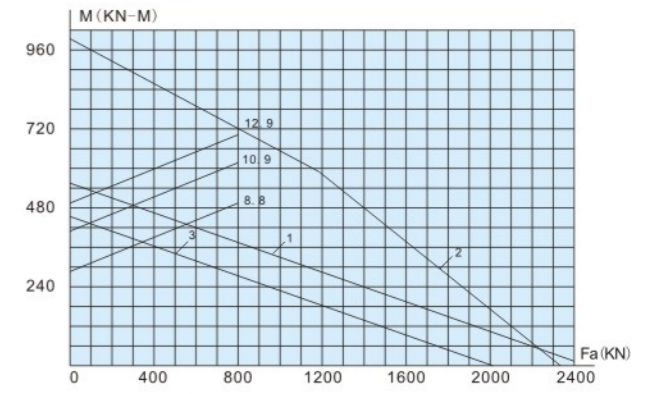

Fig. 1-221 787/960G2

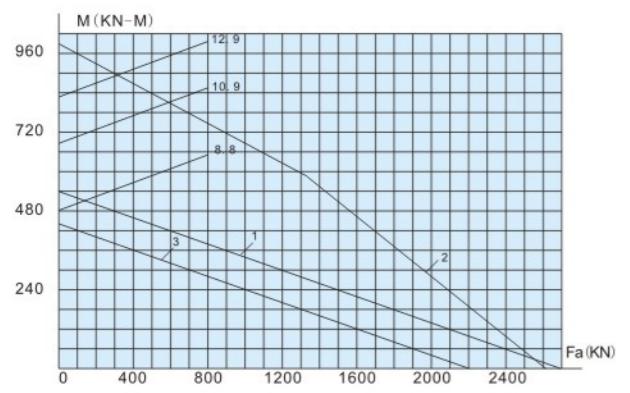

Fig. 1-214 010.30.955.11

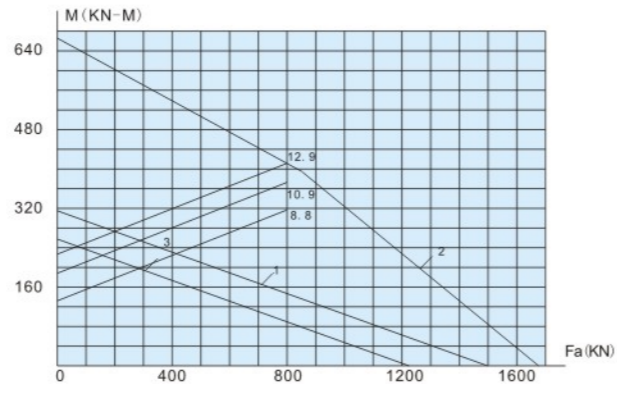

Fig. 1-215 71769/850Y

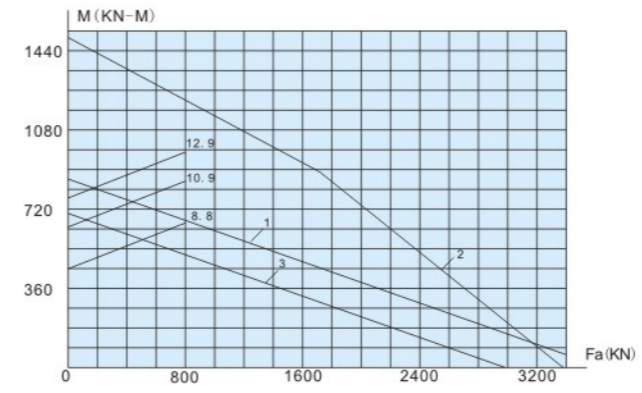

Fig. 1-222 010.40.1120.12

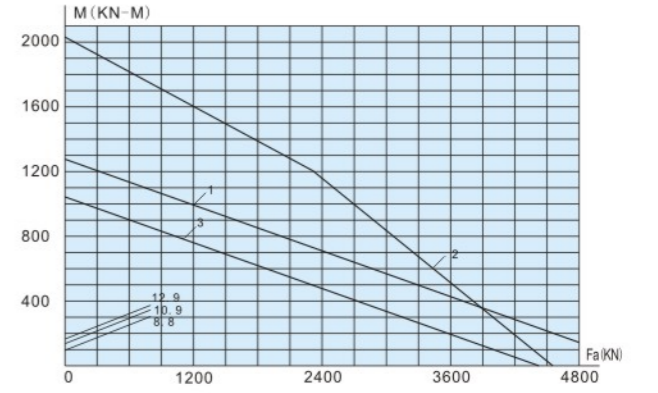

Fig. 1-223 787/1000G2

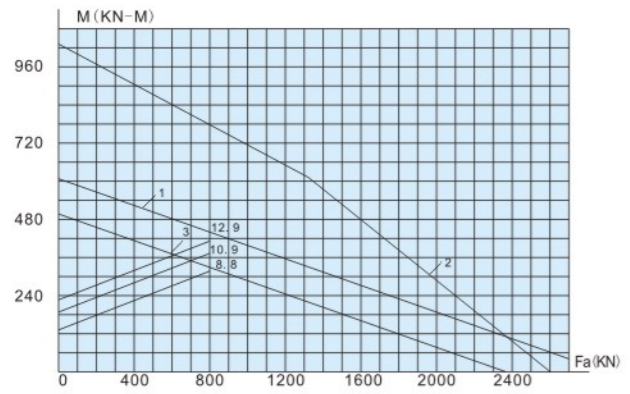

Fig. 1-216 71769/850G2K

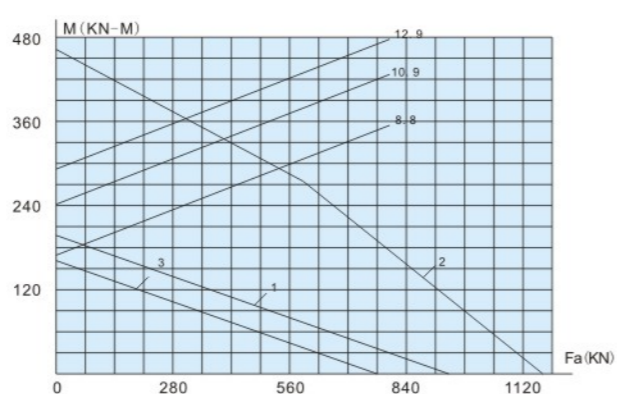

Fig. 1-217 D787/870G2

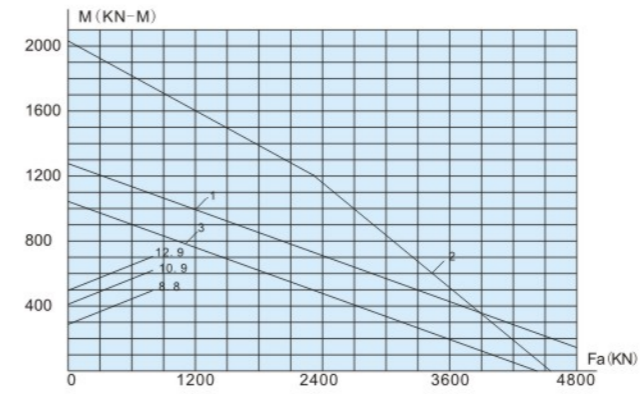

Fig. 1-224 787/1000G2K

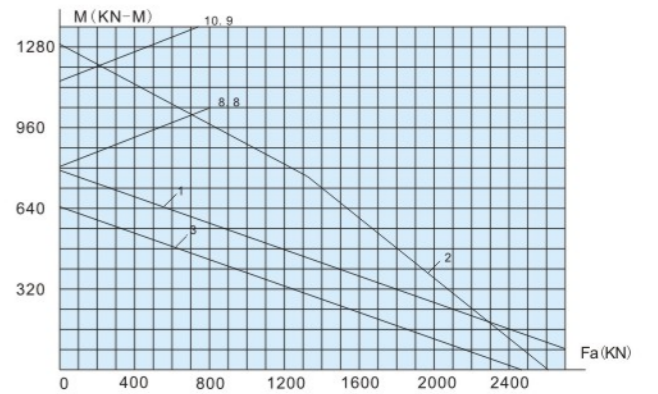

Fig. 1-225 010.30.1250.12



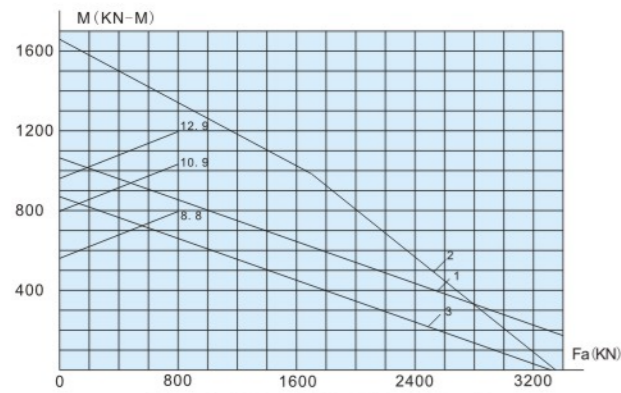

Fig. 1-226 010.35.1250.12

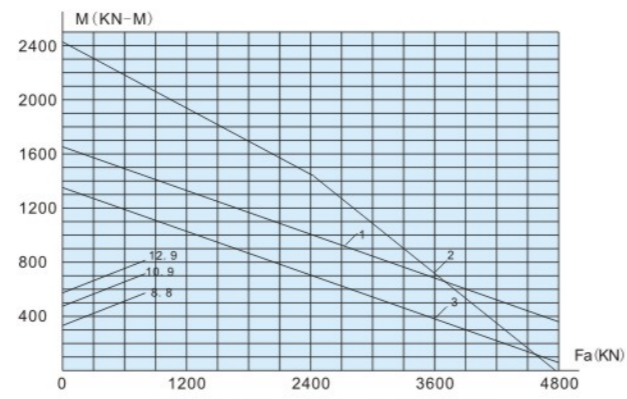

Fig. 1-227 010.45.1284.12

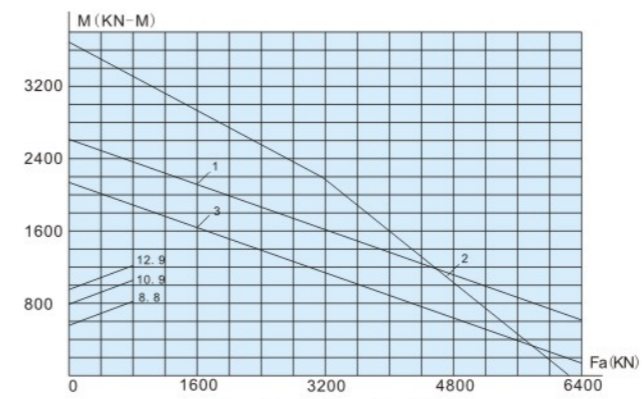

Fig. 1-234 787/1278

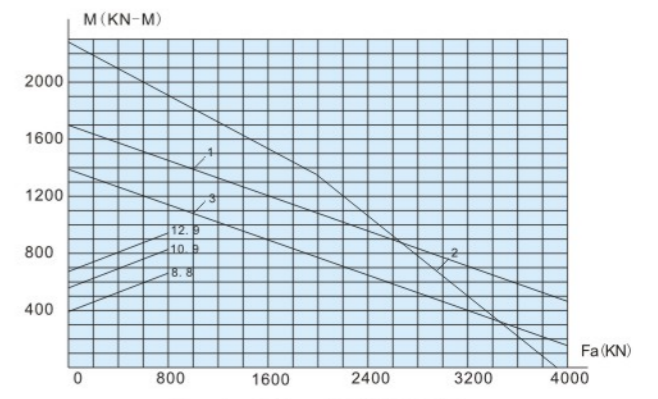

Fig. 1-235 787/1300G2

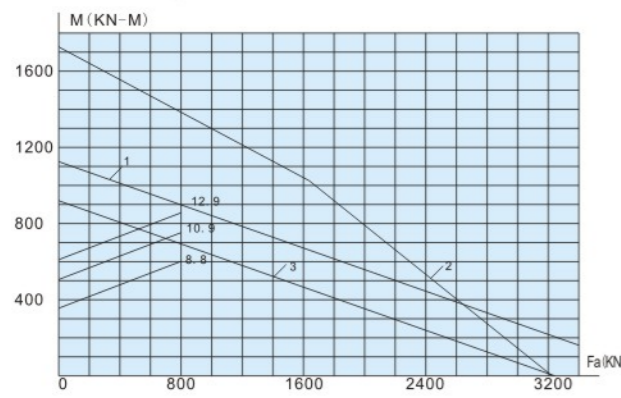

Fig. 1-228 010.35.1352.12

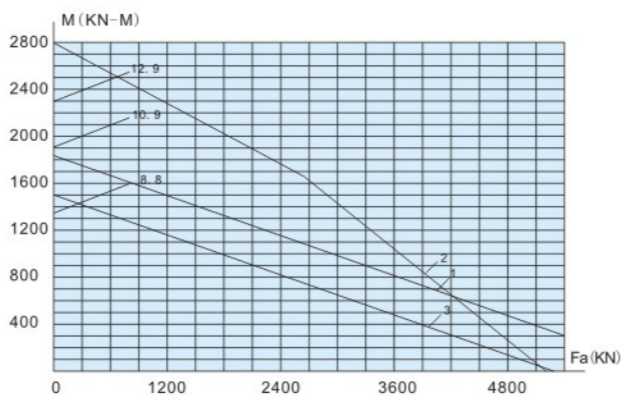

Fig. 1-229 787/1184

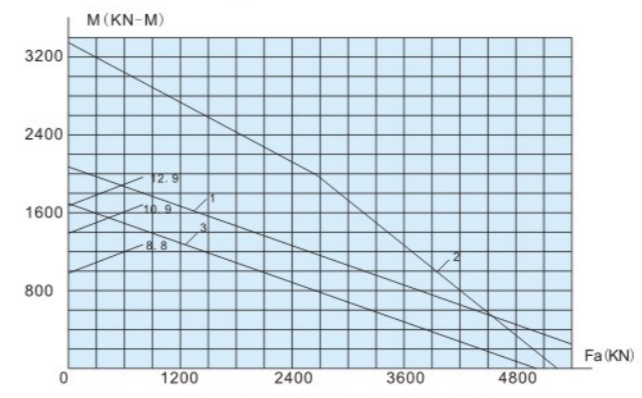

Fig. 1-236 71169/1400Y

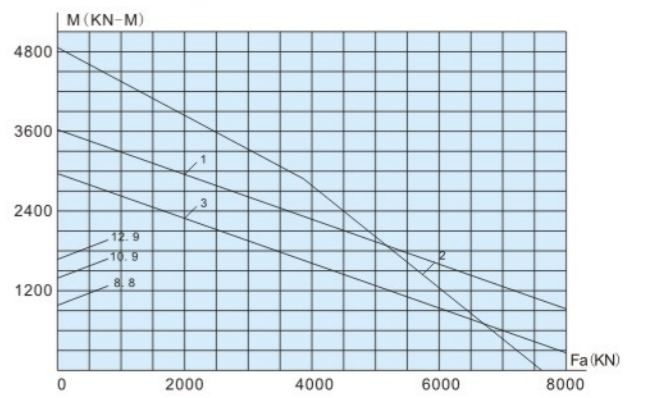

Fig. 1-237 71169/1400Y1

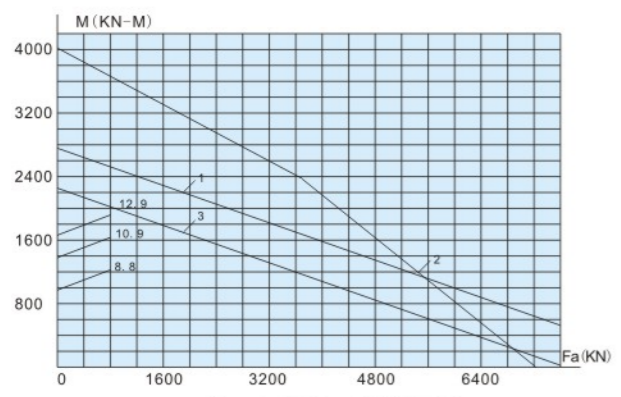

Fig. 1-230 787/1210

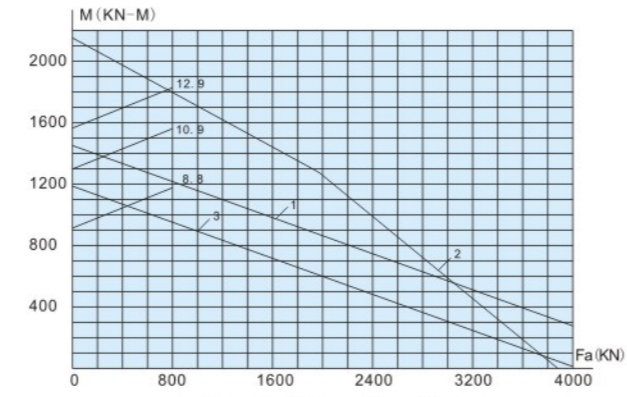

Fig. 1-231 787/1260

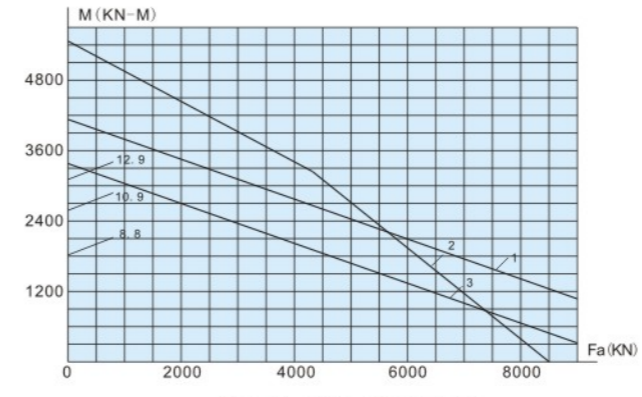

Fig. 1-238 787/1430

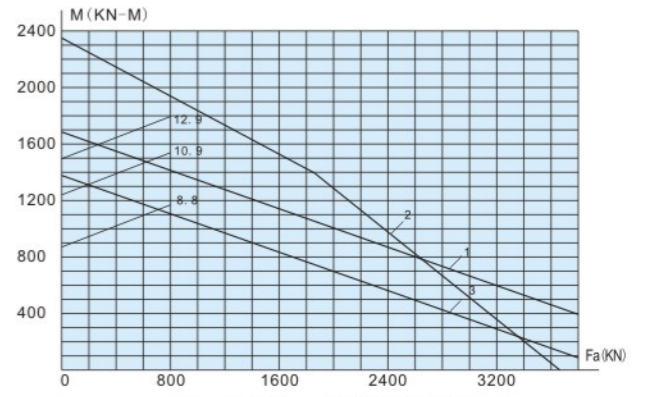

Fig. 1-239 787/1440G2

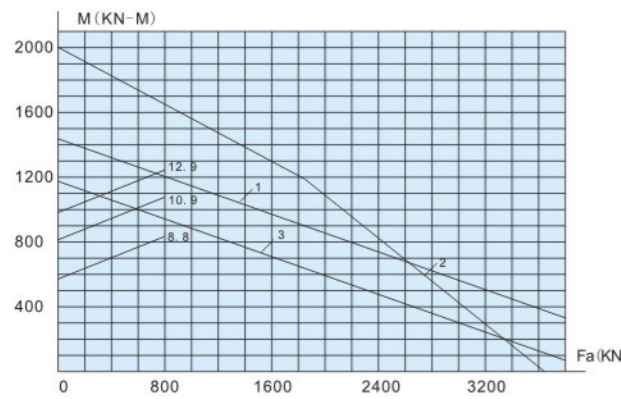

Fig. 1-232 789/1260G2

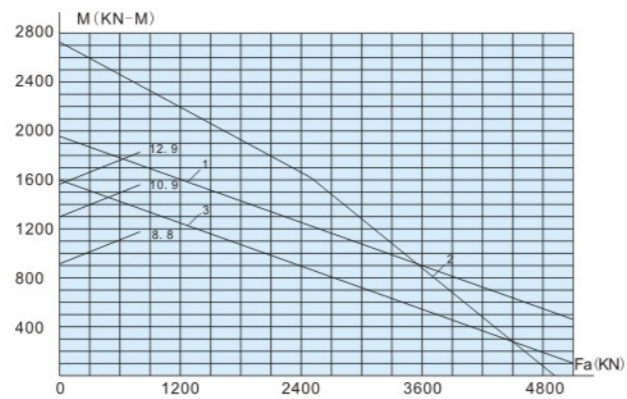

Fig. 1-233 010.45.1400.12K

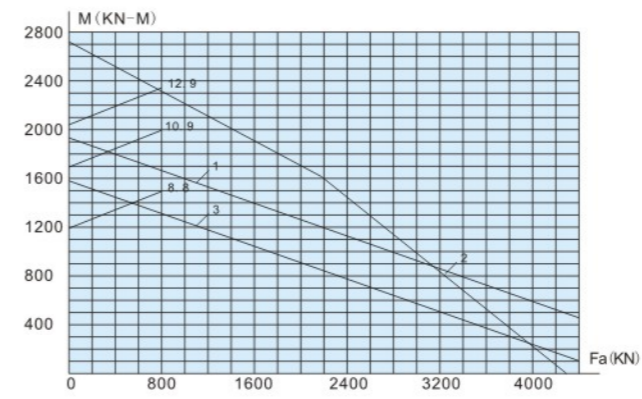

Fig. 1-240 010.45.1600.12K/P5

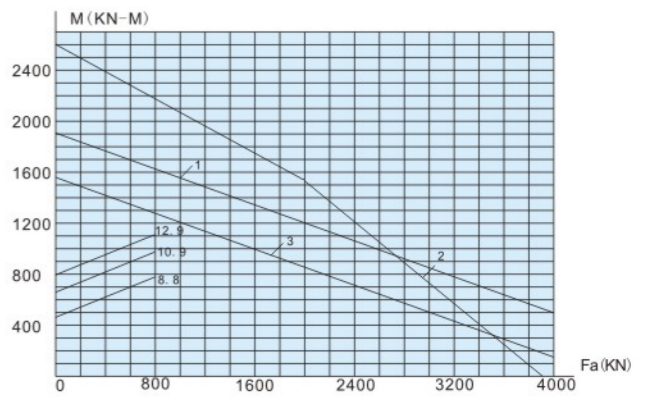

Fig. 1-241 787/1525G2



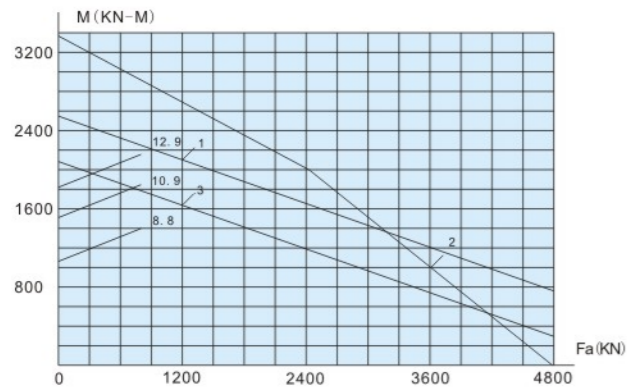

Fig. 1-242 787/1628G2

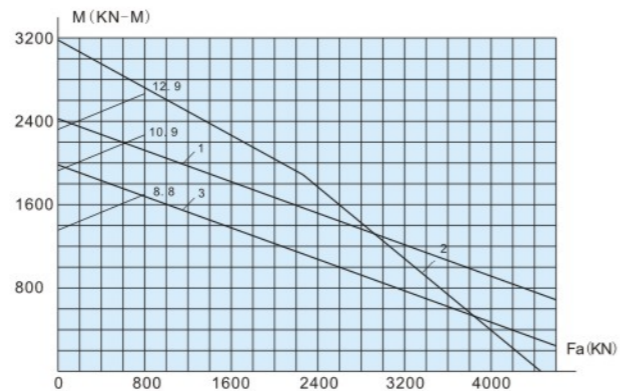

Fig. 1-243 010.45.1800.12

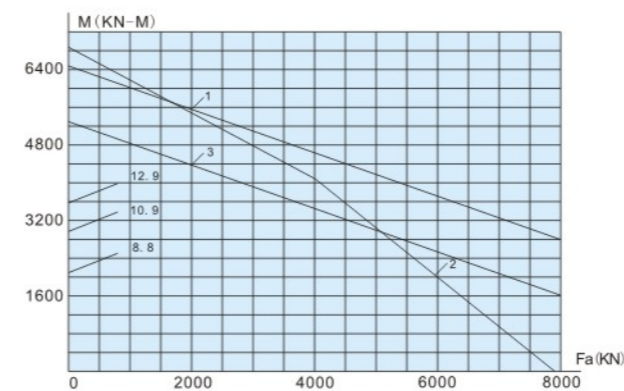

Fig. 1-250 787/2000G2

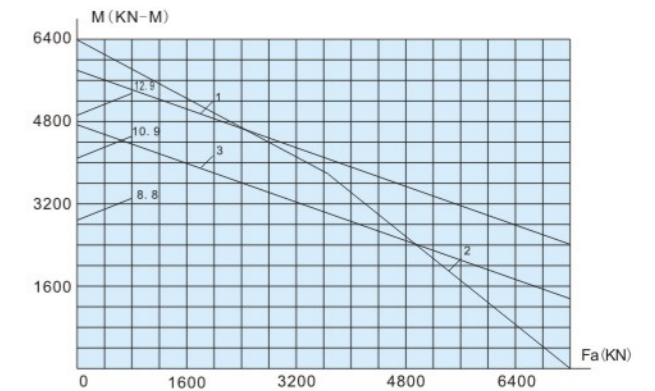

Fig. 1-251 010.60.2240.12

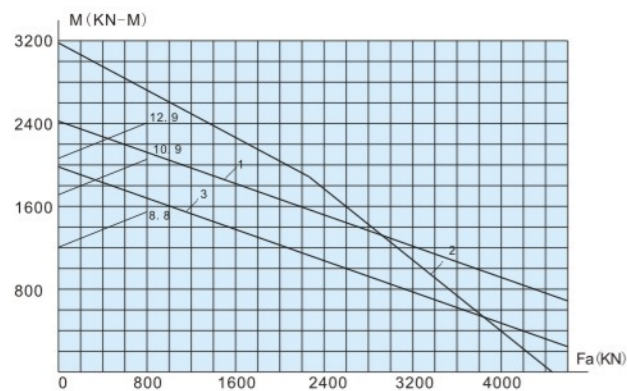

Fig. 1-244 010.45.1800.12K

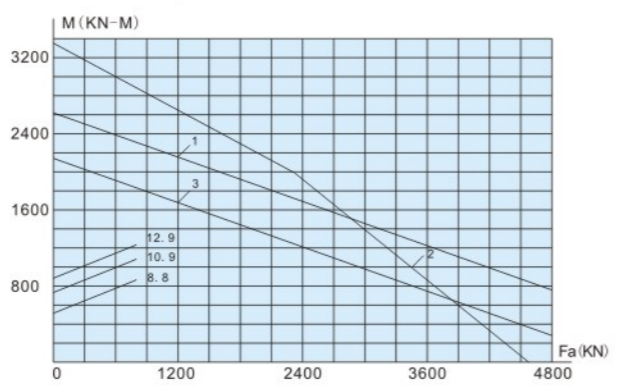

Fig. 1-245 787/1700KM

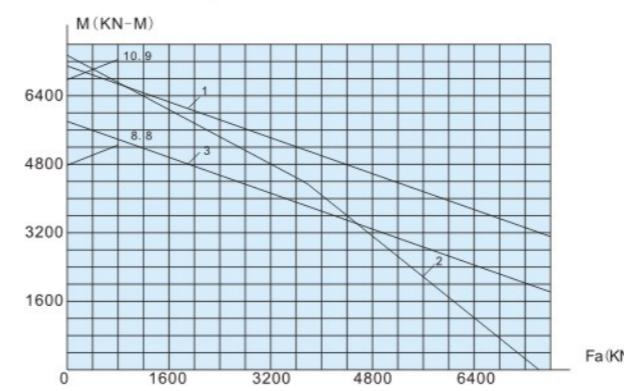

Fig. 1-252 787/2279

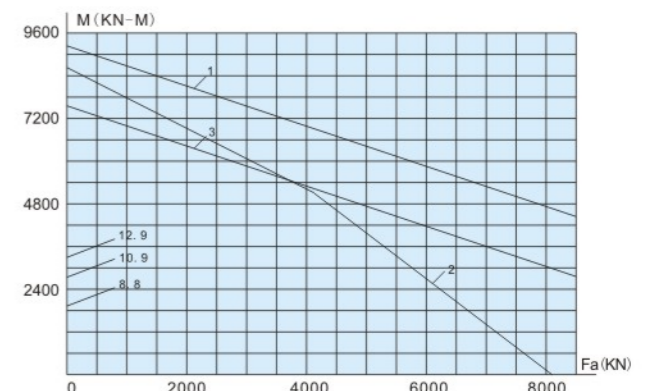

Fig. 1-253 010.60.2690.03

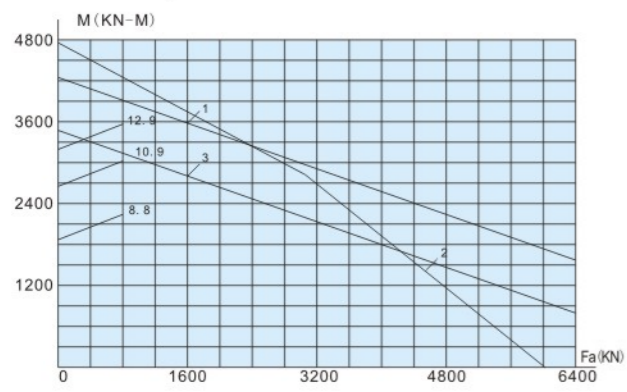

Fig. 1-246 787/1785

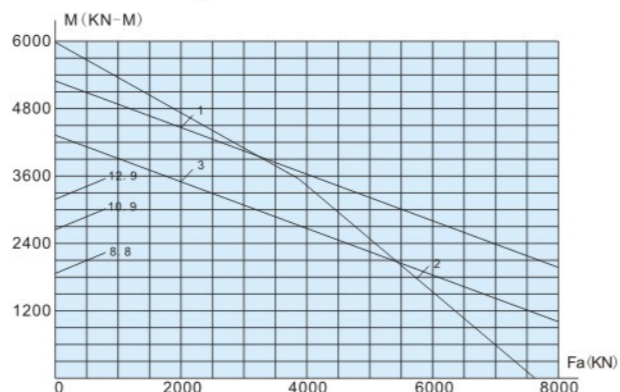

Fig. 1-247 787/1785G2

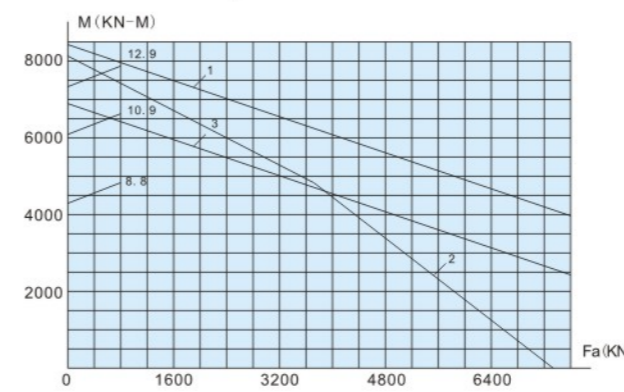

Fig. 1-254 010.60.2800.12

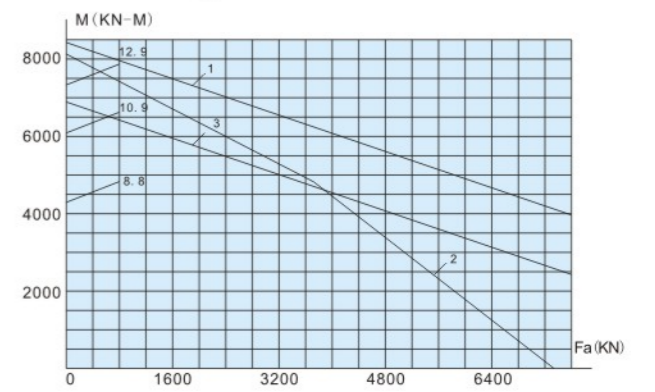

Fig. 1-255 787/2625K

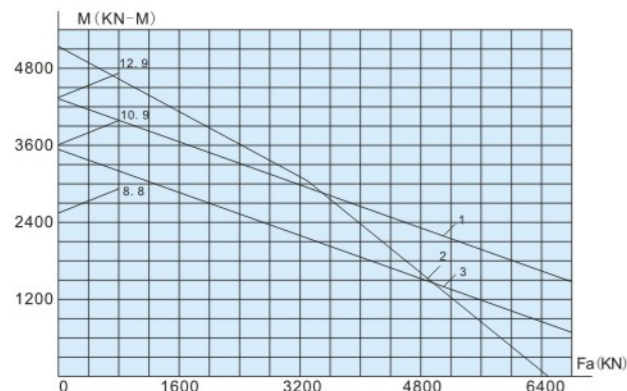

Fig. 1-248 010.60.2000.12

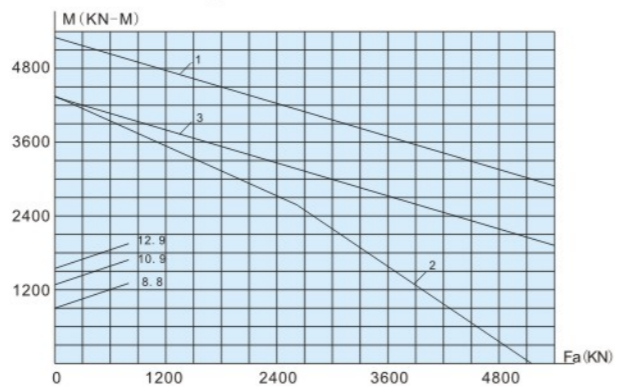

Fig. 1-249 787/1920

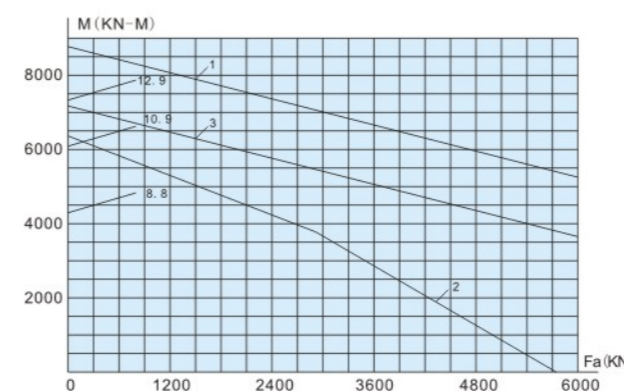

Fig. 1-256 787/2625

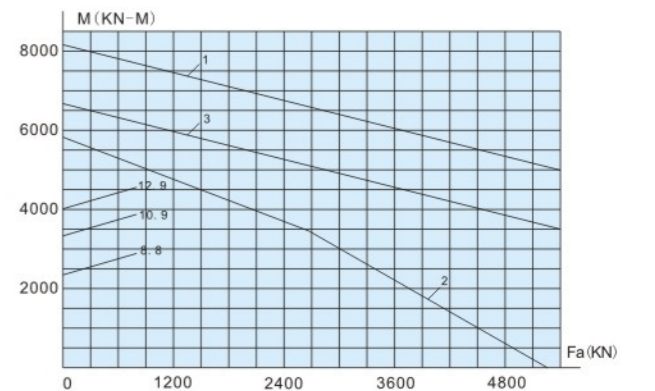

Fig. 1-257 010.40.2800.03K



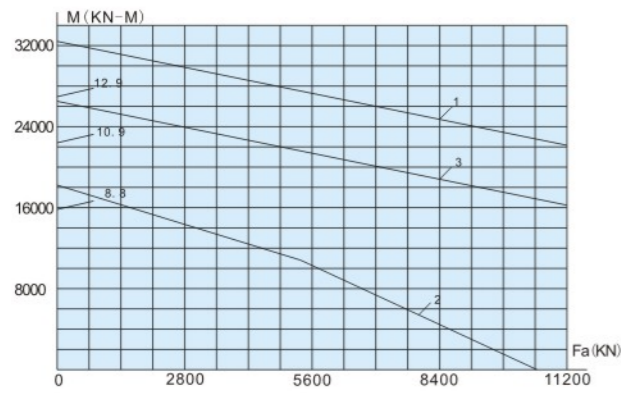

Fig. 1-258 010.70.4370.03

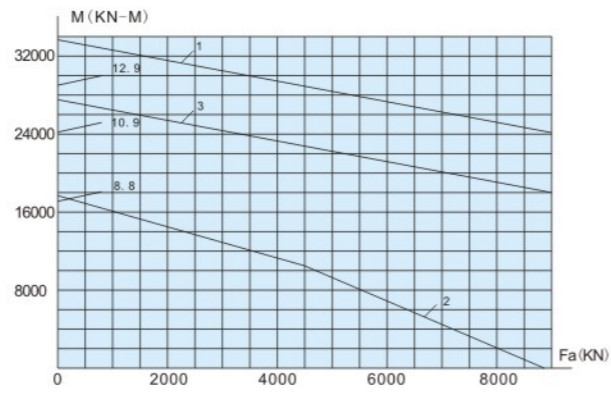

Fig. 1-259 787/4810

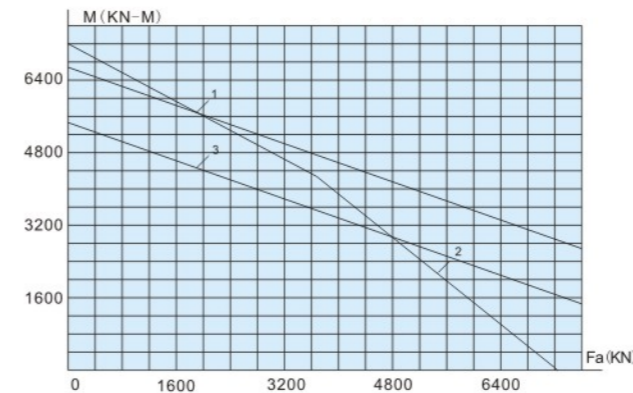

Fig. 1-267 LY-Q005

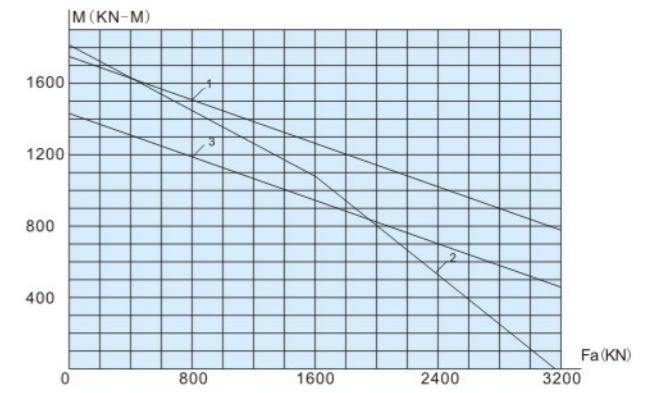

Fig. 1-268 1787/1305

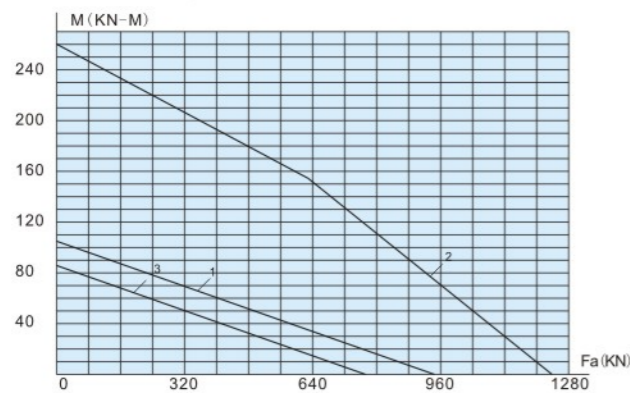

Fig. 1-260 176792K2M

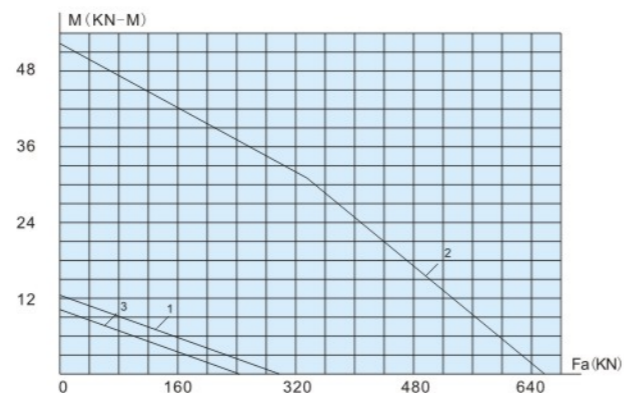

Fig. 1-261 010.20.200.12

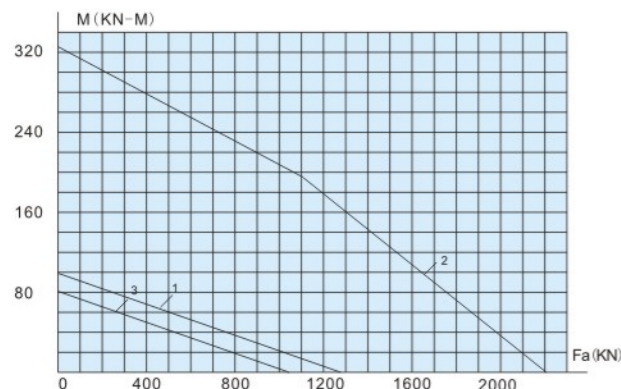

Fig. 1-262 116752K

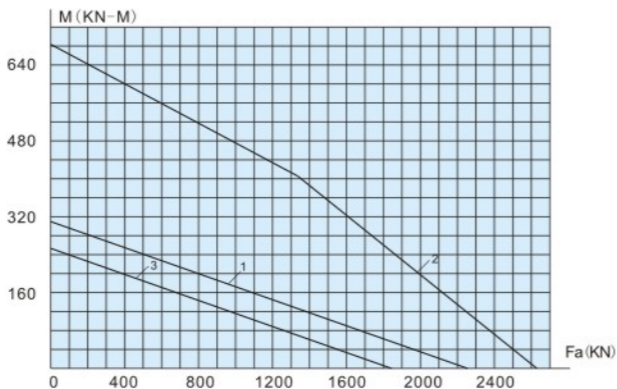

Fig. 1-263 1168/560

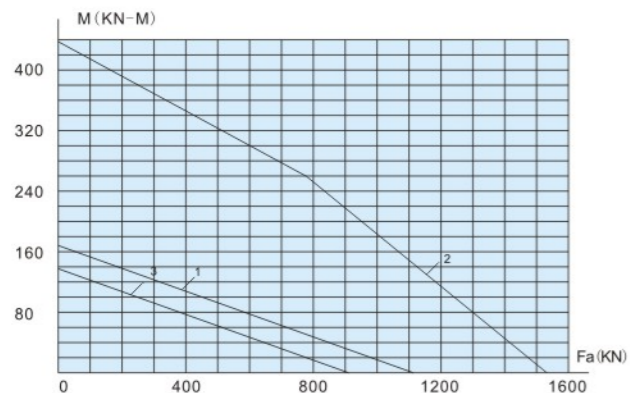

Fig. 1-264 11768/630

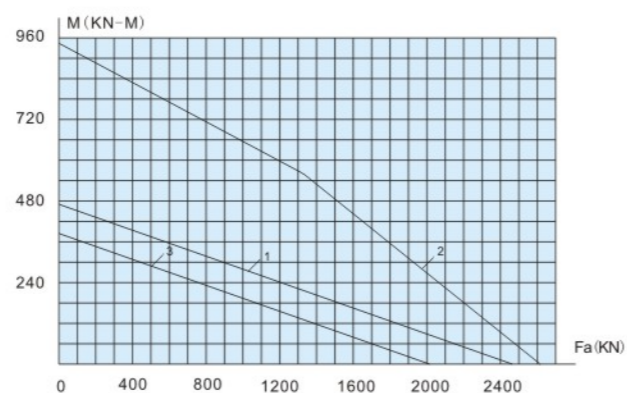
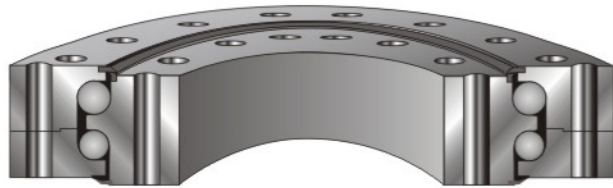

Fig. 1-265 LY-Q001



### Double-row Ball Slewing bearing



Type 020 (Type 578000)

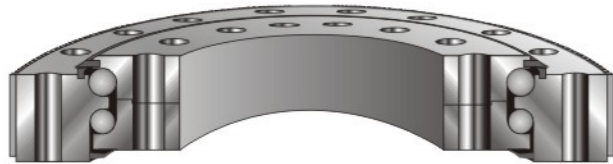

Type 021/022 (Type 678000)

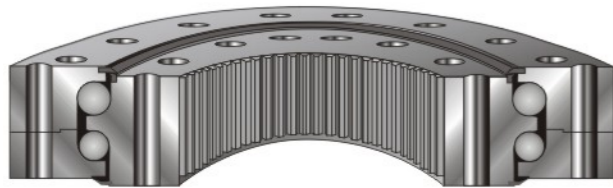

Type 023/024 (Type 778000)

▲ The design's of all these slewing rings are based on standard structures; LYC can design and manufacture many other similar structures in accordance to the special and particular requirements of their customers'. If our customer's have specific requests then the customer should identify the structure, and mounting dimensions that are required. Please contact the LYC Technical Center if you need any assistance in this area.

### Double-row Ball Slewing bearing

LYC double-row ball slewing bearing can carry axial load, tilting moment and radial loads at the same time. The top balls mainly carry the axial load and positive tilting moment. The drop balls take the opposite tilting moment. This is the reason why the loading capacity of the double row ball slewing bearing is larger than the four-point contact ball slewing bearing; however, the frictional ratio is larger than the latter.

LYC double-row ball slewing bearing consists of inner ring, outer ring, balls in double rows, spacers, sealing device, etc. Because the top balls mainly take the axial load and tilting moment, the size of top balls are larger than the drop balls. In order to

accommodate the various working condition at different axial load, tilting moments and axial load, the angle of contact would be adjusted accordingly.

The rings structure can be divided into two types, integral type and split type. Generally, the integral type maintains a stronger rigidity. The split type is more convenient to adjust; the two segregate rings are fastened by bolts before delivery.

LYC double-row slewing bearing has cages (or spacers) among the balls. Only when large loading is requested, would the full ball type be applied. Loading capacity for full ball type is definitely larger. However, the increased friction generated by this

design allows for the balls to be easily scratched.

The double-row slewing bearing is mainly for the working conditions when carrying axial load, larger tilting moment, and where the mounting place is limited in radial direction. This structure has smallest sensitive in mounting precision and deformation in axial and radial direction.

The basic structures of LYC double-row ball slewing bearing as below:

- Without gear (Type 020)
- External gear (Type 021/022)
- Internal gear (Type 023/024)

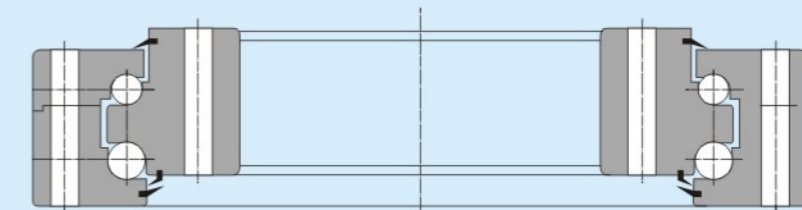

Type 020 (Type 578000)

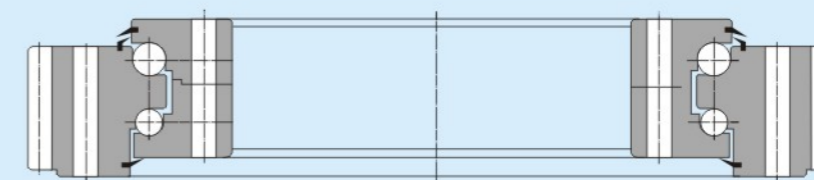

Type 021/022 (Type 678000)

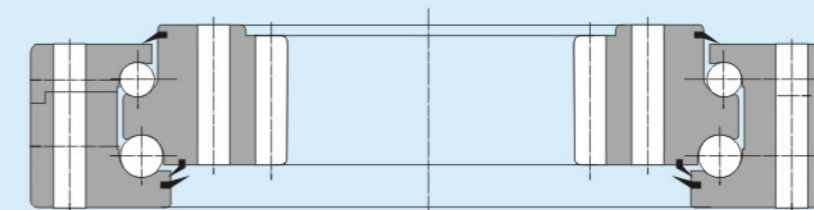

Type 023/024 (Type 778000)



### Double-row Ball Slewing bearing-with Internal Teeth

d1195~2872mm

Boundary Dimension			Bearing Type	Related Dimension										
d	D	T		D1	d1	d2	Dwp	H	h	n1	n2	n3	φ1	φ2
mm			mm											
1195	1550	160	8787/1195	1450	1250	1348	1350	150	10	8	48	48	ZG1/4	33
1310	1600	135	7787/1310G	1550	1365	1414	1465	140	5	4	32	32	M10×1	26
1344	1635	142	8787/1344	1575	1400	1481	1488	132	10	8	44	44	M10×1	30
1716	2080	168	8787/1716K	2000	1800	1899	1900	158	10	9	54	54	M14×1.5	32
1716	2080	168	8787/1716K1	2000	1800	1899	1900	158	10	8	54	54	M10×1	33
1727	2053	150	8787/1727	1984	1800	1885	1892	138	12	6	54	60	12	33
2000	2400	169	8787/2000	2320	2110	2208	2215	159	10	10	64	80	M10×1	33
—	3040	181	024.40.2875.03	2975	2775	2835	2875	155	36	6	60	60	ZG3/8	M33
—	3075	198	024.45.2895.03	3005	2775	2850	2895	168	43	6	60	60	M10×1	M36
—	3100	181	023.40.2940.03	3040	2805	2904	2940	161	40	6	60	60	M10×1	26
2728	3100	210	7787/2728K	3040	2780	2874	2930	200	42	4	36	36	M14×1.5	26
2872	3428	226	023.60.3150.03	3338	2962	3108	3160	214	56	8	56	56	M10×1	45
—	3455	217	024.50.3250.03	3365	3140	3206	3250	192	47	6	68	68	ZG3/8	M36
—	3455	222	024.50.3250.03K	3365	3140	3206	3250	202	47	6	68	68	ZG3/8	M36
—	3503	240	024.60.3310.03	3435	3190	3255	3310	214	26	8	88	88	ZG3/8	M33

φ3	Gear Parameter					Weight kg ≈	Loading Curve
	da	b	m	Z	x		
33	1142	100	10	115	0.5	796	Fig. 2-1
26	1214.4	100	16	77	0.25	691	Fig. 2-2
30	1284	80	12	108	0.5	640	Fig. 2-3
33	1657.3	100	12	139	0.5	1230	Fig. 2-4
33	1657.3	100	12	139	0.5	1230	Fig. 2-4
33	1652	120	14	119	0	1000	Fig. 2-5
33	1944	120	12	163	0.5	1563	Fig. 2-6
36	2600.4	145	22	118	1	1843	Fig. 2-7
39	2600.4	155	22	118	1	2298	Fig. 2-8
26	2626.5	141	16	165	0.5	2194	Fig. 2-9
25	2652	105	10	266	0.6	2537	Fig. 2-10
45	2760	150	20	139	0.5	4019	Fig. 2-11
39	2952	170	24	123	1	2899	Fig. 2-12
39	2952	175	24	123	1	3028	Fig. 2-13
37	3000	190	24	126	0.5	3223	Fig. 2-14

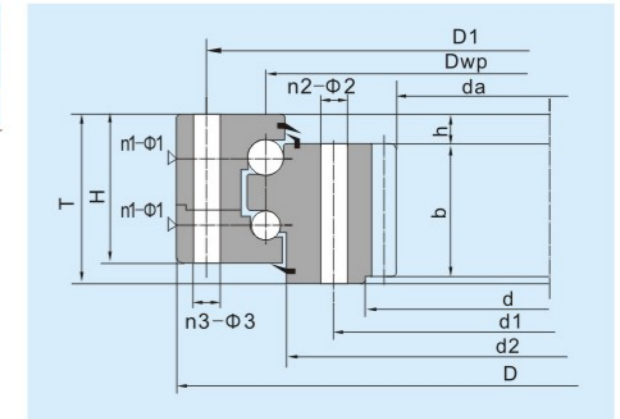



### Double-row Ball Slewing bearing-with External Teeth

d820~4470mm

Boundary Dimension			Bearing Type	Related Dimension									
d	D	T		D1	d1	d2	Dwp	H	h	n1	n2	n3	φ1
mm			mm										
820	1150	125	6787/820G	1100	880	1020	990	130	5	2×2	1	14/4	M10×1
978	1262	124	021.30.1120.12	1218	1022	1159	1120	114	29	6	36	36	M10×1
1074	1426	160	021.40.1250.12	1374	1126	1300	1250	150	39	8	40	40	M10×1
1224	1576	160	021.40.1400.12	1524	1272	1450	1400	150	39	8	40	40	M10×1
1224	1576	160	022.40.1400.12	1524	1272	1450	1400	150	39	5	40	40	M10×1
1424	1776	160	022.40.1600.12	1724	1476	1650	1600	150	39	5	45	45	M10×1
1600	2000	175	6787/1600G	1920	1675	1840	1790	190	15	4	20	10	M10×1
1600	2000	175	6788/1600G	1920	1675	1840	1790	190	15	4	24	24	M10×1
1624	1976	160	022.40.1800.12	1924	1676	1836	1800	150	39	5	45	45	M10×1
2135	2524	185	9787/2135	2436	2215	2331	2333	170	15	12	68	64	M10×1
2135	2524	185	9787/2135K	2436	2215	2331	2333	170	15	6	68	64	M10×1
2209	2470	90	021.25.2285.03	2340	2245	2306	2286	64	26	4	24	20	M10×1
2285	2715	190	021.50.2500.12	2649	2351	2538	2500	178	47	8	56	56	M10×1
2570	3040	195	9787/2570	2885	2665	2776	2778	165	15	8	94	96	M10×1
3405	3765	185	6789/3405G	3700	3465	3638	3570	185	45	12	48	48	M12×1.25
4470	5184	250	022.60.4700.03	4910	4565	4759	4700	238	65	10	60	60	M10×1

φ2		φ3		Gear Parameter					Weight kg ≈	Loading Curve
da	b	m	Z	x						
1	25/22	1206	75	12	99	-0.25	508	Fig. 2-15		
22	22	1318	80	10	129	0.5	391	Fig. 2-16		
26	26	1497.6	90	12	122	0.5	726	Fig. 2-17		
26	26	1644	90	12	134	0.5	803	Fig. 2-18		
26	26	1649.2	90	14	115	0.5	809	Fig. 2-18		
26	26	1852.8	90	16	113	0.5	967	Fig. 2-19		
38	38	2066.4	120	14	146	-0.2	1531	Fig. 2-20		
32	32	2154.6	140	6	358	-0.45	1576	Fig. 2-21		
26	26	2060.8	90	16	126	0.5	1088	Fig. 2-22		
39	M30	2616	147	20	128	0.5	1900	Fig. 2-23		
39	M30	2616	147	20	128	0.5	1900	Fig. 2-23		
M16	M16	2420	70	10	240	0	372	Fig. 2-24		
33	33	2804	120	18	153	0.5	2031	Fig. 2-25		
39	M36	3141.6	170	22	140	0.5	2730	Fig. 2-26		
35	35	3852	120	18	212	0	2632	Fig. 2-27		
33	33	5184	155	18	286	0	7630	Fig. 2-28		

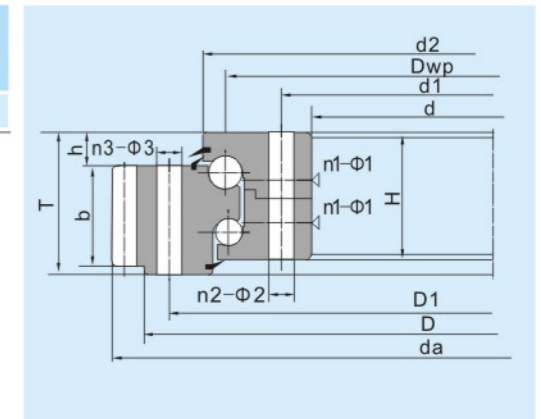



### Double-row Ball Slewing bearing-without Teeth

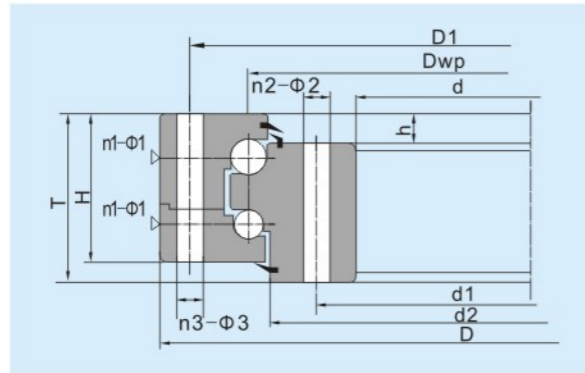

d260~3245mm

Boundary Dimension			Bearing Type	Related Dimension													Weight	Loading Curve
d	D	T		D1	d1	d2	Dwp	H	h	n1	n2	n3	φ1	φ2	φ3	kg ≈		
mm			mm															
260	385	55	D787/260	365	280	313	314.673	55	0	3	33	33	3	9.3	9.3	18.5	Fig. 2-29	
978	1262	124	020.30.1120.12	1218	1022	1159	1120	124	29	6	36	36	M10×1	22	22	343	Fig. 2-30	
1074	1426	160	020.40.1250.12	1374	1126	1300	1250	121	39	8	40	40	RC1/4	26	26	652	Fig. 2-31	
1916	2320	150	787/1916G2	2245	1980	2146	2115	130	15	12	42	42	M12	34	34	1251	Fig. 2-32	
2530	2820	156	020.40.2685.03	2775	2580	2651	2685	150	39	6	60	60	M10×1	26	26	1173	Fig. 2-33	
3245	3683	230	020.60.3485.03	3620	3315	3420	3487	220	10	12	52	52	M10×1	39	39	3240	Fig. 2-34	



**Loading Curve**

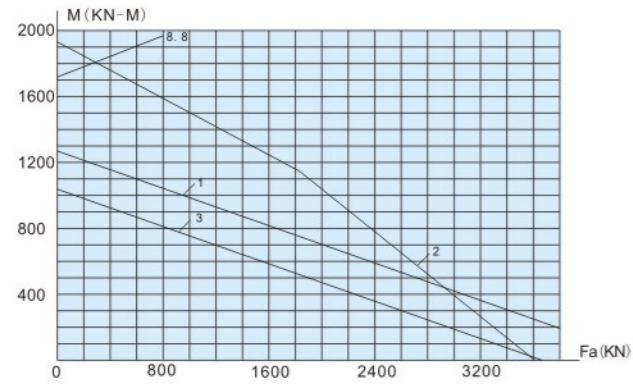

Fig. 2-1 8787/1195

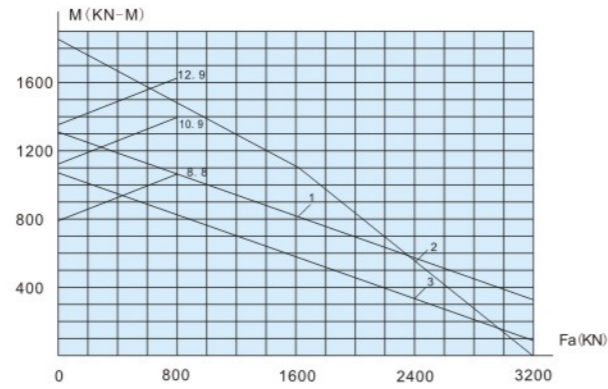

Fig. 2-2 7787/1310G

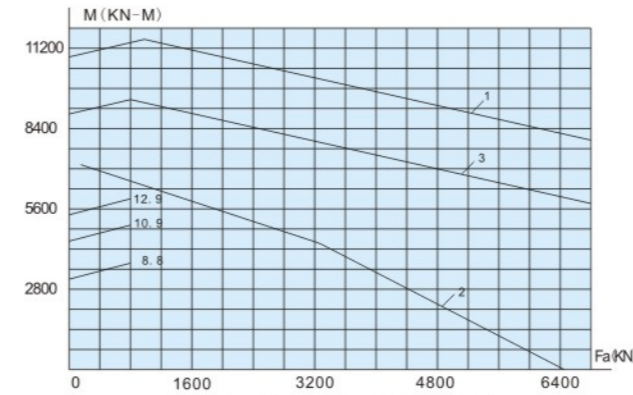

Fig. 2-9 023.40.2940.03

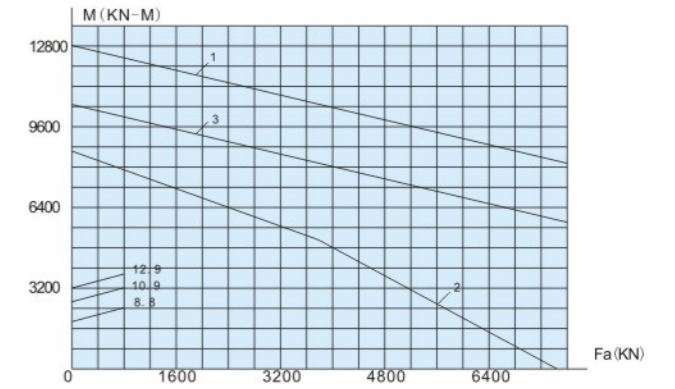

Fig. 2-10 7787/2728K

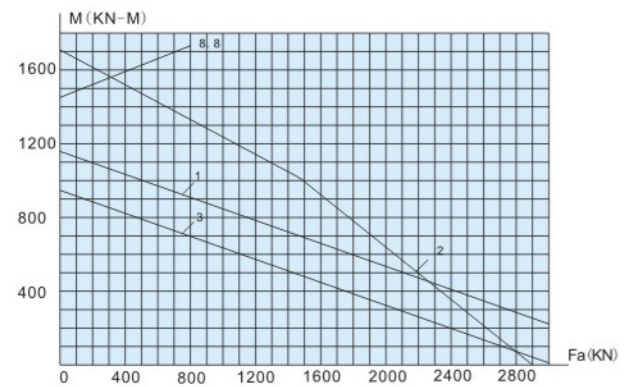

Fig. 2-3 8787/1344

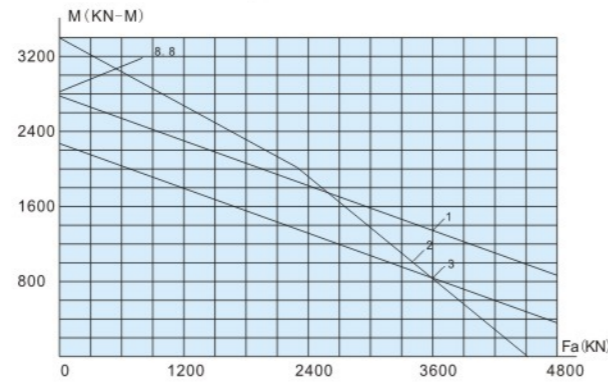

Fig. 2-4 8787/1716K

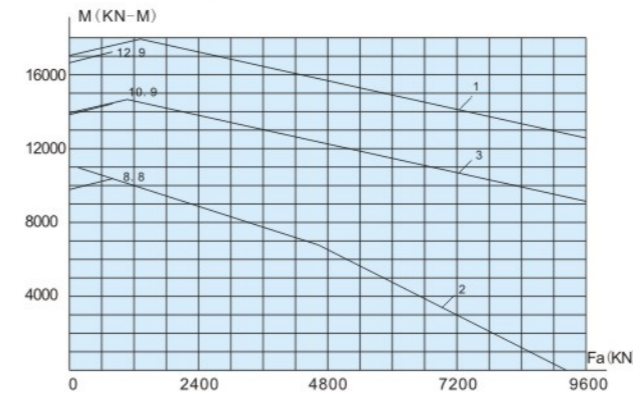

Fig. 2-11 023.60.3150.03

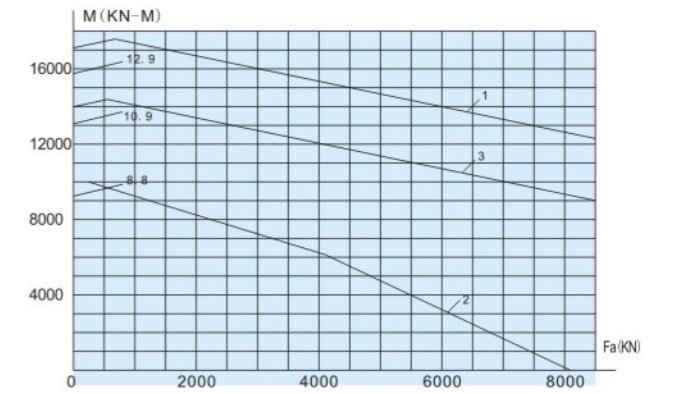

Fig. 2-12 024.50.3250.03

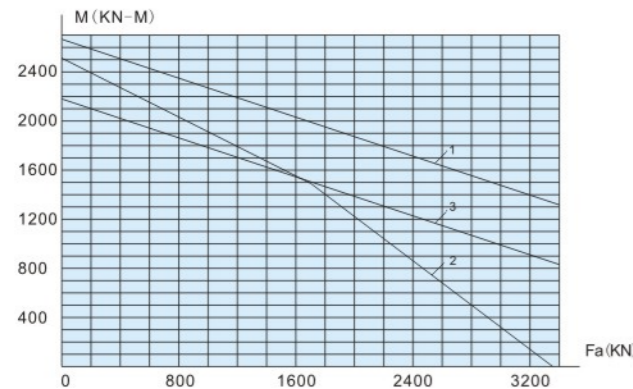

Fig. 2-5 8787/1727

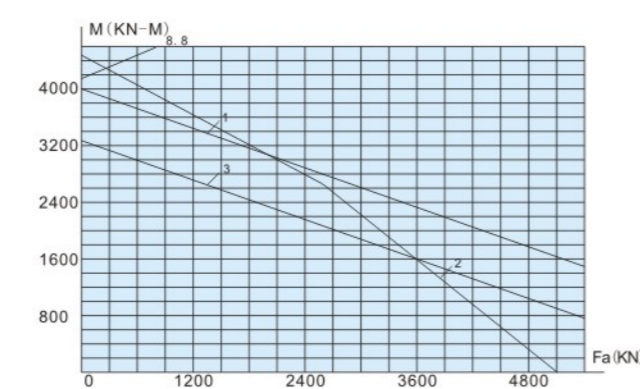

Fig. 2-6 8787/2000

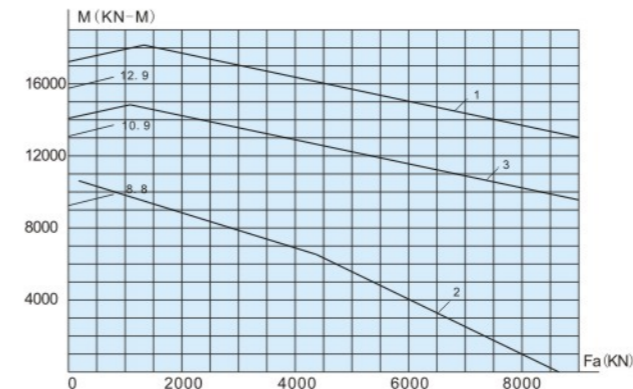

Fig. 2-13 024.50.3250.03K

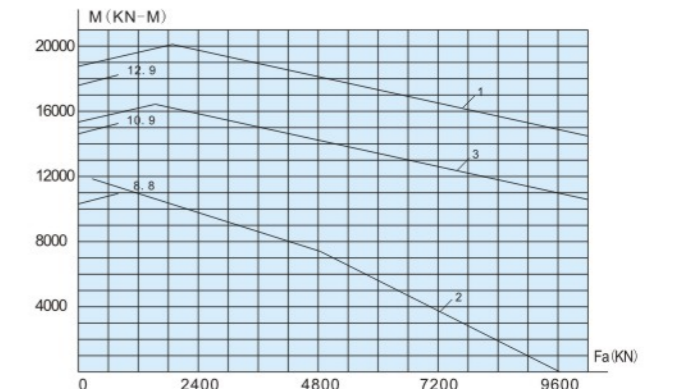

Fig. 2-14 024.60.3310.03

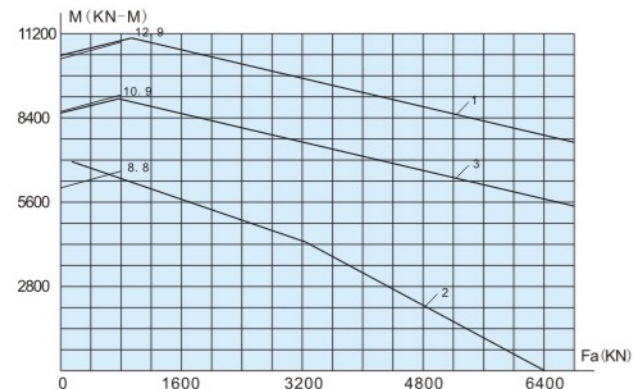

Fig. 2-7 024.40.2875.03

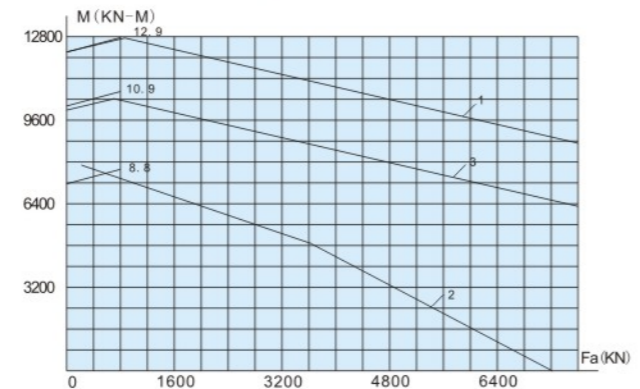

Fig. 2-8 024.45.2895.03

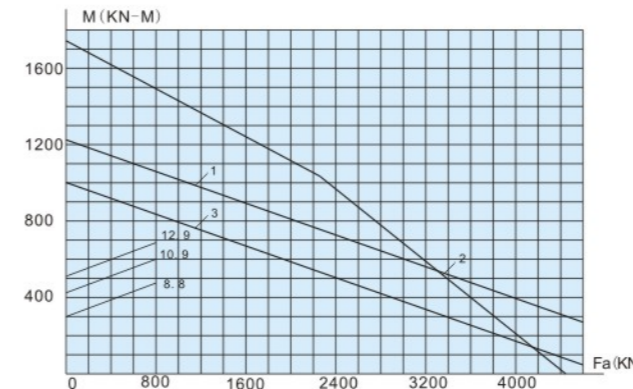

Fig. 2-15 6787/820G

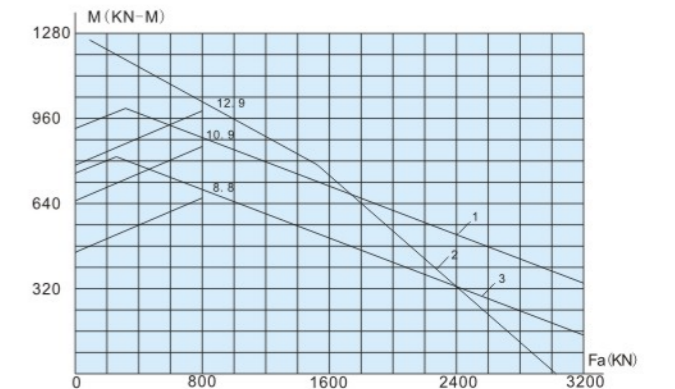
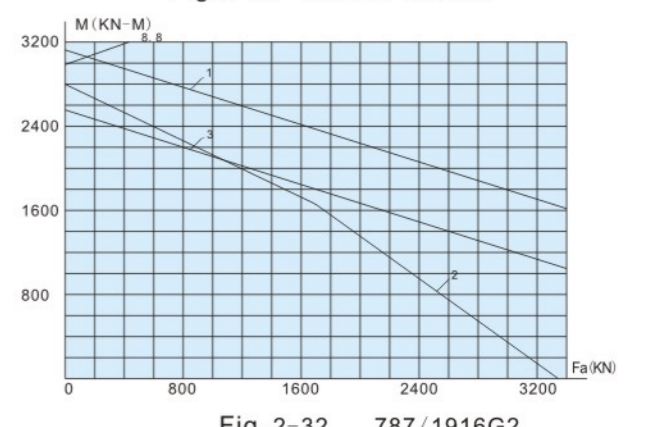
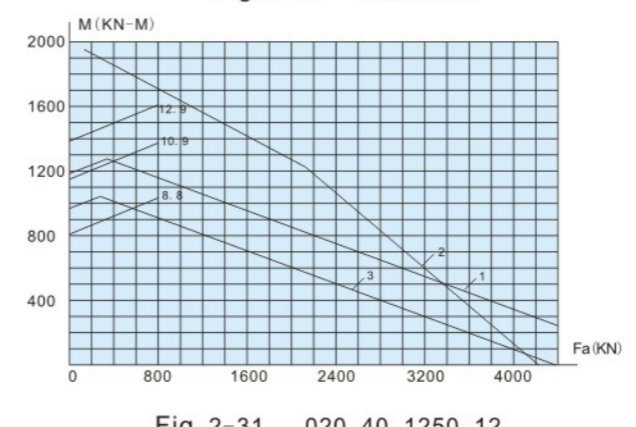
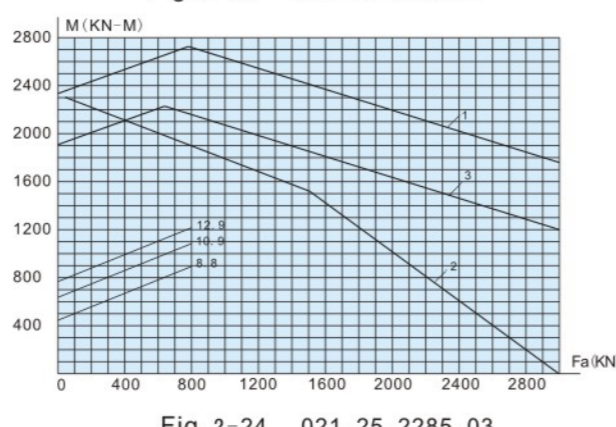
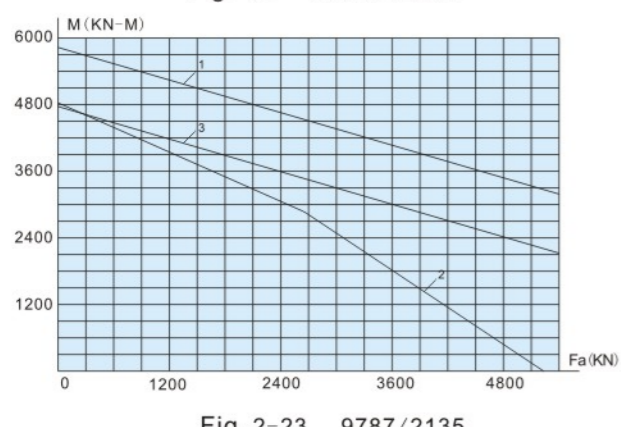
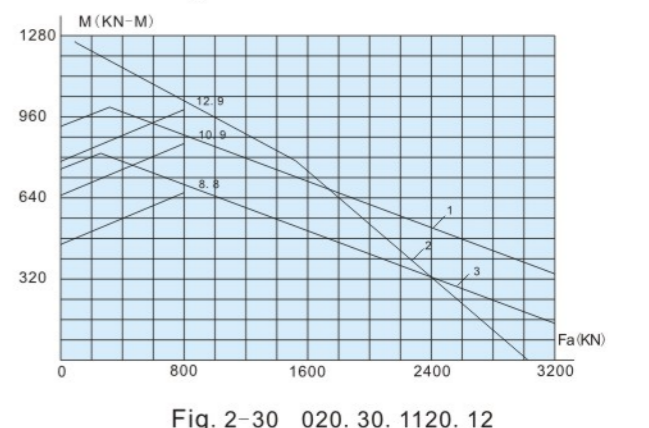
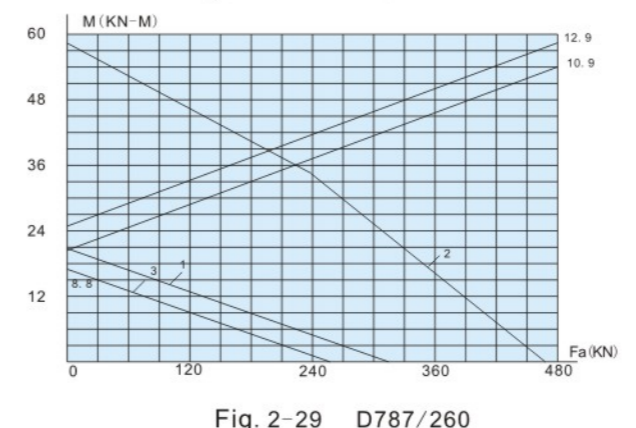
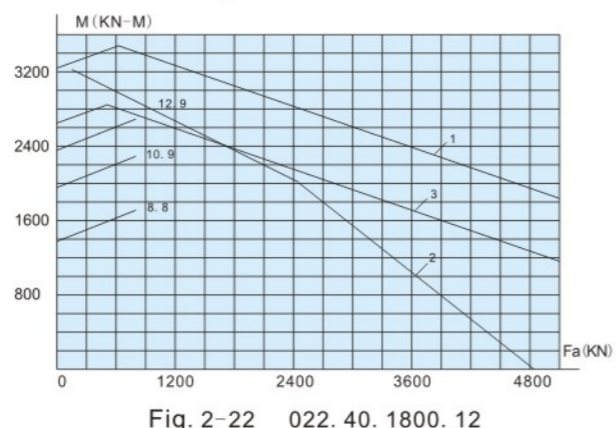
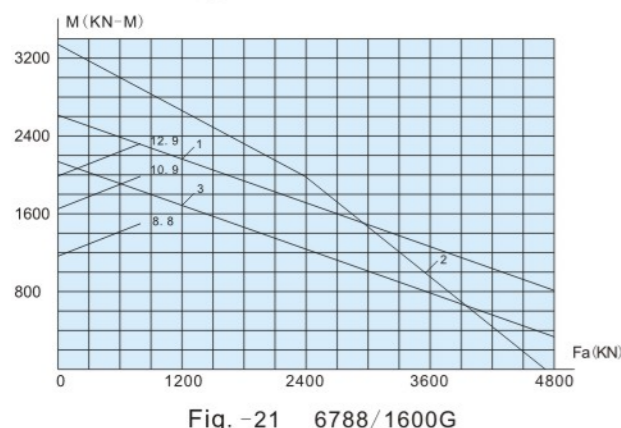
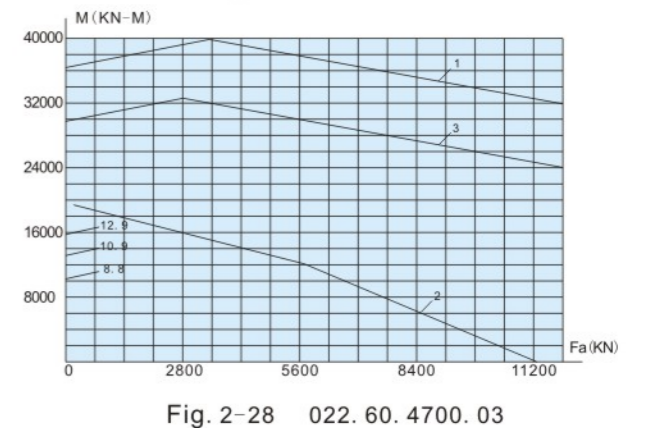
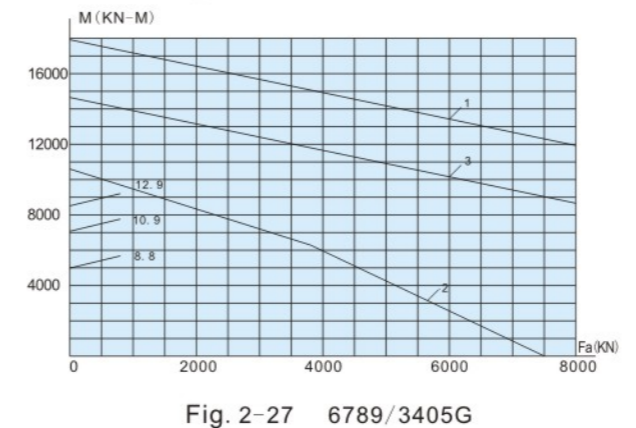
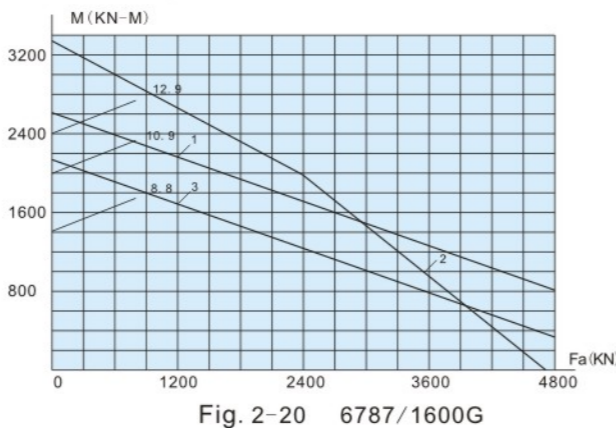
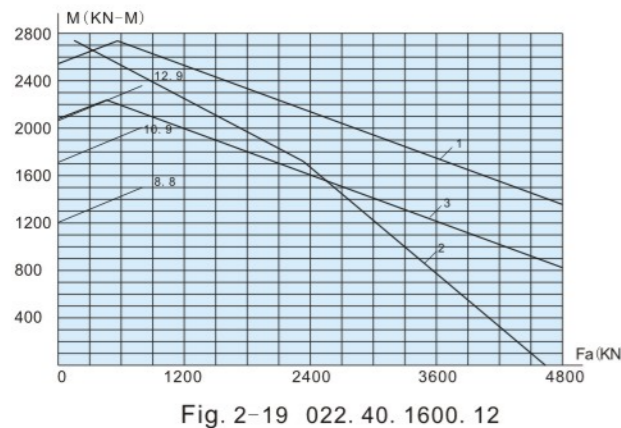
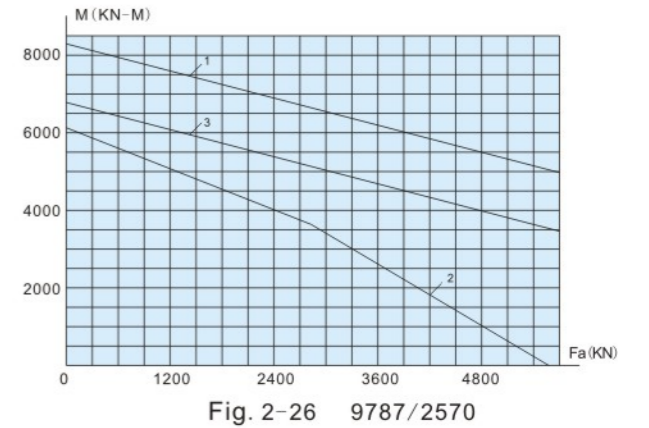
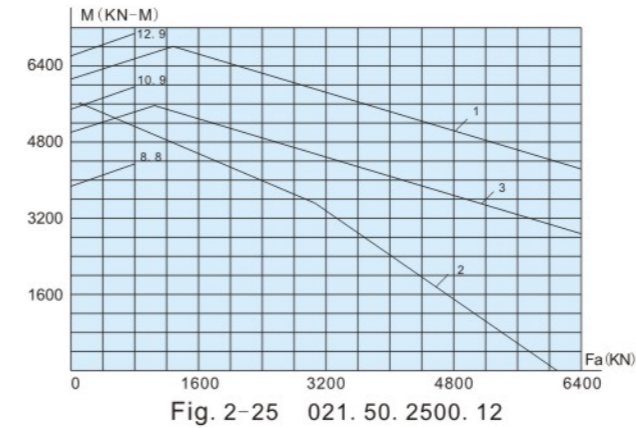
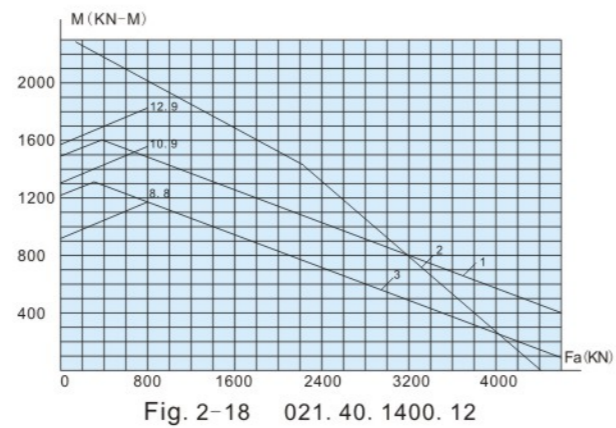
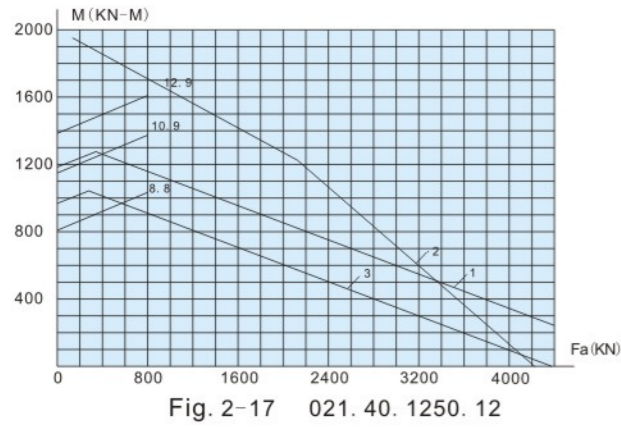

Fig. 2-16 021.30.1120.12







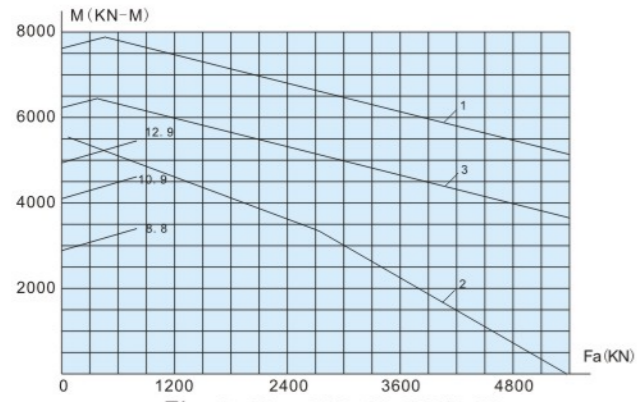

Fig. 2-33 020.40.2685.03

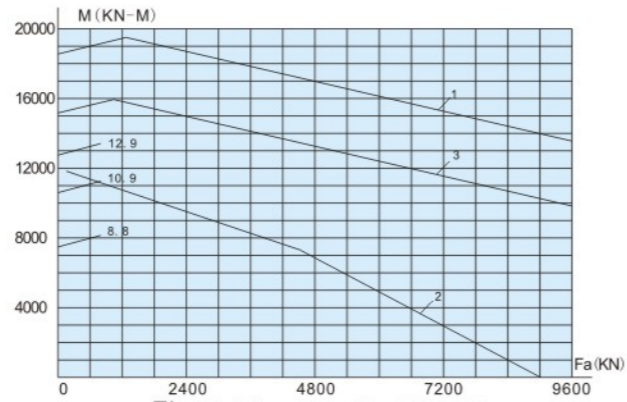
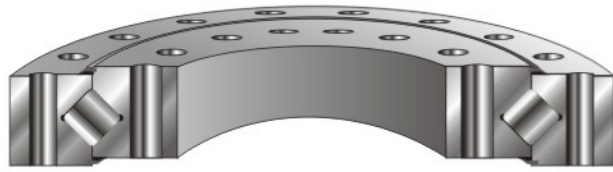

Fig. 2-34 020.60.3485.03



Cross Cylindrical Roller Slewing Bearing



Type 110 (Type 79000)

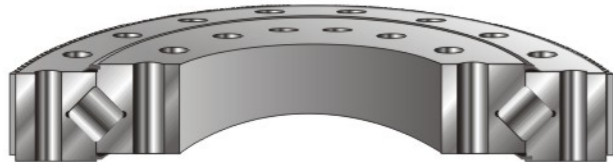

Type 111/112 (Type 179000)

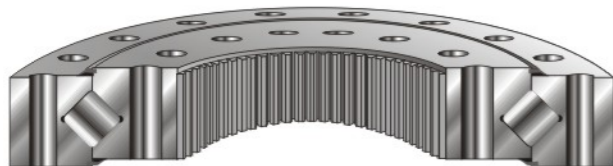

Type 113/114 (Type 279000)

▲ The design's of all these slewing rings are based on standard structures; LYC can design and manufacture many other similar structures in accordance to the special and particular requirements of their customers'. If our customer's have specific requests then the customer should identify the structure, and mounting dimensions that are required. Please contact the LYC Technical Center if you need any assistance in this area.

Cross Cylindrical Roller Slewing Bearing

LYC cross cylindrical roller slewing bearing can carry axial load, tilting moment and radial load all at the same time. The design and application of the cross cylindrical roller slewing bearings are basically the same as those of the four point contact ball slewing bearing, except that the rolling elements are substituted from balls into rollers and the contact way between the rolling elements and rings is changed from point contact into line contact. Those changes allow for the carrying capacity to be increased, but the wear and the friction moment load are also increased.

LYC's cross cylindrical roller slewing bearings are composed of a inner ring, outer ring, a single row of rollers,

cage (spacer), and seal device etc.

In this design, their cylindrical rollers in axis direction is cross-distribution. The length-diameter ratio of cylindrical roller is less than 1. It would cause slight movement when rollers' running.

LYC cross cylindrical roller slewing bearing can carry different combined forces caused by axial load, tilting moment and radial load in different working condition, by adjusting the quantity of crossed rollers and contact angle.

There are integral and separate rings in the structure of LYC cross cylindrical roller slewing bearing. Cages or spacers are usually adopted within design in order to ease friction.

rollers and raceway contact.

This slewing bearing with a design of a full complement of rollers is mainly applied in the condition where a heavier axial load is the primary load, and the requirement for tilting moment and friction moment is not so high.

The basic structures of LYC cross cylindrical roller slewing bearing as below:

- Without gear (Type 110)
- External gear (Type 111/112)
- Internal gear (Type 113/114)

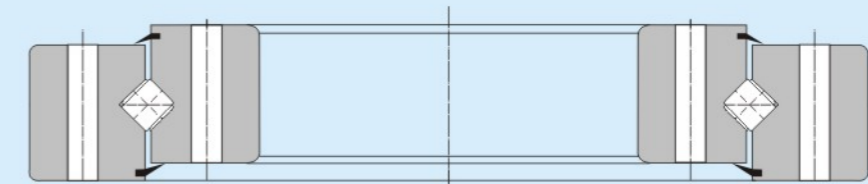

Type 110 (Type 79000)

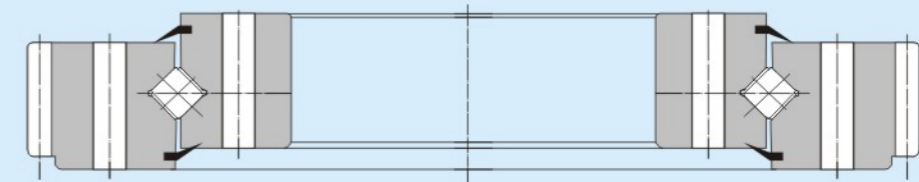

Type 111/112 (Type 179000)



Type 113/114 (Type 279000)



### Cross Cylindrical Roller Slewing Bearing-With Internal Teeth

d695~3780mm

Boundary Dimension			Bearing Type	Related Dimension										
d	D	T		D1	d1	d2	H	h	Dwp	n1	n2	n3	φ1	φ2
mm			mm											
695	920	90	2797/695G2	870	735	800	76	4	802	3	30	30	10	18
760	1000	95	2797/760G2	956	800	878	82	15	880	4	24	24	M10×1	20
870	1180	115	2797/870G2	1125	920	1023	100	15	1025	2	18	18	M8×1	26
875	1170	95	2797/875G2	1120	930	1018	82	15	1020	4	24	24	M10×1	22
955	1200	90	2797/955G	1160	1000	1088	76	14	1090	4	18	36	M8×1	18
955	1200	90	2797/955G2	1160	1000	1088	76	14	1090	4	18	36	M8×1	18
1010	1200	90	2797/1010G2	1160	1041	1088	76	10	1090	2	20	36	M8×1	M20
1010	1200	90	2797/1010GK	1160	1041	1088	76	10	1090	2	20	36	M8×1	M20
—	1216	100	113.28.1094.03	1172	1013	1092	90	10	1094	4	12	12	M10×1	M18
1278	1595	120	2797/1278G2	1535	1335	1428	106	14	1430	6	36	36	M10×1	26
1400	1715	110	2792/1400G2K	1660	1460	1558	95	15	1560	4	40	40	M10×1	M24
1424	1776	160	113.40.1600.03K	1724	1476	1598.5	150	39	1600	5	45	45	M10×1	26
1665	2002	156	113.45.1830.11	1940	1720	1827	128	28	1830	6	54	54	M10×1	30
2100	2335	160	2792/2000G2	2350	2070	2207	140	20	2210	6	48	48	M10×1	M30
2032	2335	124	2797/2032	2280	2144	2206	80	20	2208	6	64	64	M10×1	M20
2240	2670	160	2792/2240G	2600	2320	2457	140	20	2460	6	54	54	M12×1.25	M36
2300	2800	208	3-940G	2710	2390	2535	180	18	2540	6	48	42	M10×1	M36
2325	2678	162	D2797/2325	2610	2391	2498	145	17	2500	8	56	56	M10×1	33
2680	3325	300	2797/2680GY	3242	2754	2996	270	30	2998.48	4	48	48	M16×1.5	33
2680	3325	300	2797/2680GK	3242	2754	2996	270	30	2998.48	4	32	32	M16×1.5	33
2680	3325	300	2797/2680G	3242	2754	2996	270	30	2998.48	4	32	32	M16×1.5	33
—	3100	110	2797/2768	3052	2897	2972	94	16	2974.5	10	60	60	M10	24
3322	3850	200	3-943G2	3720	3420	3568	180	22	3570	12	60	60	Z1/4	45
3780	4500	260	2797/3780G2	4400	3900	4055	238	32	4150	12	64	60	M16×1.5	40

φ3	Gear Parameter					Weight kg ≈	Loading Curve
	da	b	m	Z	x		
18	658	65	7	96	0	175	Fig.3-1
20	718.18	70	8	91	0.35	206	Fig.3-2
26	828.8	90	8	105	0.3	374	Fig.3-3
22	830.1	70	8	105	0.35	297	Fig.3-4
18	908.8	72	8	115	0.3	245	Fig.3-5
18	908.8	72	8	115	0.3	245	Fig.3-5
22	962	72	10	97	0.6	199	Fig.3-6
22	962	72	10	97	0.6	199	Fig.3-6
22	920	90	10	94	0	326	Fig.3-7
26	1221.14	90	12	103	0.35	585	Fig.3-8
26	1330	90	10	135	0	587	Fig.3-9
26	1349.6	90	14	97	0.5	924	Fig.3-10
30	1610	100	12	135	0.5	912	Fig.3-11
33	1913.5	120	14	138	0.3	1607	Fig.3-12
22	2032	100	14	147	0	630	Fig.3-13
35	2154.5	120	16	136	0.3	1798	Fig.3-14
38	2162.75	175	20	110	0	2756	Fig.3-15
33	2234.4	110	12	188	0	1627	Fig.3-16
33	2592	180	16	164	0	6320	Fig.3-17
33	2592	180	16	164	0	6641	Fig.3-18
33	2592	180	16	164	0	6320	Fig.3-19
24	2768	100	16	175	0	975	Fig.3-20
45	3206.368	158	22	147	0.35	4520	Fig.3-21
40	3668.24	190	22	168	0.35	8346	Fig.3-22

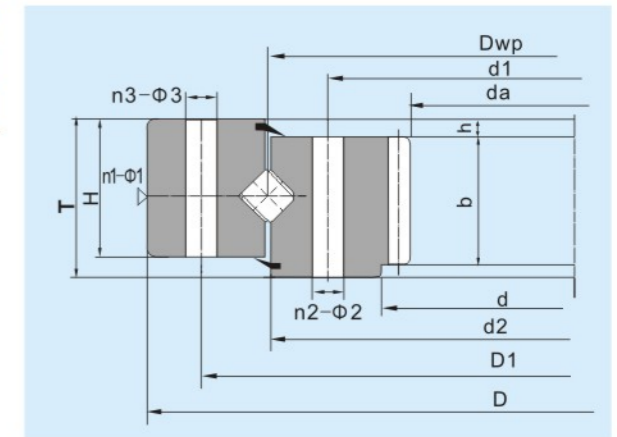



### Cross Cylindrical Roller Slewing Bearing-With External Teeth

D235~2500mm

Boundary Dimension			Bearing Type	Related Dimension									
d	D	T		D1	d1	d2	H	h	Dwp	n1	n2	n3	φ1
mm			mm										
235	380	55	1797/235	358	259	308	45	8	308.5	2	27	24	ZG1/4
270	—	86	179254G2	456	300	386	81	5	387	3	9	9	ZG1/4
400	—	80	1797/400	575	450	519	70	10	520	-	8	12	-
545	867	132.5	LY-8013	805	611	693	122	10.5	695	4	35	40	G1/4
574	781	90	111.25.675.03K/P6	753	604	675.5	71	16	677	3	18	18	M10×1
664	890	75	1797/664	847	705	774	65	10	776	4	35	36	M10×1
608	812	75	111.25.710.12K	776	644	708.5	65	10	710	4	24	24	M10×1
715	935	100	1797/715	893	753	821.5	84	16	823	4	28	28	M10×1
736	—	56	D1797/736G2	885	798	840	44.5	11.5	844	4	40	36	M10×1
678	922	82	111.28.800.12	878	722	798.5	72	10	800	6	30	30	M10×1
885	1056	83	1792/885	1032	925	986	75	12.5	987	-	16	16	-
885	1056	83	E1792/885	1032	925	986	75	12.5	987	-	16	16	-
885	1056	83	E1792/885K	1032	925	986	75	12.5	987	3	16	16	M10×1
885	1150	115	1797/885G	1115	935	1023	100	15	1025	4	16	16	M8×1
1080	1475.5	110	112.36.1250.03	1350	1150	1248	100	21	1250	4	28	24	M10×1
1100	1400	140	1798/1100G2	1352	1160	1260	126	21	1262	4	26	26	M10×1
1100	1400	145	1798/1100G2K	1352	1160	1260	131	26	1262	4	26	26	M10×1
1100	1415	115	1797/1100G	1345	1160	1253	100	15	1254	4	18	24	M12×1.25
1100	1400.00	140	1798/1100G2K1/P5	1352	1160	1260	119	14	1262	4	26	26	4
1250	1548	148	1797/1250G2	1512	1297	1403	122	20	1405	4	16	16	M10×1
1278	1595	120	1797/1278G2	1535	1335	1428	105	15	1430	4	36	36	M10×1
1300	1705	165	1797/1300G2	1644	1360	1504	134	31	1506	4	24	24	M10×1
1400	1715	110	1792/1400G	1660	1460	1558	95	17	1560	4	42	42	M12×1.25
1400	1715	110	1792/1400G2	1660	1460	1558	95	17	1560	4	42	42	M12×1.25
1400	1715	110	1792/1400G2K	1660	1460	1558	95	17	1560	4	42	42	M12×1.25
1400	1715	110	E1792/1400G2K2	1660	1460	1558	95	17	1560	4	24	24	M12×1.25
1400	1788	110	D1792/1400G2K1	1660	1460	1558	95	15	1560	4	24	24	M12×1.25
1460	1800	125	1797/1460G2	1735	1525	1633	110	10	1635	4	36	32	M10×1
1460	-	125	1797/1460G2K	1735	1525	1633	110	10	1635	4	36	32	M10×1
1460	1740	91	111.32.1600.04	1687	1513	1598	81	10	1600	5	45	45	M10×1
1722	2020	123	1797/1722	1960	1780	1868	110	13	1870	12	36	36	M10×1
1785	2178	220	1797/1785	2110	1851	1977.5	210	20	1980	14	48	48.0	M10×1
1825	2178	112	111.40.2000.11	2110	1891	1998	100	12	1993	8	48	48	M10×1
1914	—	190	1797/1914	2245	1980	2110	120	10	2112.5	14	42	42	M10×1
1915	2420	140	1797/1915G2	2320	1980	2113	130	20	1643	8	40	40	M10×1
1916	—	150	1797/1916G2	2245	1980	2113	130	15	2115	3	42	42	M10×1
2100	2600	180	1797/2100G2	2540	2200	2368	158	22	2370	8	48	48	M10×1
2100	2600	180	1797/2100G2K	2540	2200	2368	158	22	2370	8	48	48	M10×1
2100	2600	180	1797/2100G2K1	2540	2200	2368	158	22	2370	8	48	48	M10×1
2100	2600	180	1797/2100G2K2	2540	2200	2368	158	22	2370	8	48	48	ZG1/4
2460	—	220	1797/2460G2	2930	2560	2785	185	20	2746	30	30	30	M12×1.25
2460	—	220	1797/2460G2K	2930	2560	2785	185	20	2746	15	30	30	ZG1/4
2460	—	220	1797/2460G2K1	2930	2560	2785	200	185	2746	30	30	30	ZG1/4
2460	—	220	1797/2460G2K2	2930	2560	2785	185	20	2746	30	30	30	ZG1/4
2460	—	220	1797/2460G2U	2930	2560	2745	185	20	2746	30	30	30	M12×1.25
2500	2920	260	1797/2500K	3060	2622	2949	240	60	2820	36	36	36	ZG1/4
2500	2920	270	1797/2500K1	3060	2622	2949	250	60	2820	18	36	36	ZG1/4
2500	2920	260	1797/2500K2	3060	2622	2949	240	60	2820	18	36	36	ZG1/4
2500	—	210	1797/2500K3	2990	2630	2818	200	10	2820	12	36	36	M10×1
2500	2920	260	1797/2500K4	3060	2622	2949	240	60	2820	36	36	36	ZG1/4

φ2	φ3	Gear Parameter					Weight kg ≈	Loading Curve
		da	b	m	Z	x		
13	13	403.5	39	4.5	88	0	24	Fig.3-23
18	M16	520	80	8	63	0	70	Fig.3-24
20	M20	656	80	8	80	0	108	Fig.3-25
M27	30	920	90	10	90	0	290	Fig.3-26
22	22	816	65	6	132	1.092	125	Fig.3-27
22	22	929.6	60	8	115	-0.4	133	Fig.3-28
18	M16	846	60	6	139	0	118	Fig.3-29
22	22	979	63	10	94	1.1	173	Fig.3-30
½(美制)	½(美制)	944	44.5	4	234	0	80.9	Fig.3-31
22	22	968	65	8	632	0.5	161	Fig.3-32
17.5	M16	1096	62.5	8	135	0	172	Fig.3-33
17.5	M16	1096	62.5	8	135	0	172	Fig.3-33
17.5	M16	1096	62.5	8	135	0	172	Fig.3-33
18	18	1180	80	5	234	0	330	Fig.3-34
M27	27	1475.5	75	10	144	0.86	542	Fig.3-35
26	24	1477.28	90	14	104	-0.24	642	Fig.3-36
26	24	1477.28	90	14	104	-0.24	644	Fig.3-36
21	21	1452	84	6	240	0	502	Fig.3-37
26	M22	1477.28	90	14	104	-0.24	651	Fig.3-38
25	25	1608	100	12	132	0	661	Fig.3-39
26	26	1655.46	90	12	134	1.15	597	Fig.3-40
32	32	1783.6	85	14	126	-0.3	1023	Fig.3-41
26	26	1780.8	78	12	147	-0.3	579	Fig.3-42
26	26	1881.6	78	12	147	-0.3	579	Fig.3-42
26	26	1780.8	78	12	147	-0.3	579	Fig.3-42
M24	M24	1788	78	12	147	0	595	Fig.3-43
M24	M24	1788	78	12	147	0	585	Fig.3-43
26	26	1881.6	95	14	133	-0.3	828	Fig.3-44
26	26	1880	115	10	186	0	845	Fig.3-44
26	26	1820	75	14	127	0.5	486	Fig.3-45
30	M27	2074	100	12	170	1	801	Fig.3-46
33	33	2264.4	123	18	125	0.5	1941	Fig.3-47
33	33	2272	90	16	139	0.5	900	Fig.3-48
43	33	2444.4	180	18	133	1	2117	Fig.3-49
34	34	2500	90	10	248	0	1643	Fig.3-50
34	34	2415.6	135	18	133	-0.4	1601	Fig.3-51
32	32	2700	130	18	148	0	2395	Fig.3-52
32	32	2700	130	18	148	0	2392	Fig.3-52
32	32	2700	130	18	148	0	2395	Fig.3-52
32	32	2700	130	18	148	0	2395	Fig.3-52
34	33	3108	200	14	220	0	4091	Fig.3-53
34	33	3108	200	14	220	0	4091	Fig.3-53
34	33	3108	200	14	220	0	4091	Fig.3-53
34	33	3108	200	14	220	0	4091	Fig.3-53
34	33	3108	200	14	220	0	4091	Fig.3-53
40	40	3258	190	18	179	0	5407	Fig.3-54
40	40	3325	200	25	131	0	5450	Fig.3-54
40	40	3258	190	18	179	0	5410	Fig.3-54
37	37	3250	200	25	128	0	4597	Fig.3-55
40	40	3258	190	18	179	0	5410	Fig.3-54

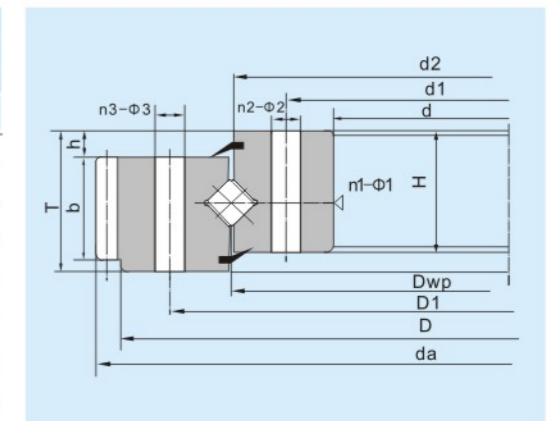



### Cross Cylindrical Roller Slewing Bearing-With External Teeth

d2500~3230mm

Boundary Dimension			Bearing Type	Related Dimension									
d	D	T		D1	d1	d2	H	h	Dwp	n1	n2	n3	φ1
mm			mm										
2500	—	210	1797/2500K5	2990	2630	2818	200	10	2820	6	36	36	M16×1.5
2500	2920	260	1797/2500K6	3060	2622	2949	240	60	2820	36	36	36	ZG1/4
2500	—	210	1797/2500K7	3060	2622	2818	200	10	2820	12	36	36	ZG1/4
2500	—	210	1797/2500K8	2990	2630	2818	200	10	2820	12	36	36	ZG1/4
2500	2920	260	1797/2500K9	3060	2622	2949	240	60	2820	36	36	36	ZG1/4
2500	2920	260	1797/2500K10	3060	2622	2949	240	60	2820	36	36	36	ZG1/4
2500	2920	260	1797/2500K11	3060	2622	2949	240	60	2820	36	36	36	ZG1/4
2500	—	210	1797/2500G2	2990	2630	2818	200	10	2820	12	36	36	M14×1.5
2500	2920	260	1797/2500G2K1	3060	2622	2949	240	60	2820	36	36	36	ZG1/4
2500	2920	260	1797/2500G2K2	3060	2622	2949	240	60	2820	12	36	36	ZG1/4
2500	2920	260	1797/2500G2K3	3060	2622	2949	240	60	2820	36	36	36	ZG1/4
2500	—	210	1797/2500G2K5	2990	2630	2818	200	10	2820	6	36	36	M16×1.5
2500	—	210	1797/2500G2K6	2990	2630	2818	200	10	2820	12	36	36	M14×1.5
2600	—	200	1797/2600	3050	2700	2868	180	20	2870	12	60	60	ZG1/4
2600	—	200	1797/2600G	3050	2700	2868	180	20	2870	6	60	60	M12×1.25
2600	—	200	1797/2600G2	3050	2700	2868	180	20	2870	18	60	60	ZG1/4
2600	—	200	1797/2600G2K	3050	2700	2868	180	20	2870	4	60	60	14
2600	—	200	1797/2600G2K1	3050	2700	2868	180	20	2870	8	60	60	M10×1
2600	—	200	1797/2600G2K3	3050	2700	2868	180	20	2870	12	60	60	ZG1/4
2600	—	200	1797/2600G2K4	3050	2700	2868	180	20	2870	12	60	60	ZG1/4
2600	—	200	1797/2600G2K5	3050	2700	2868	180	20	2870	18	60	60	ZG1/4
2600	—	200	1797/2600G2K6	3050	2700	2868	180	20	2870	10	60	60	M10×1
2625	2978	112	111.40.2800.03	2910	2691	2797.5	100	12	2800	8	56	56	M10×1
2625	2978	112	112.40.2800.12	2910	2691	2797	100	12	2800	8	56	56	M10×1
2625	—	150	112.40.2800.12K	2910	2691	2797	100	12	2800	8	56	56	10
2625	—	150	112.40.2800.12K1	2910	2691	2797	100	12	2800	8	56	56	10
2625	2978	144	112.40.2800.12K2	2910	2691	2797	132	12	2800	8	56	56	M10×1
2625	2978	144	112.40.2800.12K3	2910	2691	2797	132	12	2800	8	56	56	M10×1
2635	3332	270	1797/2635G	3240	2755	2998	240	45	3000	6	36	36	M12×1.25
2635	3332	270	1797/2635G2	3240	2755	2998	240	30	3000	12	36	36	ZG1/4
2635	3440	270	1797/2635	3240	2755	2998	225	45	3000	12	36	36	ZG1/4
2635	3440	270	1797/2635G2K	3240	2755	2998	225	45	3000	12	36	36	ZG1/4
2635	3440	270	1797/2635G2K1	3240	2755	2998	225	45	3000	9	36	36	ZG1/4
2800	3550	240	1797/2800G2	3390	2920	3152	220	20	3155	8	44	44	14
2922	3376	134	111.50.3150.12	3286	3014	3147.5	122	12	3150	8	56	56	M10×1
2922	3376	134	111.50.3150.12K	3286	3014	3147.5	122	12	3150	8	56	56	M10×1
2922	3376	134	112.50.3150.12	3286	3014	3147.5	122	12	3150	8	56	56	M14×1.5
2922	3376	134	112.50.3150.12K	3286	3014	3147.5	122	12	3150	8	56	56	6
2930	3470	210	112.80.3200.12	3380	3020	3197	190	20	3200	8	48	48	M10×1
2930	3470	210	112.80.3200.12K1	3380	3020	3197	190	20	3200	8	48	48	ZG1/4
2930	3470	210	112.80.3200.03	3380	3020	3197	190	20	3200	8	48	48	6
2930	3470	210	112.80.3200.12K	3380	3020	3197	190	20	3200	8	48	48	6
3230	3970	240	1797/3230	3820	3350	3578	220	20	3580	9	54	52	M12×1.25
3230	3970	240	1797/3230G2	3820	3350	3578	220	20	3580	9	54	52	M12×1.25
3230	3970	240	1797/3230G	3820	3350	3578	220	20	3580	9	54	52	M12×1.25
3230	3970	240	1797/3230GY	3820	3380	3578	220	20	3580	4	36	52	M12×1.25
3230	3970	240	1797/3230G2K	3820	3350	3578	220	20	3580	8	54	52	14
3230	4092	240	1797/3230G2K2	3820	3350	3578	220	20	3580	9	54	52	M12×1.25
3230	4080	240	1797/3230G2K3	3820	3350	3578	220	20	3580	9	54	52	M12×1.25
3230	4100	240	1797/3230G2K4	3820	3350	3578	220	20	3580	8	54	52	ZG1/4
3230	4100	240	1797/3230G2K5	3820	3350	3578	220	20	3580	16	54	52	ZG1/4
3230	4100	240	1797/3230G2K6	3820	3380	3578	220	20	3580	4	36	52	M12×1.25
3230	3970	252	1797/3230G2K7	3820	3350	3578	232	32	3580	16	36	52	ZG1/4
3230	3970	240	1797/3230G2K8	3820	3350	3578	220	20	3580	10	54	52	M12×1.25
3230	3970	240	1797/3230G2K9	3820	3350	3578	220	20	3580	10	54	52	ZG1/4
3230	3970	240	1797/3230G2K10	3820	3350	3578	220	20	3580	8	54	52	14
3230	3970	240	1797/3230G2K11	3820	3350	3578	220	20	3580	8	54	52	ZG1/4
3230	3970	240	1797/3230G2K13	3820	3350	3578	220	20	3580	13	54	52	M14×1.5
3230	—	240	1797/3230Y3	3820	3380	3578	220	20	3580	13	36	52	M14×1.5
3230	—	240	1797/3230K4	3820	3380	3578	220	20	3580	18	68	52	M14×1.25
3230	4100	240	1797/3230K5	3820	3350	3578	220	20	3580	4	54	52	M12×1.25
3230	4100	240	1797/3230G2Y	3820	3380	3578	220	20	3580	4	36	52	M12×1.25
3230	4100	240	1797/3230G2Y2	3820	3380	3578	220	20	3580	4	36	52	M12×1.25
3230	4100	240	1797/3230G2Y3	3820	3380	3578	220	20	3580	4	36	52	M14×1.5
3230	4100	240	1797/3230G2Y4	3820	3380	3578	220	20	3580	9	36	52	M14×1.5
3230	4100	240	1797/3230GK4	3820	3380	3578	220	20	3580	18	68	52	M12×1.25
3230	4100	240	1797/3230GK5	3820	3350	3578	220	20	3580	4	54	52	M12×1.25
3230	4100	252	1797/3230GK6	3820	3350	3578	232	30	3580	8	54	52	M12×1.25
3230	4100	240	1797/3230G2Y3K	3820	3380	3578	220	20	3580	4	36	52	M12×1.25

		Gear Parameter						Weight kg ≈	Loading Curve
φ2	φ3	da	b	m	Z	x			
37	37	3250	200	25	128	0	4632	Fig.3-55	
40	40	3258	190	18	179	0	5407	Fig.3-54	
40	40	3258	200	18	179	0	4597	Fig.3-54	
37	37	3250	200	25	128	0	4632	Fig.3-55	
40	40	3258	190	18	179	0	5556	Fig.3-54	
40	40	3258	190	18	179	0	5192	Fig.3-54	
40	40	3258	190	18	179	0	5557	Fig.3-54	
37	37	3250	200	25	128	0	4597	Fig.3-55	
40	40	3258	190	18	179	0	5407	Fig.3-54	
40	40	3258	190	18	179	0	5407	Fig.3-54	
40	40	3258	190	18	179	0	5407	Fig.3-54	
37	37	3250	200	25	128	0	4632	Fig.3-55	
37	37	3250	200	25	128	0	4596	Fig.3-55	
35	35	3232.8	180	20	160	-0.18	3558	Fig.3-57	
35	35	3232.8	180	20	160	-0.18	3936	Fig.3-56	
35	35	3232.8	180	20	160	-0.18	3936	Fig.3-56	
35	35	3232.8	180	20	160	-0.18	3936	Fig.3-56	
35	35	3232.8	180	20	160	-0.18	3558	Fig.3-57	
35	35	3232.8	180	20	160	-0.18	3558	Fig.3-57	
35	35	3232.8	180	20	160	-0.18	3936	Fig.3-56	
35	35	3232.8	180	20	160	-0.18	3936	Fig.3-56	
35	35	3232.8	180	20	160	-0.18	3559	Fig.3-57	
33	33	3078	90	18	168	0.5	1282	Fig.3-58	
33	33	3078	90	20	151	0.5	1280	Fig.3-58	
33	33	3388	150	22	151	0.5	2780	Fig.3-58	
35	35	3384	150	22	151	0.5	2780	Fig.3-58	
33	33	3080	120	20	151	0.5	1741	Fig.3-58	
33	33	3080	120	20	151	0.5	1741	Fig.3-58	
42	42	3440	200	20	170	0	5973	Fig.3-59	
42	42	3440	200	20	170	0	5973	Fig.3-59	
42	42	3440	200	20	170	0	5925	Fig.3-59	
42	42	3440	200	20	170	0	5925	Fig.3-59	
42	42	3440	200	20	170	0	5925	Fig.3-59	
37	37	3680	200	23	158	0	5050	Fig.3-60	
45	45	2476	110	20	171	0.5	2177	Fig.3-61	
45	45	3476	110	20	171	0.5	2177	Fig.3-61	
45	45	3476	110	22	155	0.5	2177	Fig.3-61	
45	45	347							



### Cross Cylindrical Roller Slewing Bearing-With External Teeth

d3230~4272mm

Boundary Dimension			Bearing Type	Related Dimension									
d	D	T		D1	d1	d2	H	h	Dwp	n1	n2	n3	φ1
mm				mm									
3230	4100	240	1797/3230G2Y3K1	3820	3380	3578	220	20	3580	13	36	52	M14×1.5
3322	3776	134	111.52.3550.12	3686	3414	3548	122	12	3550	8	56	56	M10×1
3322	3776	134	111.52.3550.12K	3686	3414	3548	122	12	3550	8	56	56	M10×1
3322	3776	134	112.50.3550.03	3686	3414	3547.5	122	12	3550	8	56	56	M10×1
3322	3776	134	112.50.3550.12	3686	3414	3547	122	12	3550	8	56	56	M10×1
3322	3776	134	112.50.3550.12K	3686	3414	3547	122	12	3550	8	56	56	M10×1
3322	3776	150	112.50.3550.12K1	3686	3414	3548	122	12	3550	8	56	56	M10×1
3760	4220	240	1797/3760G	4160	3840	3996	210	55	4000	4	48	48	M14×1.5
4014	4490	206	1797/4014	4411	4080	4243	178	30	4245.5	10	40	40	M10×1
4250	4940	250	1797/4250G	4840	4350	4598	225	25	4600	9	72	72	M16×1.5
4272	4726	174	112.50.4500.12K	4636	4364	4484	162	12	4487	10	30	30	RP1/4

φ2	φ3	Gear Parameter					Weight	Loading Curve
		da	b	m	Z	x		
							kg ≈	
39	39	4100	220	25	162	0	7673	Fig.3-68
45	45	3880	110	20	191	0.5	2464	Fig.3-70
45	45	3880	110	20	191	0.5	2464	Fig.3-73
45	45	3894	110	22	174	0.5	2465	Fig.3-73
45	45	3889.6	110	22	174	0.5	2465	Fig.3-73
45	45	3889.6	110	22	174	0.5	2465	Fig.3-73
45	45	3894.0	150	22	174	0.5	2484	Fig.3-73
32	32	4326	135	14	307	0	4396	Fig.3-74
30	30	4593	160	22	206	0.5	4812	Fig.3-75
48	48	5082	200	30	168	0	8954	Fig.3-76
33	33	4845	150	25	191	0.5	4366	Fig.3-77

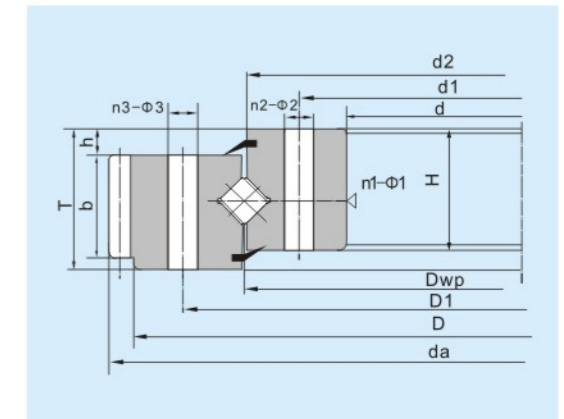



### Cross Cylindrical Roller Slewing Bearing-Without Teeth

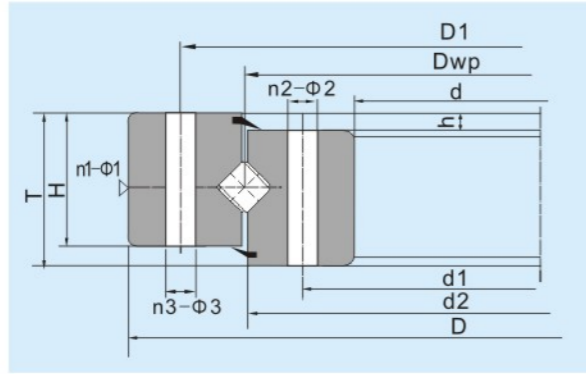

d124.5~1320mm

Boundary Dimension			Bearing Type	Related Dimension										Weight	Loading Curve		
d	D	T		D1	d1	d2	Dwp	H	h	n1	n2	n3	φ1			φ2	φ3
mm			mm													kg ≈	
124.5	234	35	D797/124.5G2	214	143	178	179	30	5	-	16	16	-	3/8(美制)	10	6.53	Fig.3-96
320	550	85	79764	515	365	438	440	75	10	-	8	12	-	18	17	85.6	Fig.3-97
320	550	80	110.20.435.12	500	355	434	436	70	10	2	18	18	M10×1	22	22	75.8	Fig.3-98
400	660	89	79780G2	620	440	529	530	82	7	4	20	20	M10×1	22	22	123	Fig.3-99
480	695	77	110.25.574/P5	640	508	572.5	574	64	13	2	35	36	M10×1	M16	18	87	Fig.3-100
600	900	125	797/600G2	848	690	750	752	105	20	3	29	30	M10×1	M24	26	246	Fig.3-101
670	907	85	797/670	870	730	808	810	80	10	-	8	12	-	18	M16	173	Fig.3-102
678	922	82	110.28.800.04	878	722	798.5	800	72	10	6	30	30	M10×1	22	22	154	Fig.3-103
678	922	82	110.28.800.12	878	722	798.5	800	72	10	6	30	30	M10×1	22	22	154	Fig.3-103
700	1000	140	797/700G	940	770	879	880	130	10	4	24	24	M10×1	22	M20	370	Fig.3-104
845	1150	130	797/845G2	1100	895	1050	1005	105	10	6	24	24	M6	22	22	393	Fig.3-78
870	1090	79	797/870K1	1050	910	978.5	980	72	7	4	44	44	M10×1	22	22	164	Fig.3-79
870	1180	115	797/870G	1125	920	1023	1025	100	15	2	18	18	M8×1	28	28	355	Fig.3-80
870	1180	115	797/870K	1125	920	1023	1025	100	15	2	18	18	M10×1	28	28	355	Fig.3-81
870	1180	115	797/870G2K1	1125	920	1023	1025	100	15	2	18	18	M10×1	28	28	356	Fig.3-80
890	1080	82	797/895G2	1015	922	973	975	70	12	6	30	30	M10×1	M16	M16	139	Fig.3-82
962	1200	90	797/962G2	-	-	1088	1090	76	10	-	-	-	-	-	-	224	Fig.3-83
1000	1270	100	792/1000G2	1220	1050	1132	1135	85	15	4	36	36	M10×1	19	19	303	Fig.3-84
1000	1270	100	792/1000G2K1	1220	1050	1132	1135	85	15	3	36	36	9	19	19	303	Fig.3-84
1000	1270	100	792/1000G2K2	1220	1050	1132	1135	85	15	-	36	36	-	19	19	303	Fig.3-85
1000	1270	100	792/1000G2K5	1220	1050	1132	1135	85	15	2	36	36	20	19	19	304	Fig.3-86
1000	1270	100	792/1000G2K6	1220	1050	1132	1135	85	15	4	36	36	20	19	19	304	Fig.3-87
1060	1400	120	797/1060G2	-	-	1248	1250	120	0	-	-	-	-	-	-	596	Fig.3-122
1060	1400	120	797/1060G2K1	1340	1126	1228	1230	110	10	2	36	36	20	26	26	517	Fig.3-88
1060	1400	120	797/1060G2K2	1340	1126	1228	1230	110	10	4	36	36	20	26	26	517	Fig.3-88
1060	1400	120	797/1060G2K3	1340	1126	1228	1230	110	10	2	36	36	20	26	26	517	Fig.3-88
1060	1400	120	797/1060G2K4	1340	1126	1228	1230	110	10	4	36	36	20	26	26	517	Fig.3-88
1120	1340	70	LY-8010	-	-	1230	1232	70	0	2	-	-	6	-	-	224	Fig.3-123
1200	1520	90	797/1200G2	-	-	1356	1360	90	0	-	-	-	-	-	-	504	Fig.3-124
1250	1608	148	797/1250G2	1512	1297	1403	1405	128	20	4	16	16	M10×1	25	25	743	Fig.3-89
1250	1608	148	797/1250G2K	1512	1297	1403	1405	128	20	4	16	16	M10×1	25	25	717	Fig.3-89
1250	1700	155	792/1250G2	1650	1330	1446	1448	140	10	6	24	24	M10×1	26	26	1103	Fig.3-90
1278	1660	120	797/1278G2K	1535	1335	1428	1430	105	15	4	18	18	M10×1	26	26	589	Fig.3-91
1280	1600	175	792/1280G2	1550	1340	1445	1448	160	15	12	24	24	M12	22	22	758	Fig.3-92
1320	1715	134	797/1320G2	-	-	1503	1506	134	0	-	-	-	-	-	-	958	Fig.3-125
1320	1719	134	D797/1320G2K2	-	-	1532	1534	134	0	8	-	-	12	-	-	967	Fig.3-126

d1320~3116mm

Boundary Dimension			Bearing Type	Related Dimension										Weight	Loading Curve		
d	D	T		D1	d1	d2	Dwp	H	h	n1	n2	n3	φ1			φ2	φ3
mm			mm													kg ≈	
1320	1720	134	797/1320G2K	-	-	1532	1534	134	0	-	-	-	-	-	-	965	Fig.3-127
1320	1720	134	797/1320G2K1	-	-	1532	1534	134	0	-	-	-	-	-	-	965	Fig.3-127
1320	1720	134	797/1320G2K3	-	-	1532	1534	134	0	8	-	-	12	-	-	963	Fig.3-127
1370	1840	160	797/1370G	1770	1430	1598	600	140	10	4	24	30	M10×1	28	28	1213	Fig.3-93
1380	1700	145	797/1380G2	1650	1440	1574	1533	140	5	6	24	24	M10×1	27	27	746	Fig.3-94
1380	1700	145	797/1380G2K	1620	1440	1574	1533	118	5	6	24	24	M10×1	27	27	746	Fig.3-94
1412	1680	170	3-944G2	-	1460	1544	1546	170	25	2	24	-	M10×1	18	-	725	Fig.3-95
1412	1680	170	3-944G2K	-	1460	1544	1546	170	25	2	24	-	M10×1	18	-	723	Fig.3-105
1412	1680	185	3-944G2K1	-	1460	1544	1546	170	40	2	24	-	M12×1.25	18	-	759	Fig.3-105
1412	1680	170	3-944G2K2	1618	1470	1549	1551	170	25	4	20	14	M10×1	M20	M10	693	Fig.3-106
1600	2140	145	797/1600G	1940	1710	1828	1830	135	10	4	48	48	M10×1	26	26	1357	Fig.3-107
1776	2210	150	797/1776G2	2105	1840	1968	1970	135	15	4	36	36	M10×1	26	26	1244	Fig.3-108
1776	2210	150	797/1776G2K	2105	1840	1968	1970	135	15	4	36	36	M10×1	26	26	1244	Fig.3-108
1825	2178	112	110.40.2000.12	2110	1891	1991	1993	100	12	8	48	48	M10×1	33	33	900	Fig.3-109
1825	2178	112	110.40.2000.03K	2110	1891	1991	1993	100	12	8	24	24	M10×1	26	M24	806	Fig.3-110
1860	2320	151	797/1860G2	2245	1980	2113	2115	141	1	6	42	42	M10×1	33	33	1772	Fig.3-111
1860	2320	151	797/1860G2K	2245	1980	2113	2115	141	1	20	42	42	M14×1.5	33	33	1772	Fig.3-111
1860	2320	151	LY-8009	2245	1980	2113	2115	141	1	6	42	42	M12	33	33	1771	Fig.3-111
1916	2320	150	797/1916G2	2245	1980	2113	2115	130	15	3	42	42	M10×1	34	34	1214	Fig.3-111
2065	2418	112	110.40.2240.12K	2350	2131	2237.5	2240	100	12	9	18	18	M10×1	26	M24	929	Fig.3-112
2190	2860	300	797/2190G	2800	2270	2530	2540	260	40	12	36	36	8	32	32	4797	Fig.3-113
2325	2678	112	110.40.2500.12	2610	2391	2498.5	2500	100	12	8	56	56	M10×1	33	33	876	Fig.3-114
2325	2678	112	110.40.2500.12K	2610	2391	2497.5	2500	100	12	8	56	56	M16×1.5	33	33	876	Fig.3-115
2500	2980	180	797/2500G2	2910	2590	2739	2741	170	10	6	48	48	M16×1.5	33	33	2913	Fig.3-116
2500	2980	180	797/2500G2K	2910	2590	2739	2741	170	10	6	48	48	M10×1	33	33	2913	Fig.3-116
2500	2980	180	797/2500G2K1	2910	2590	2739	2741	170	10	3	48	48	M16×1.5	34	34	2913	Fig.3-116
2625	2978	130	110.40.2800.11K	2910	2691	2798	2800	118	30	8	16	16	M10×1	33	33	1287	Fig.3-117
2800	3310	190	792/2800G	3220	2890	3050	3055	165	25	2	60	60	M10×1	39	39	2864	Fig.3-118
2992	3628	216	D797/2992	3472	3092	3289.5	3292	194	16	6	72	72	M10×1	33	33	4747	Fig.3-119
2922	3376	134	110.50.3150.03K	3286	3014	3147.5	3150	122	12	9	56	56	M10×1	33	33	1987	Fig.3-120
3116	3494	150	110.40.3300.03	3428	3182	3298	3300	140	28	14	56	56	M10×1	33	33	1864	Fig.3-121



**Loading Curve**

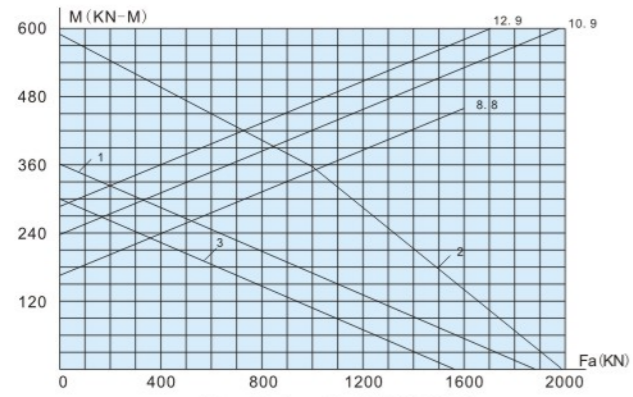

Fig. 3-1 2797/695G2

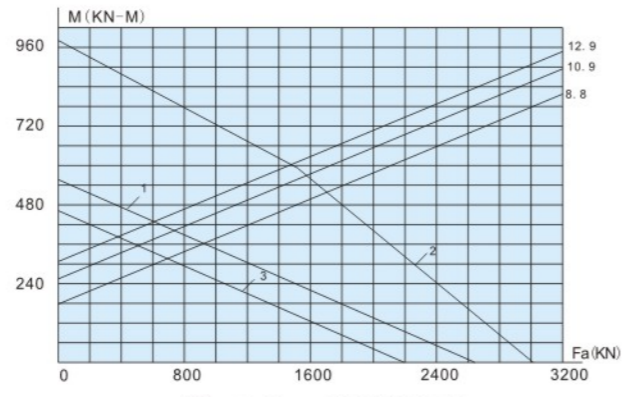

Fig. 3-2 2797/760G2

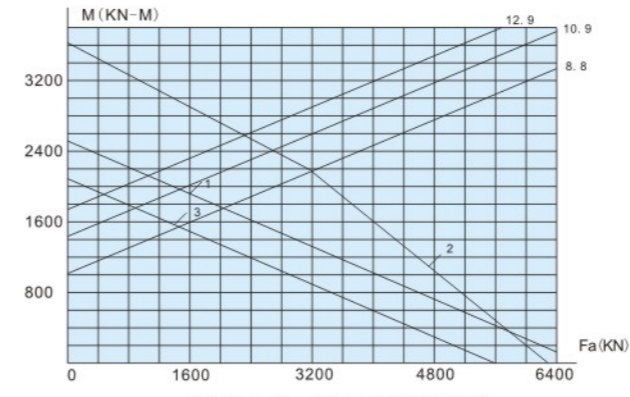

Fig. 3-9 2792/1400G2K

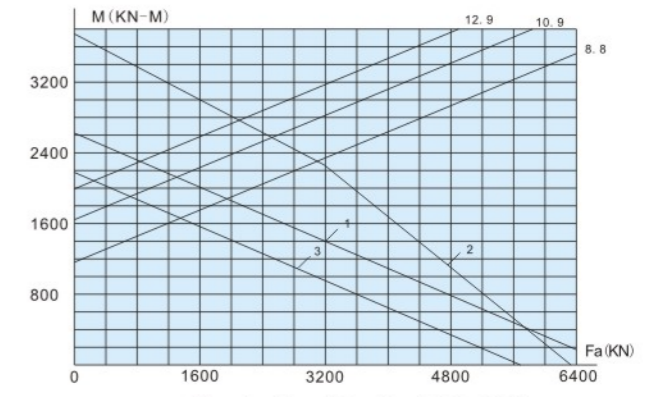

Fig. 3-10 113.40.1600.03K

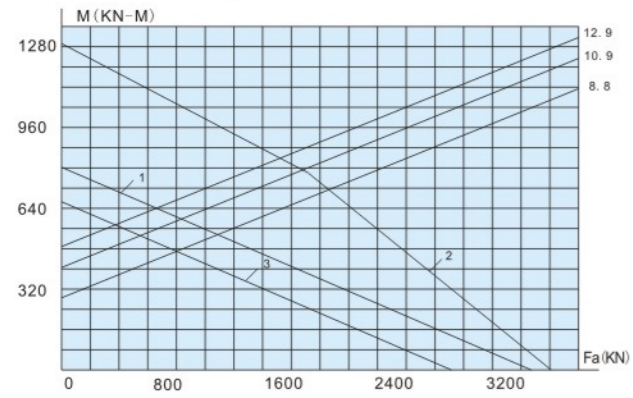

Fig. 3-3 2798/870G2

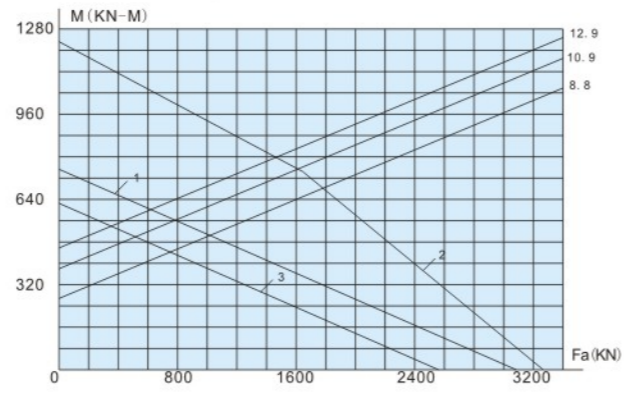

Fig. 3-4 2797/875G2

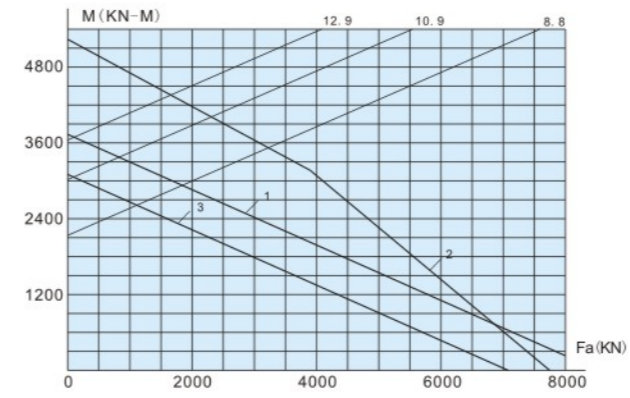

Fig. 3-11 113.45.1830.11

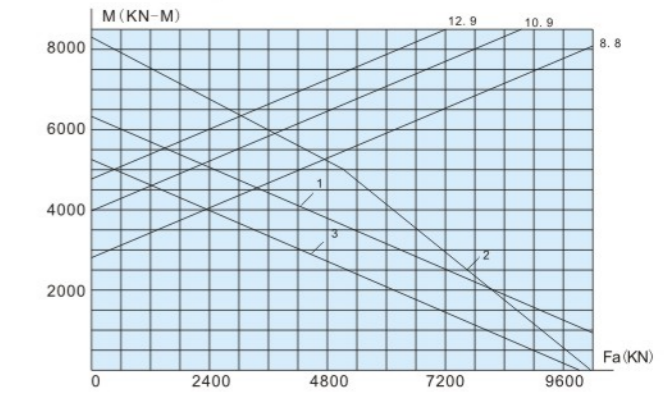

Fig. 3-12 2792/2000G2

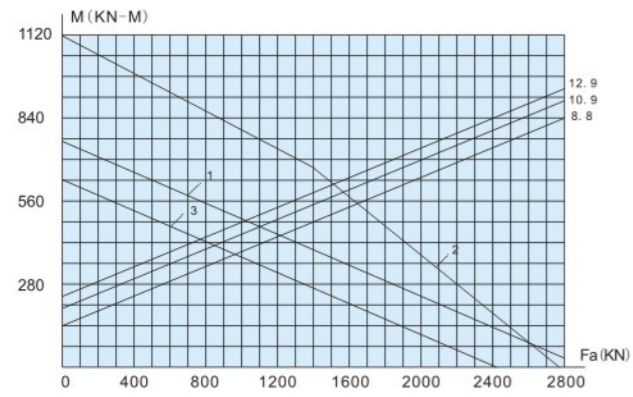

Fig. 3-5 2797/955G

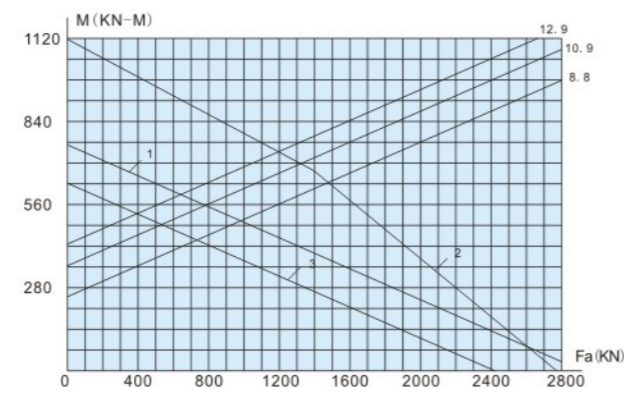

Fig. 3-6 2797/1010G2

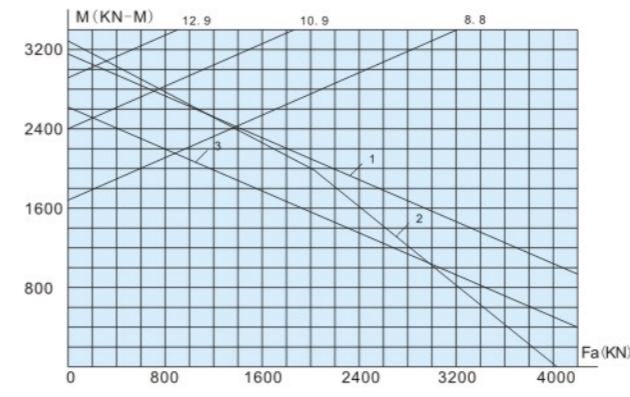

Fig. 3-13 2797/2032

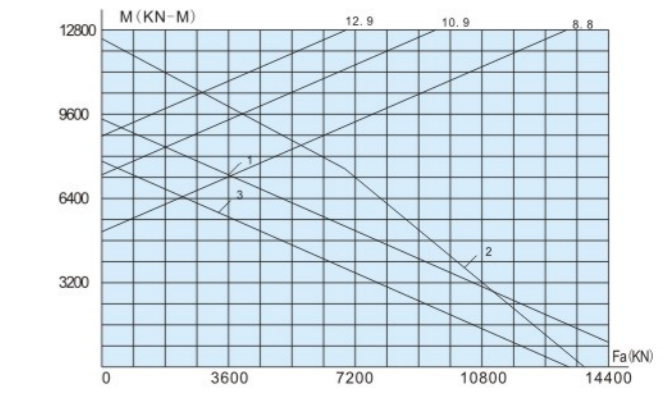

Fig. 3-14 2792/2240G

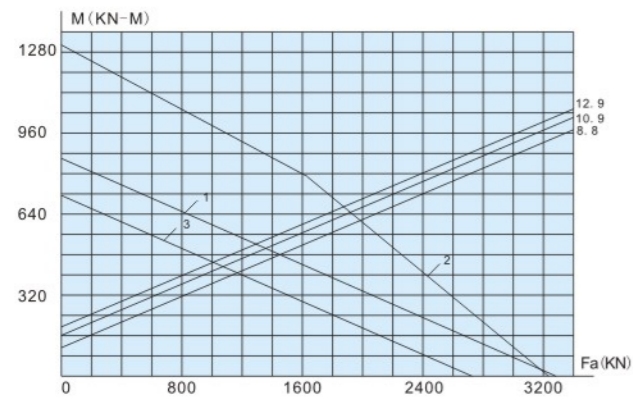

Fig. 3-7 113.28.1094.03

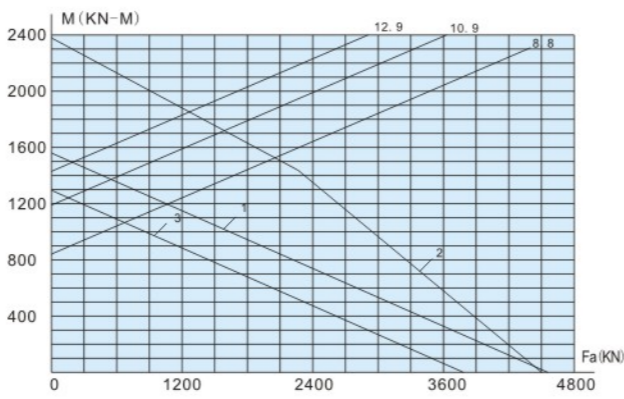

Fig. 3-8 2797/1278G2

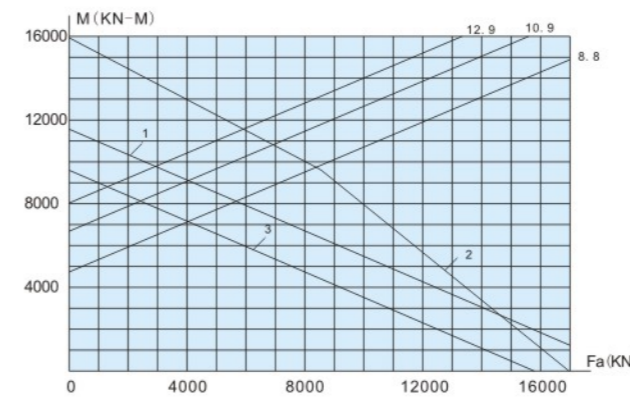

Fig. 3-15 3-940G

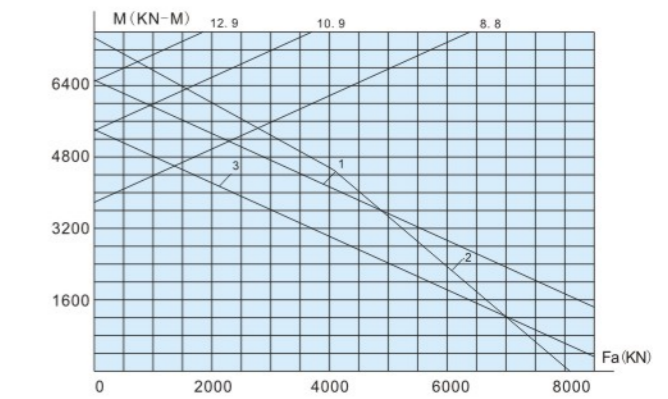

Fig. 3-16 D2797/2325



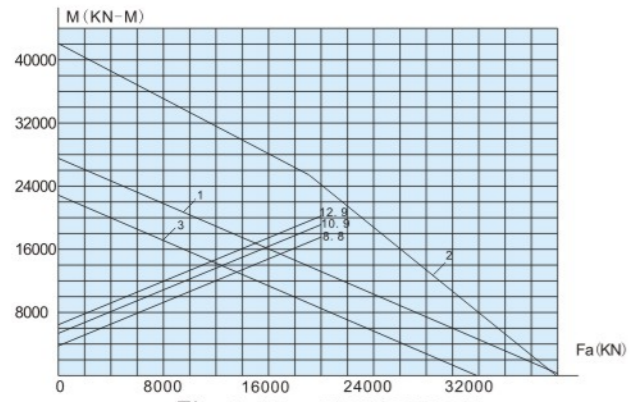

Fig. 3-17 2797/2680GY

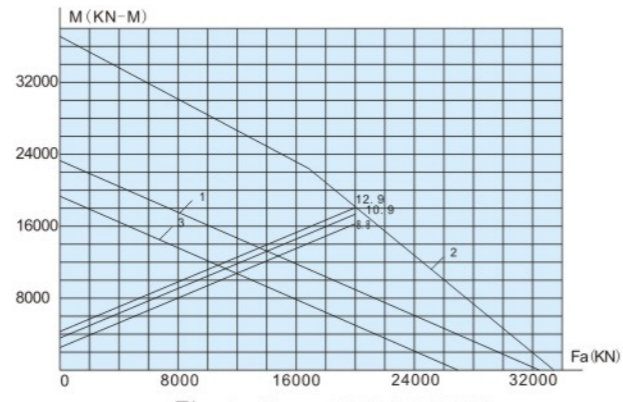

Fig. 3-18 2797/2680GK

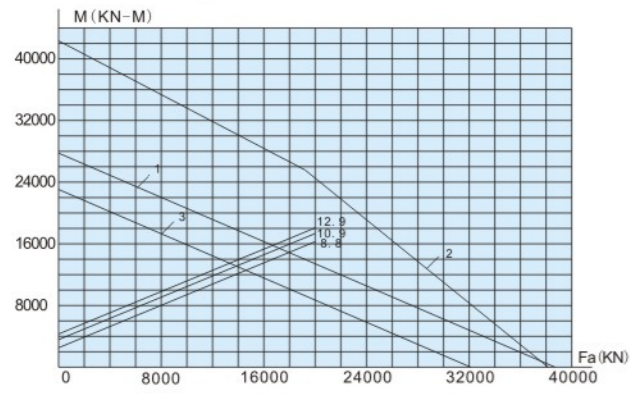

Fig. 3-19 2797/2680G

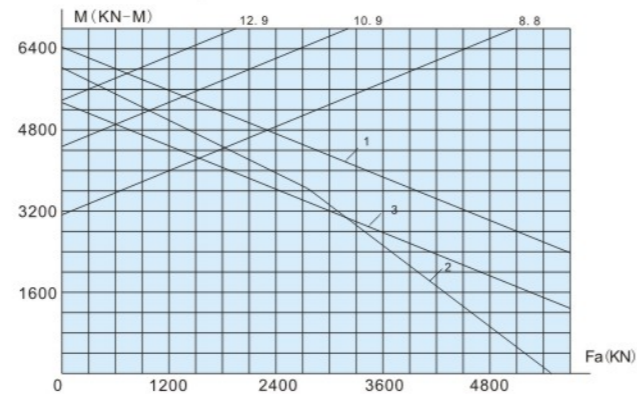

Fig. 3-20 2797/2768

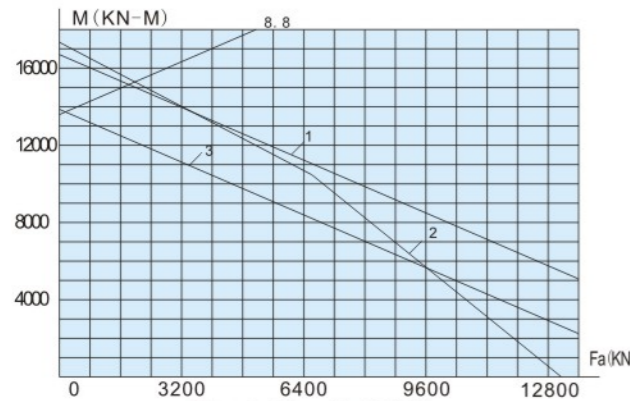

Fig. 3-21 3-943G2

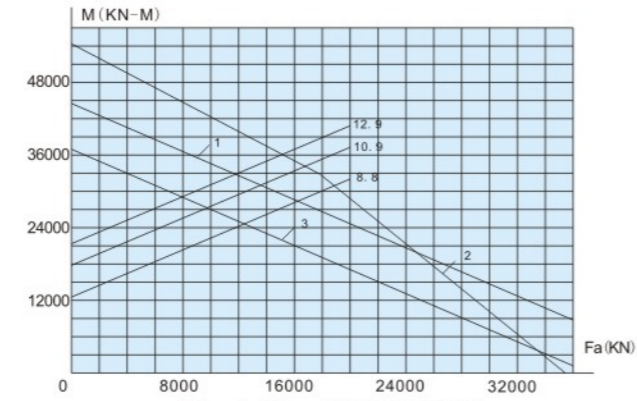

Fig. 3-22 2797/3780G2

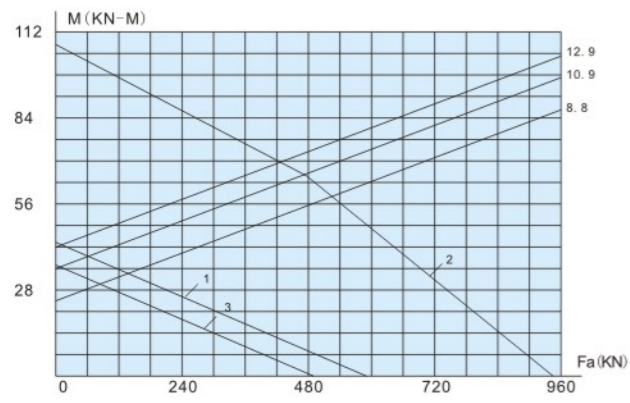

Fig. 3-23 1797/235

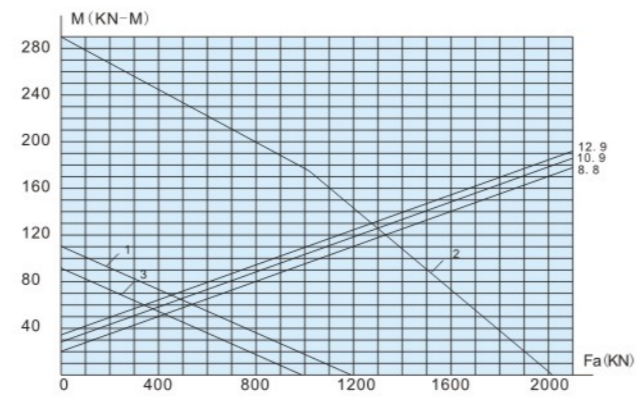

Fig. 3-24 179254G2

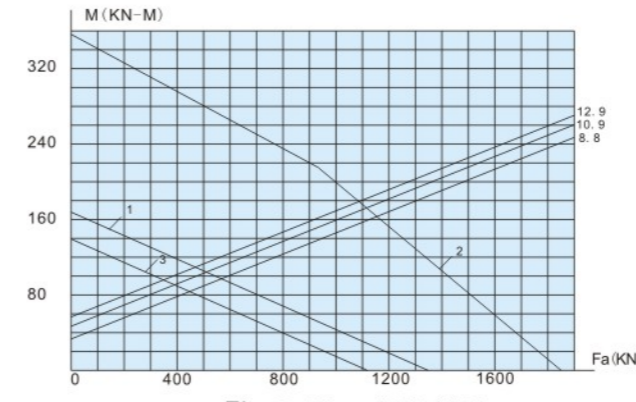

Fig. 3-25 1797/400

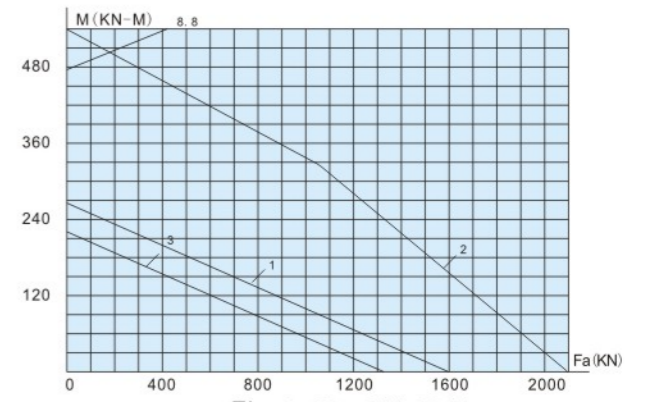

Fig. 3-26 LY-8013

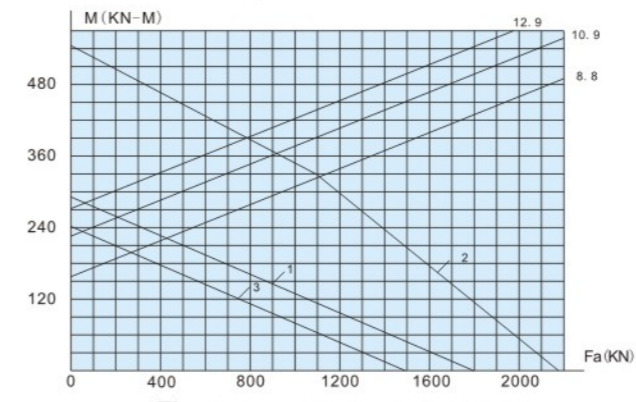

Fig. 3-27 111.25.675.03K/P6

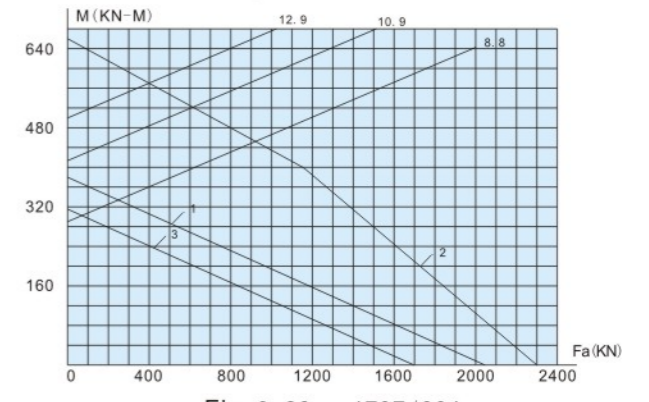

Fig. 3-28 1797/664

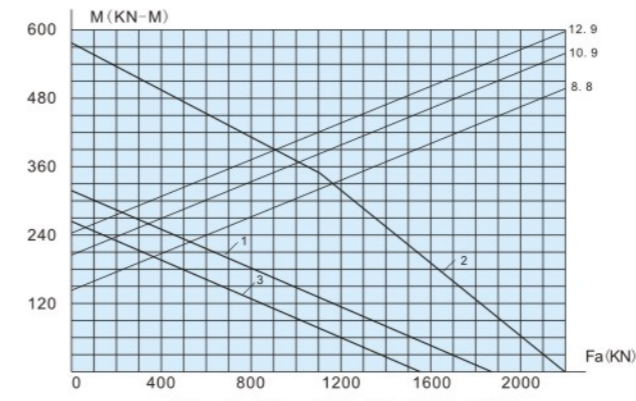

Fig. 3-29 111.25.710.12K

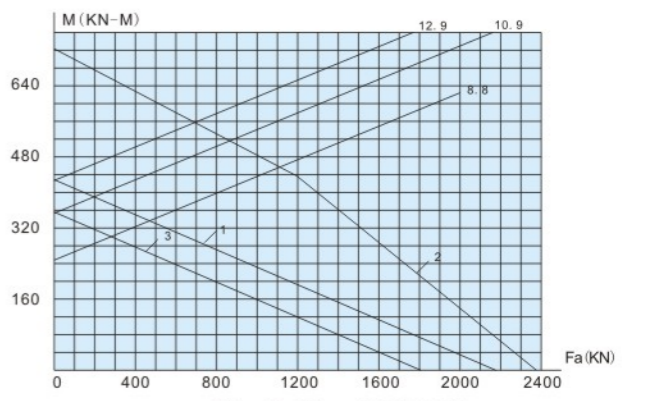

Fig. 3-30 1797/715

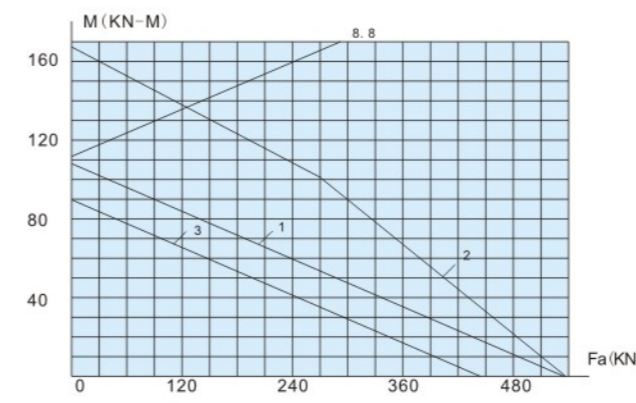

Fig. 3-31 D1797/736G2

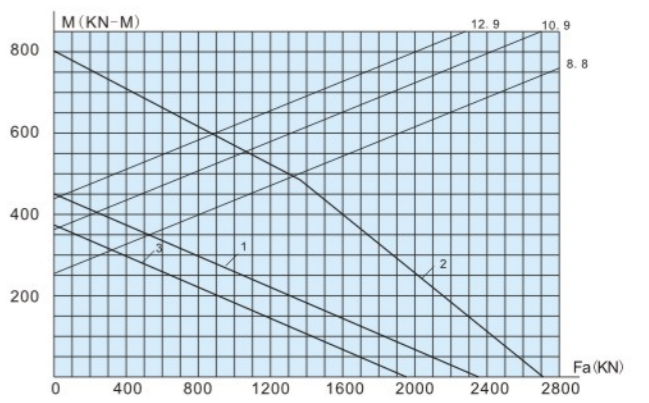

Fig. 3-32 111.28.800.12



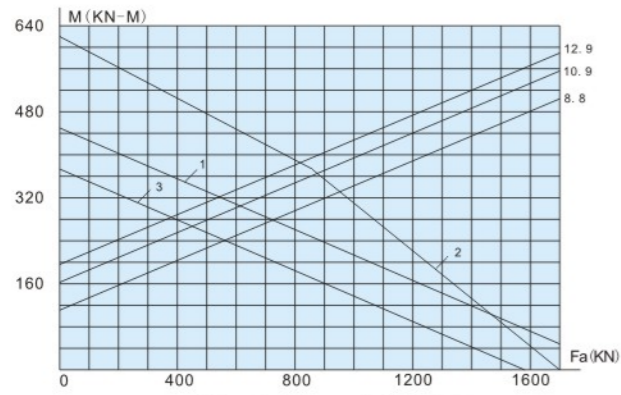

Fig. 3-33 1792/885

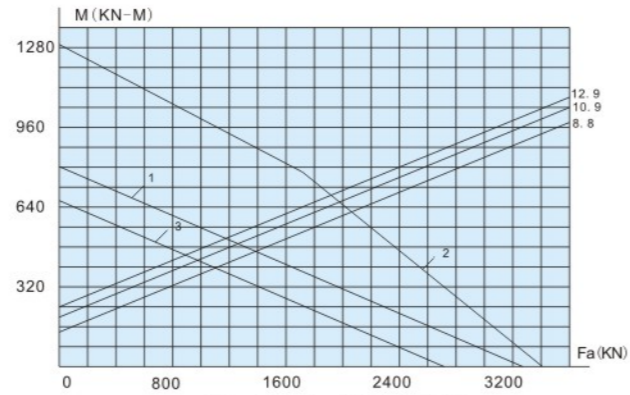

Fig. 3-34 1797/885G

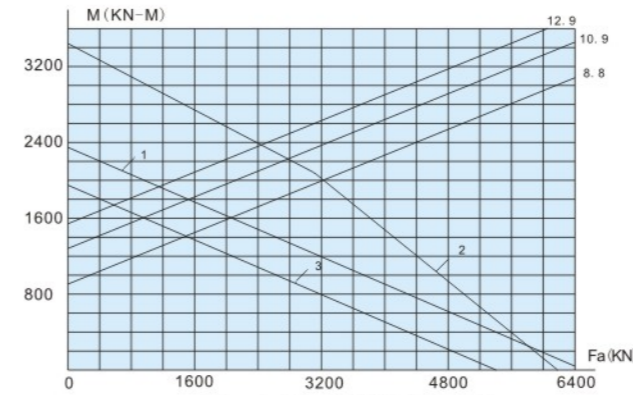

Fig. 3-41 1797/1300G2

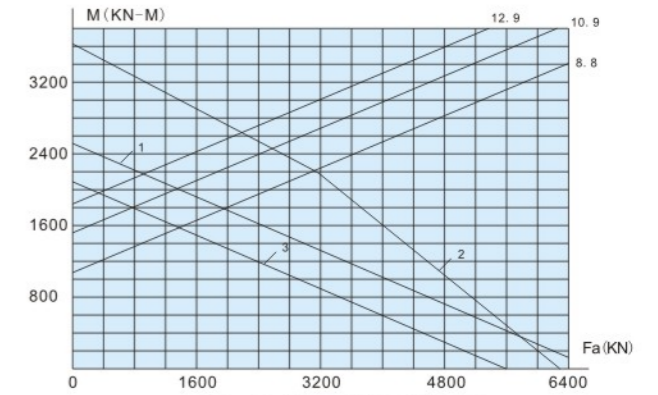

Fig. 3-42 1792/1400G

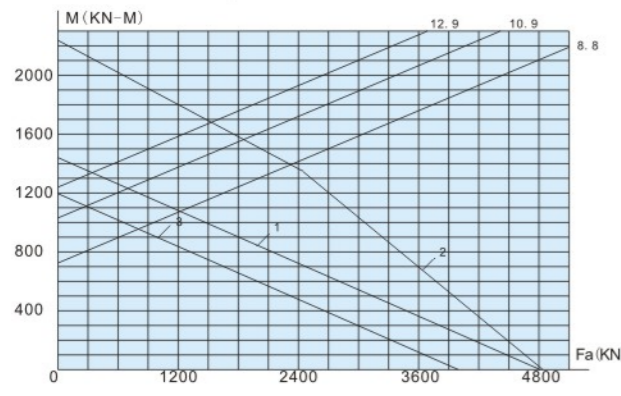

Fig. 3-35 112.36.1250.03

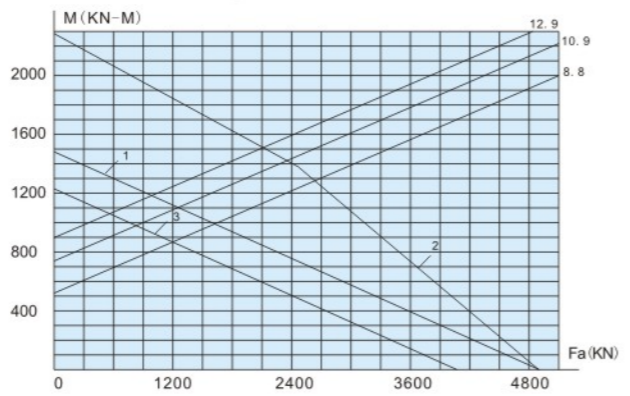

Fig. 3-36 1798/1100G2

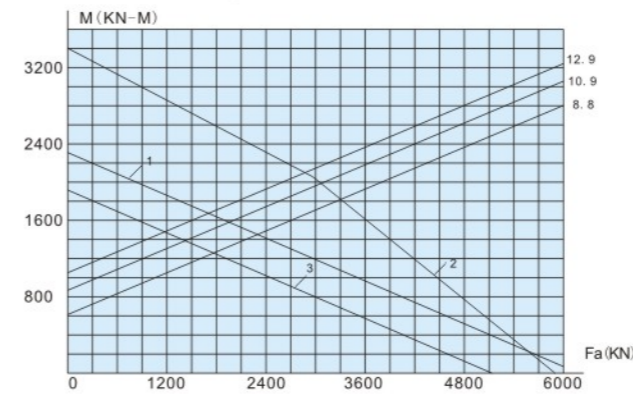

Fig. 3-43 E1792/1400G2K2

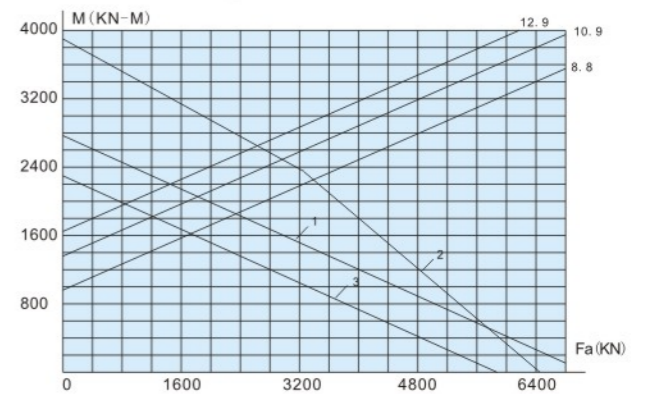

Fig. 3-44 1797/1460G2

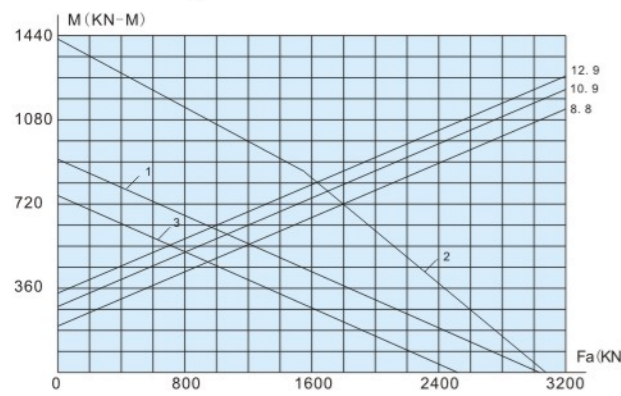

Fig. 3-37 1797/1100G

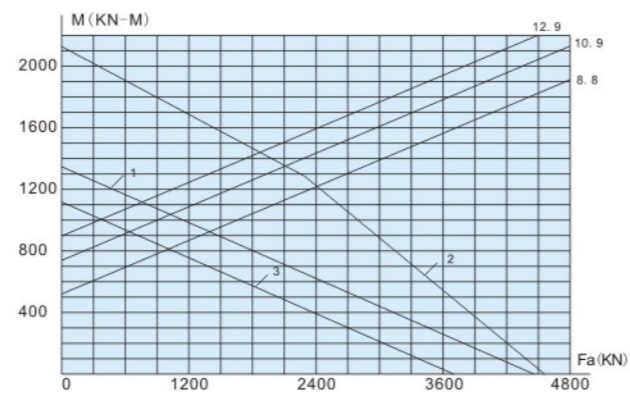

Fig. 3-38 1798/1100G2K1/P5

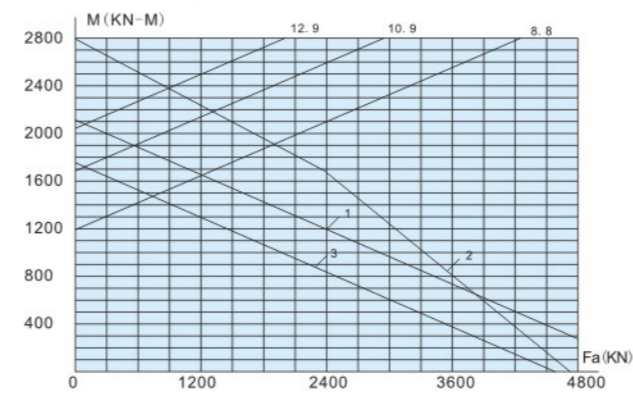

Fig. 3-45 111.32.1600.04

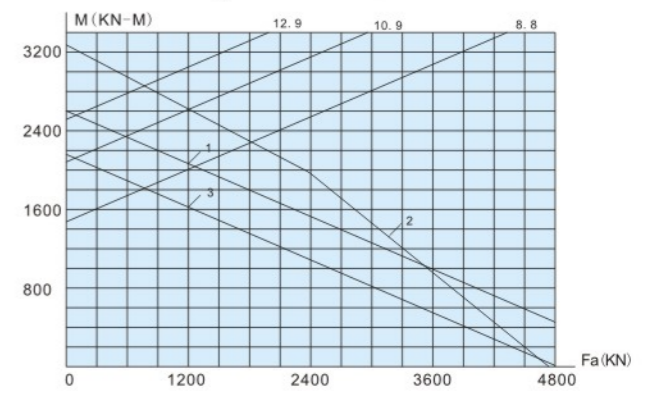

Fig. 3-46 1797/1722

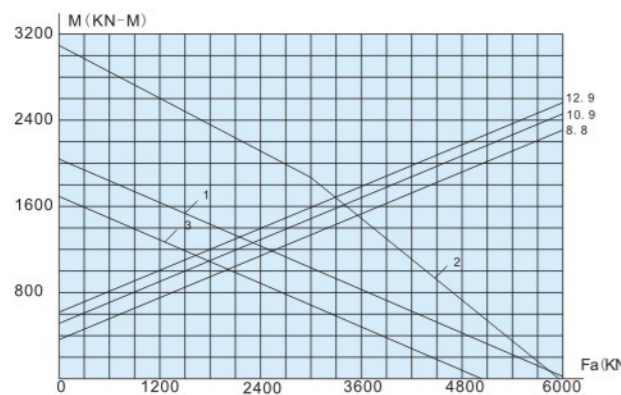

Fig. 3-39 1797/1250G2

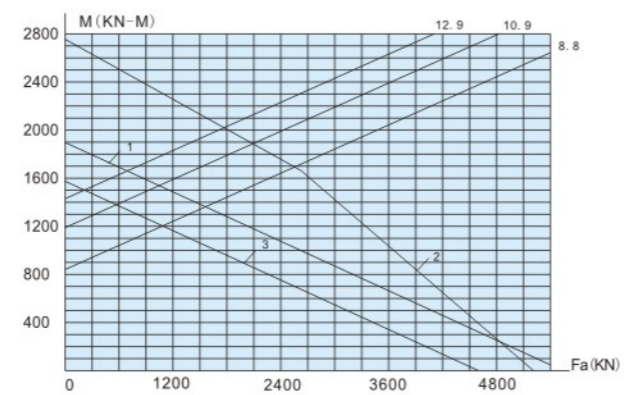

Fig. 3-40 1797/1278G2

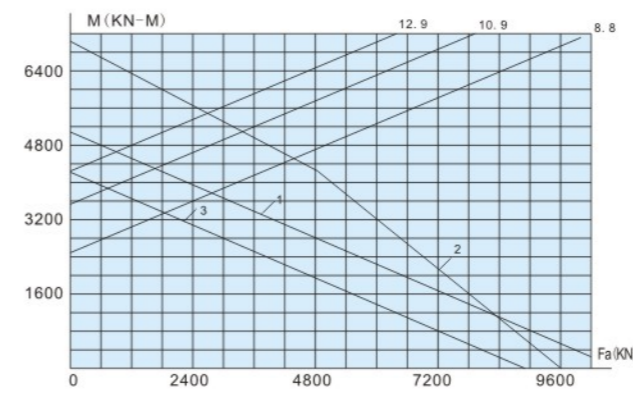

Fig. 3-47 1797/1785

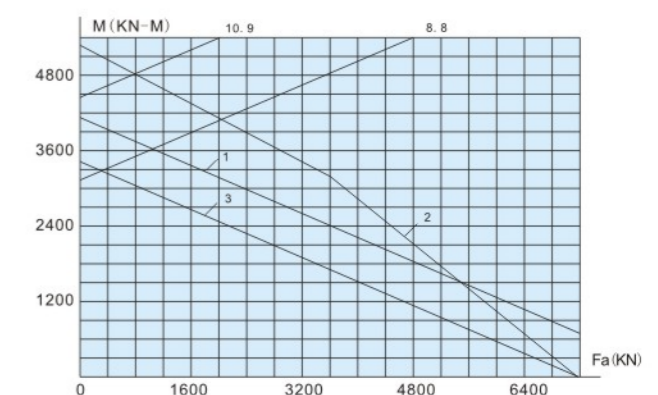

Fig. 3-48 111.40.2000.11



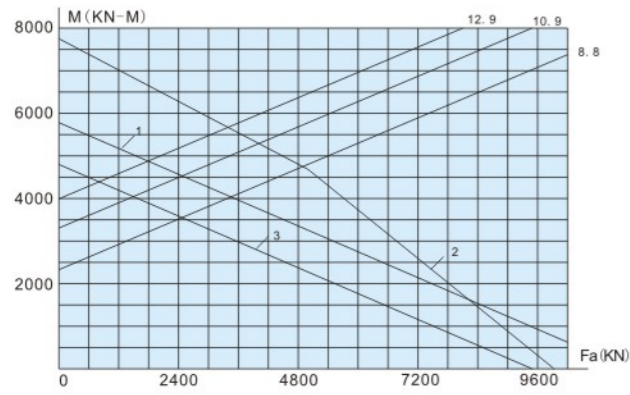

Fig. 3-49 1797/1914

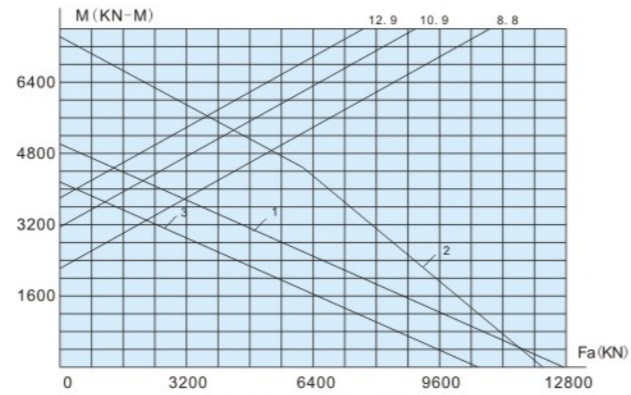

Fig. 3-50 1797/1915G2

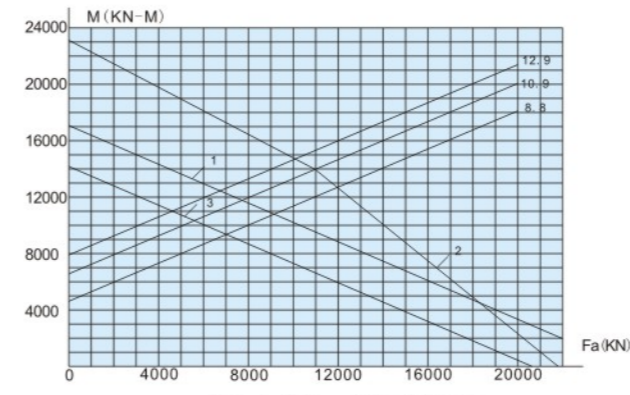

Fig. 3-57 1797/2600

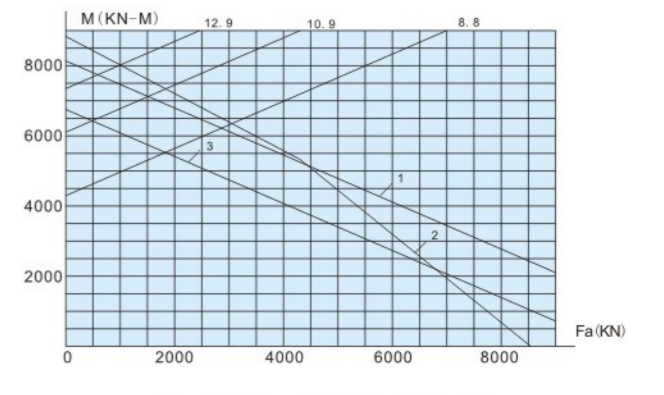

Fig. 3-58 111.40.2800.03

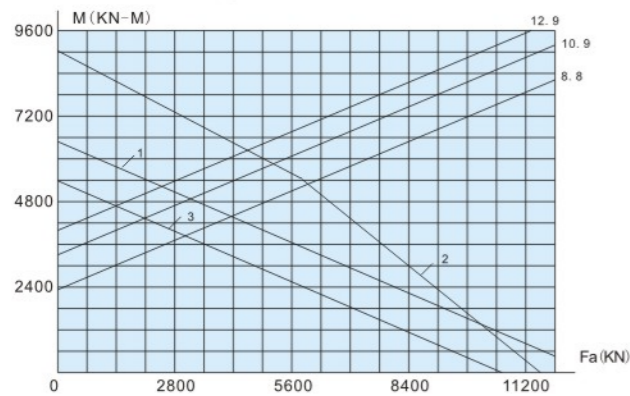

Fig. 3-51 1797/1916G2

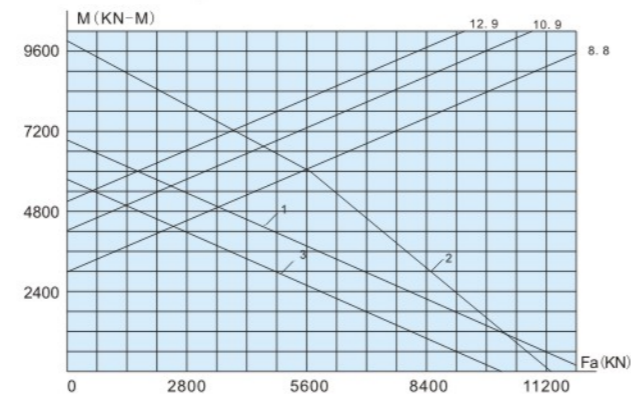

Fig. 3-52 1797/2100G2

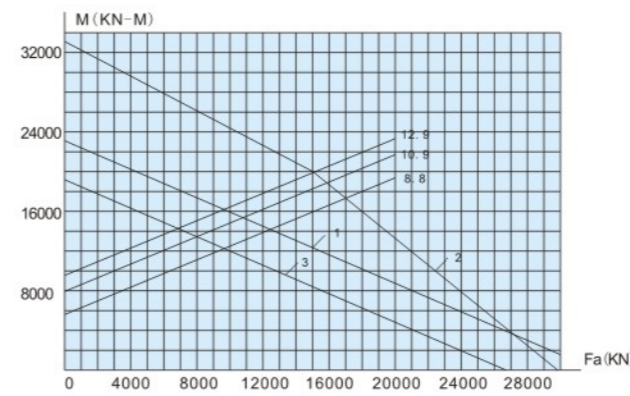

Fig. 3-59 1797/2635G

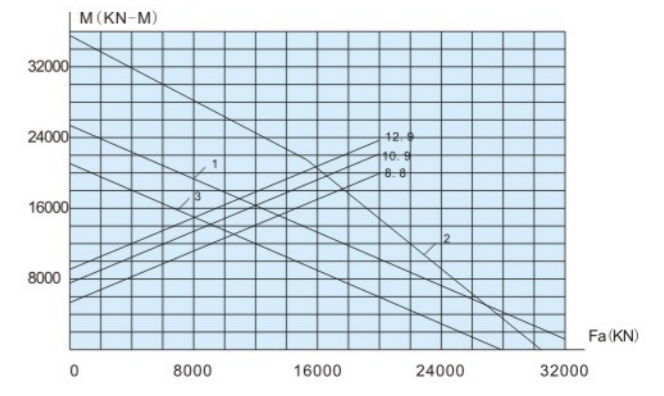

Fig. 3-60 1797/2800G2

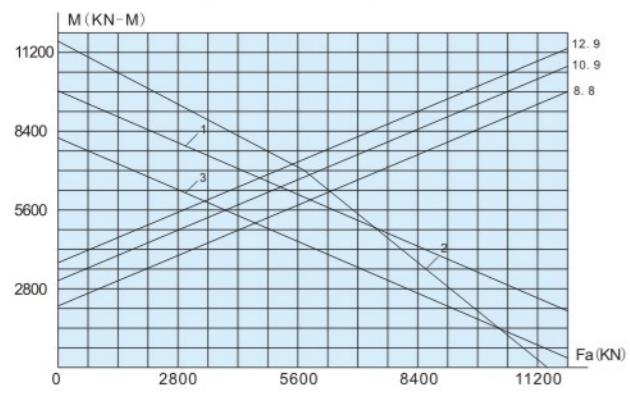

Fig. 3-53 1797/2460G2

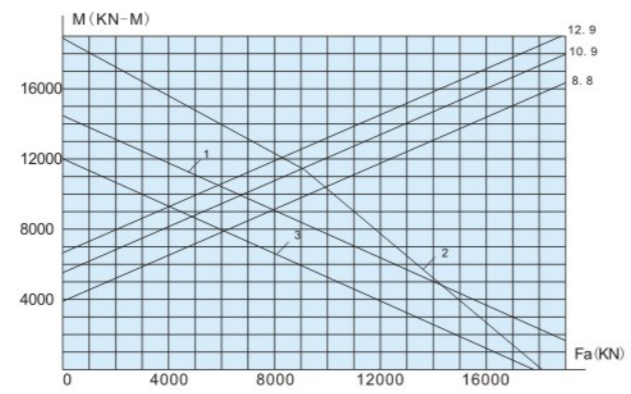

Fig. 3-54 1797/2500K

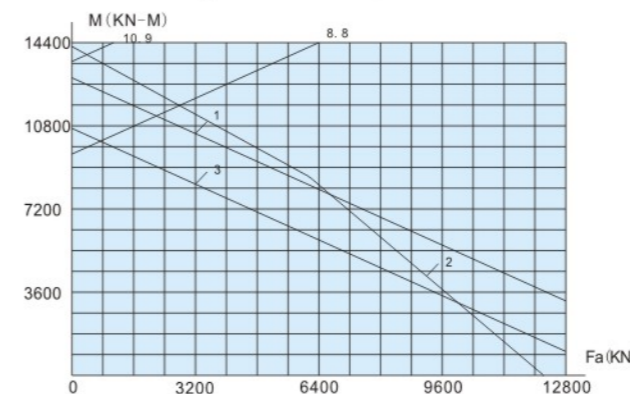

Fig. 3-61 111.50.3150.12

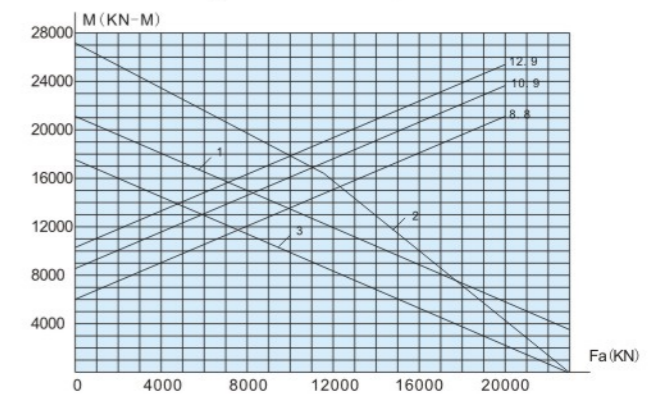

Fig. 3-62 112.80.3200.12

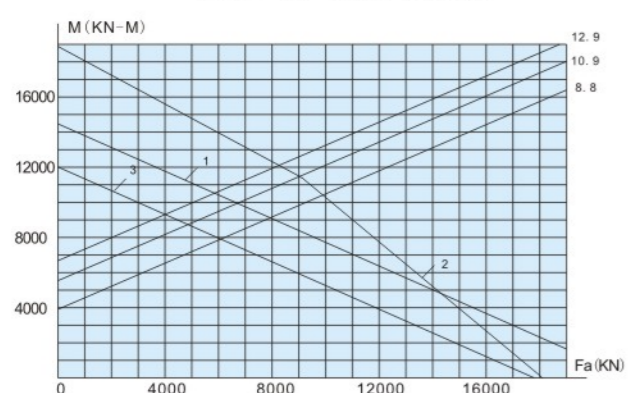

Fig. 3-55 1797/2500K3

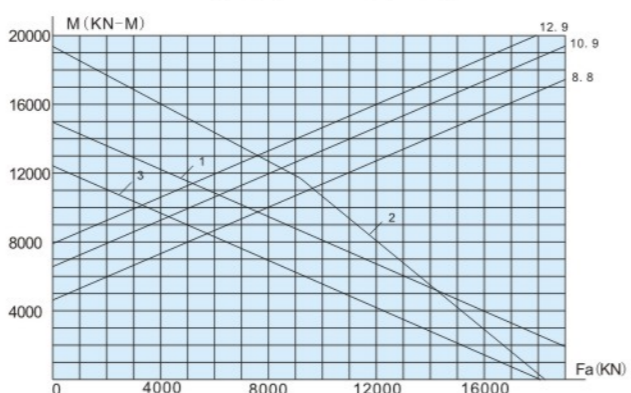

Fig. 3-56 1797/2600G

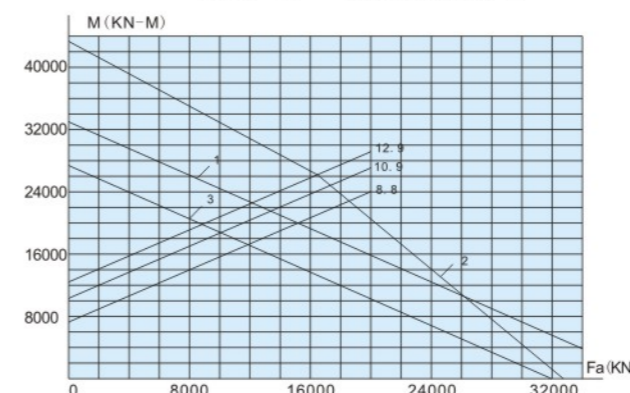

Fig. 3-63 1797/3230

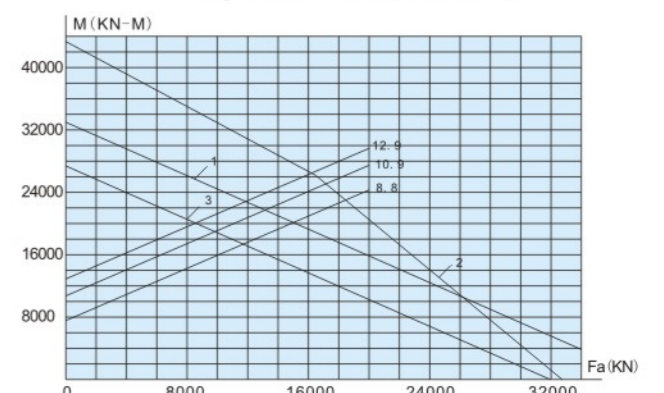

Fig. 3-64 1797/3230G



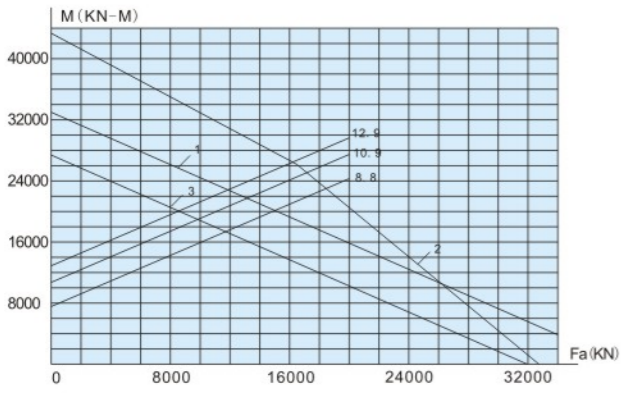

Fig. 3-65 1797/3230G2K11

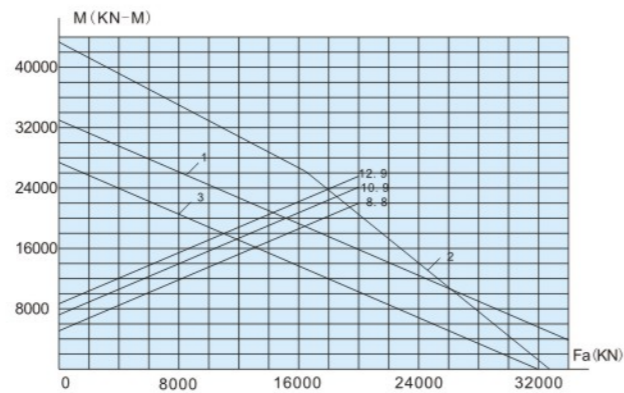

Fig. 3-66 1797/3230GY

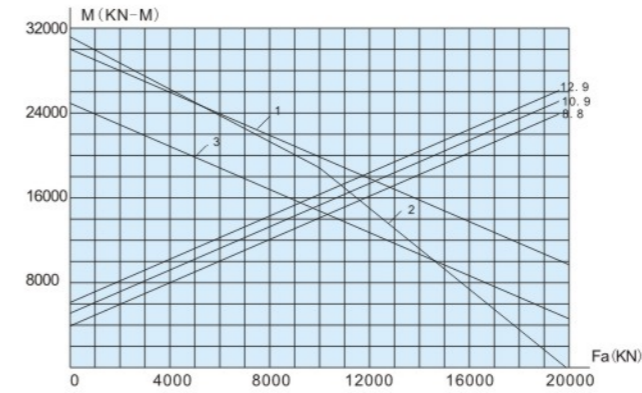

Fig. 3-75 1797/4014

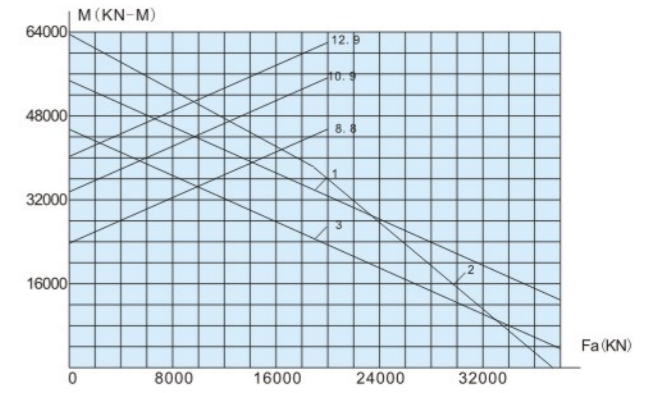

Fig. 3-76 1797/4250G

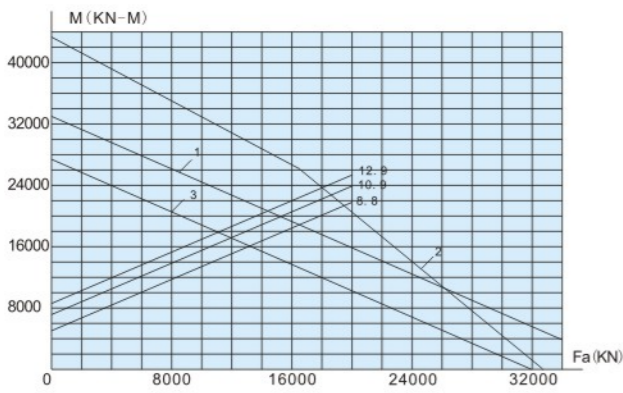

Fig. 3-67 1797/3230G2K7

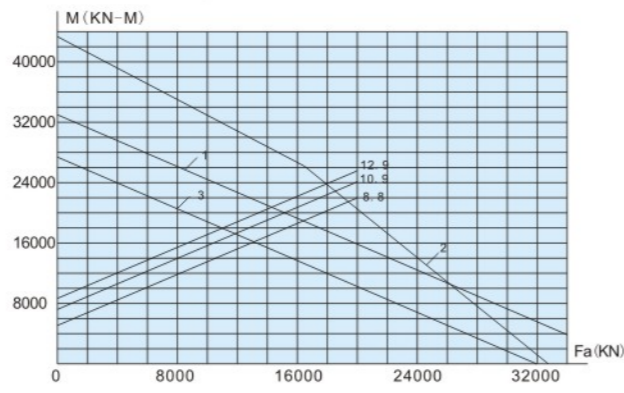

Fig. 3-68 1797/3230G2Y3K1

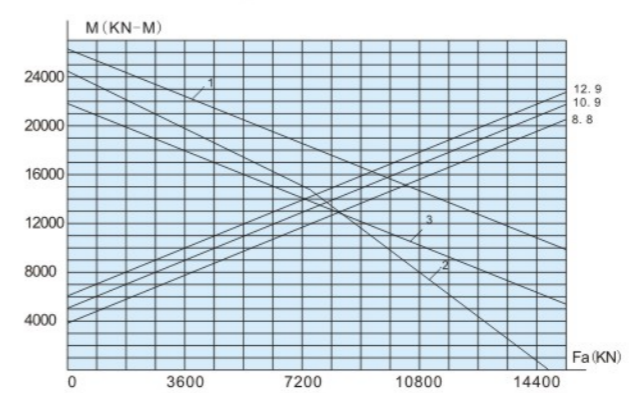

Fig. 3-77 112.50.4500.12K

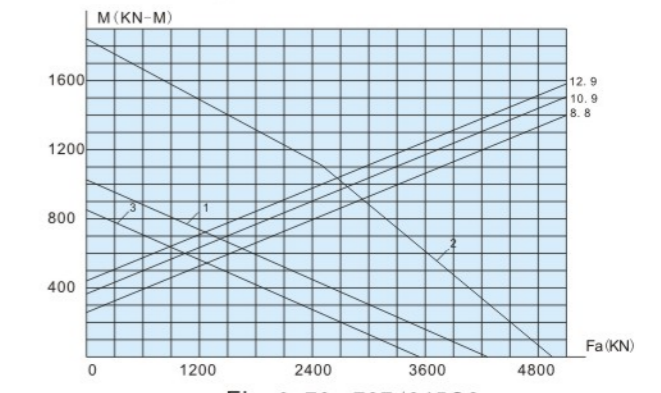

Fig. 3-78 797/845G2

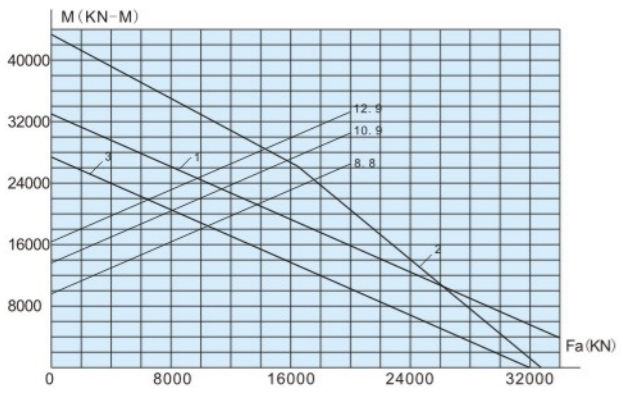

Fig. 3-69 1797/3230K4

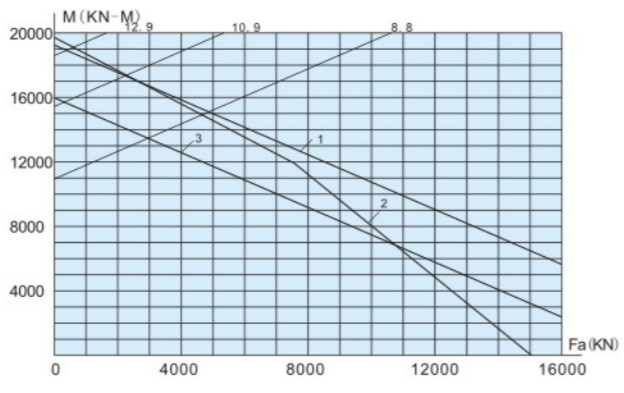

Fig. 3-70 111.52.3550.12

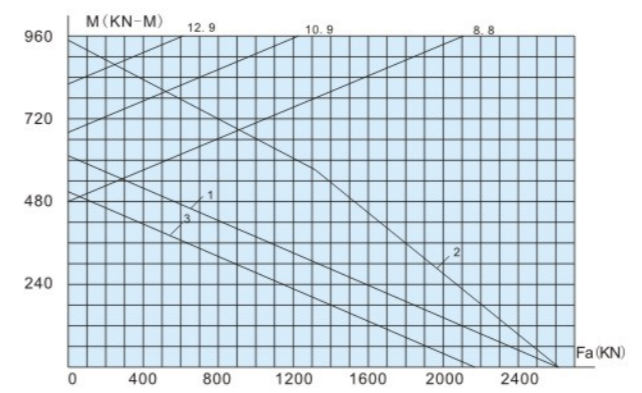

Fig. 3-79 797/870K1

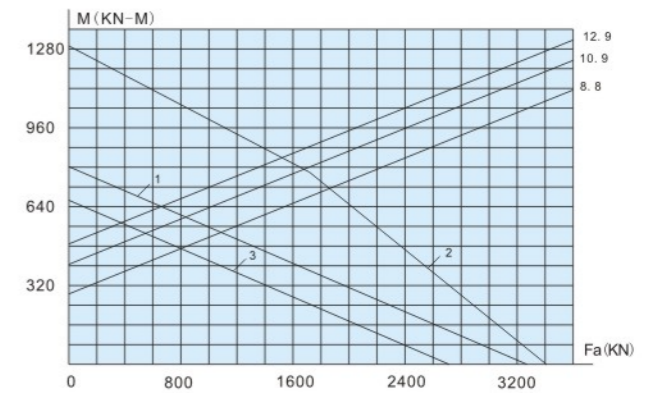

Fig. 3-80 797/870G

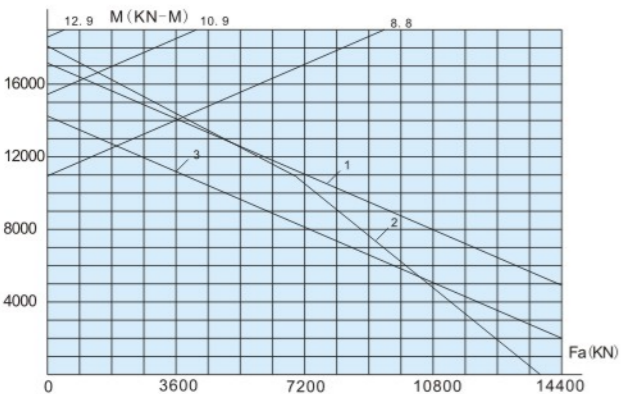

Fig. 3-71/3-72/3-73 112.50.3550.03

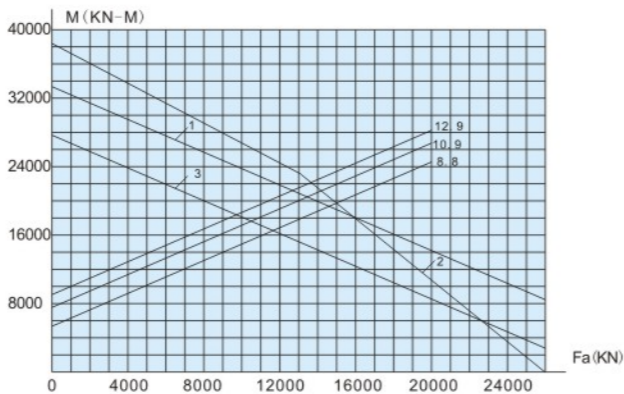

Fig. 3-74 1797/3760G

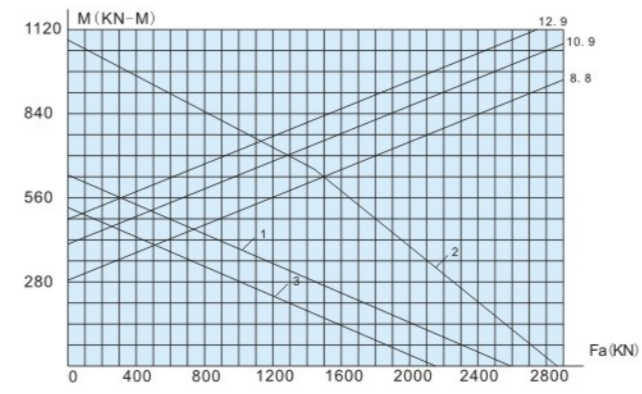

Fig. 3-81 797/870K

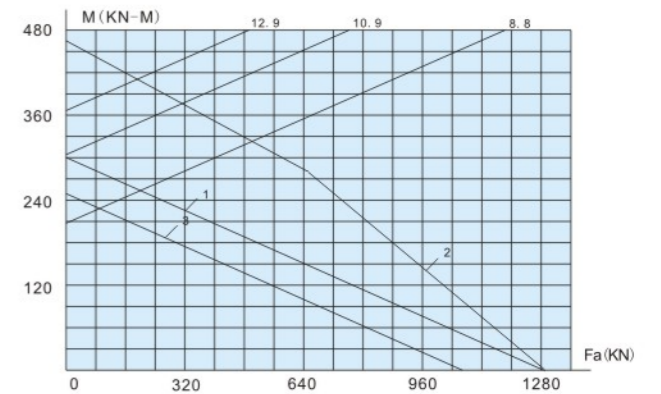

Fig. 3-82 797/895G2



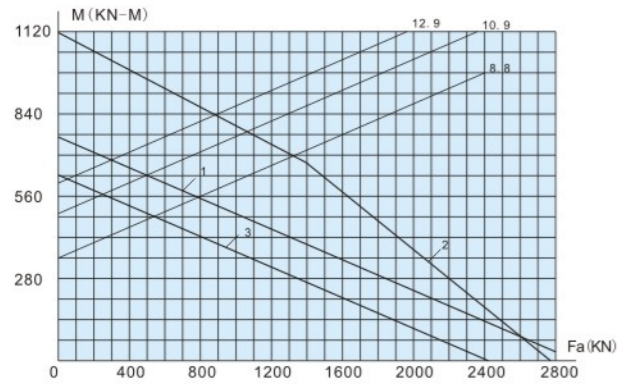

Fig. 3-83 797/962G2

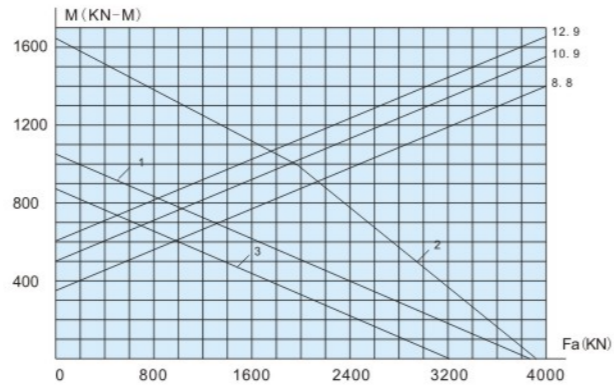

Fig. 3-84 792/1000G2

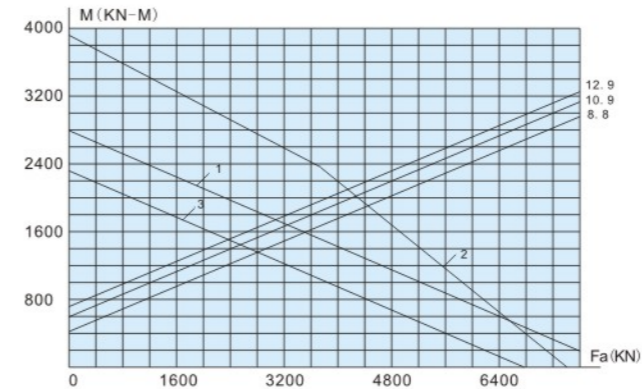

Fig. 3-91 797/1278G2K

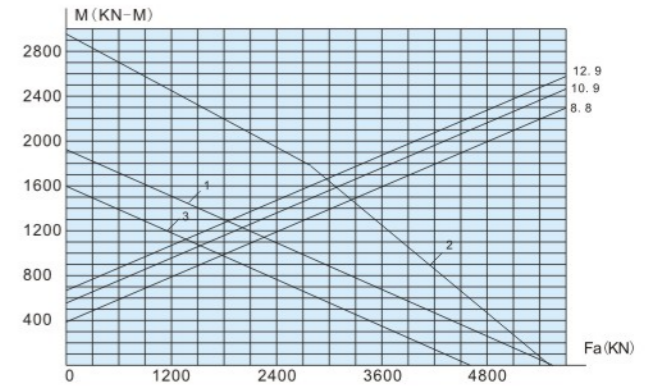

Fig. 3-92 792/1280G2

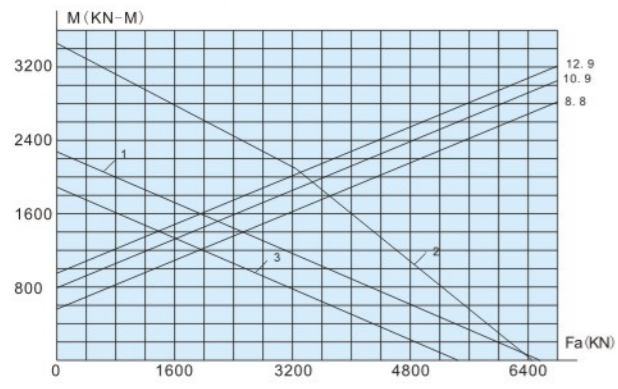

Fig. 3-85 792/1000G2K1

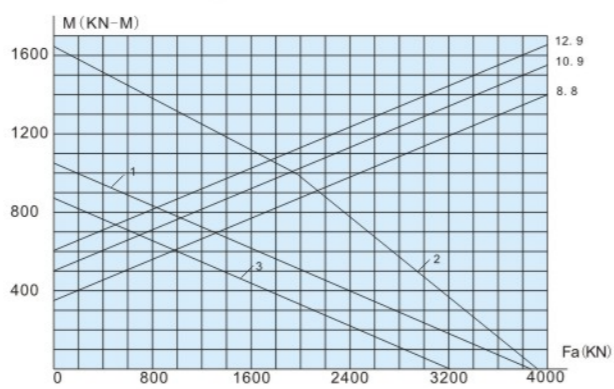

Fig. 3-86 792/1000G2K2

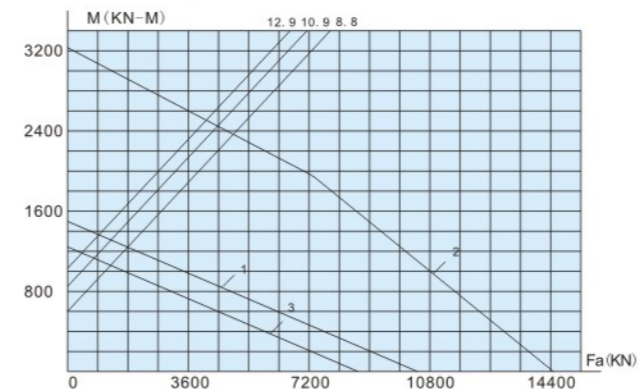

Fig. 3-93 797/1370G

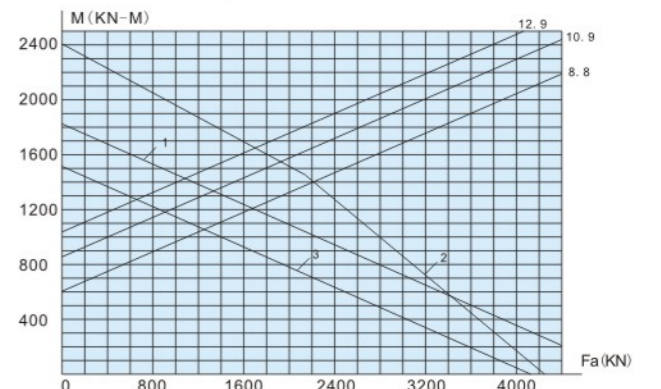

Fig. 3-94 797/1380G2

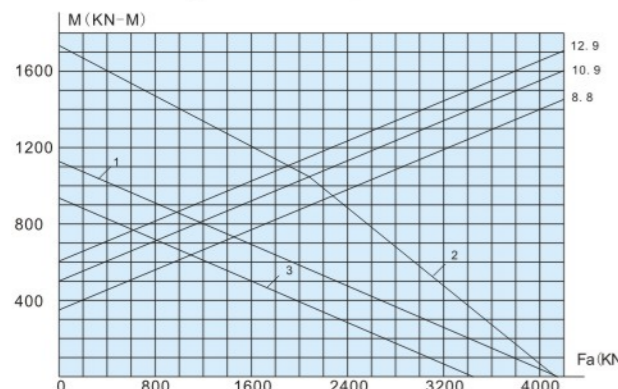

Fig. 3-87 792/1000G2K6

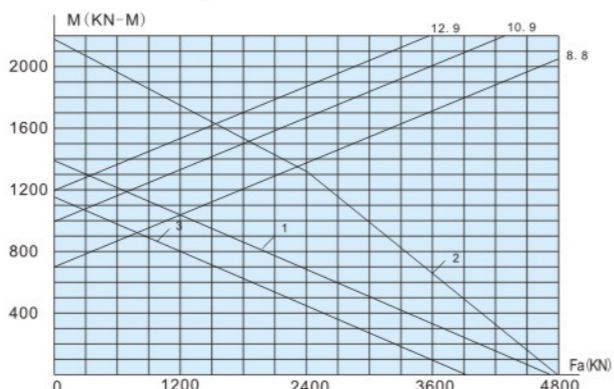

Fig. 3-88 797/1060G2K1

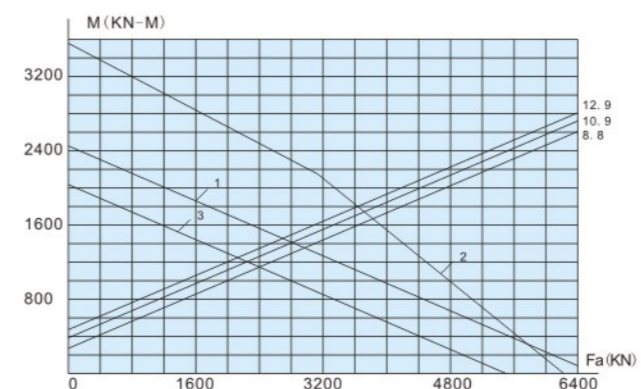

Fig. 3-95 3-944G2

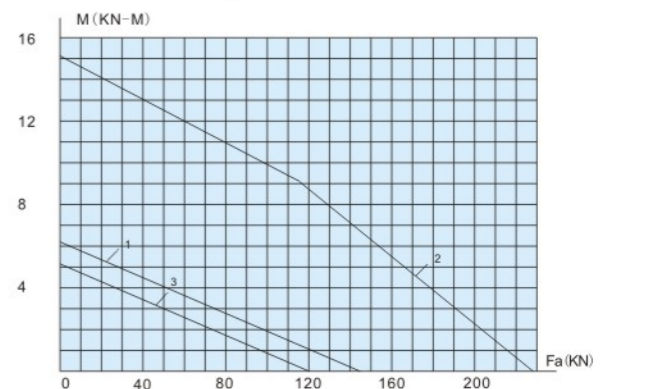

Fig. 3-96 D797/124.5G2

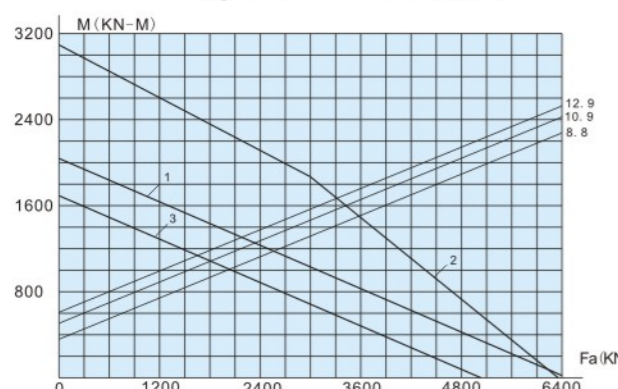

Fig. 3-89 797/1250G2

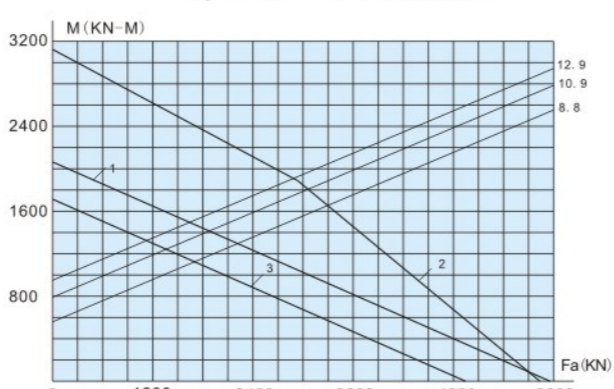

Fig. 3-90 792/1250G2

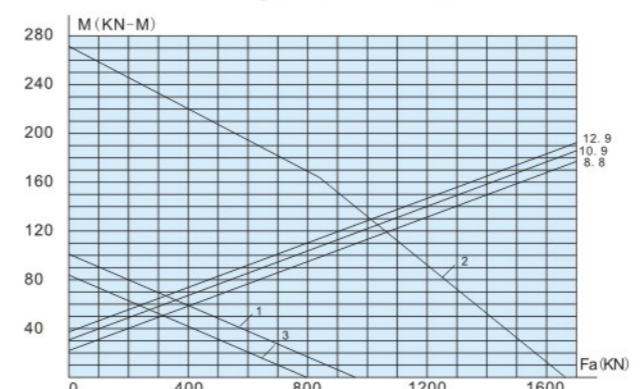

Fig. 3-97 79764

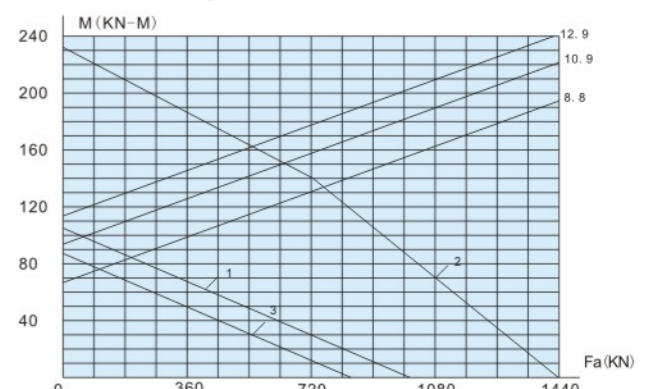

Fig. 3-98 110.20.435.12



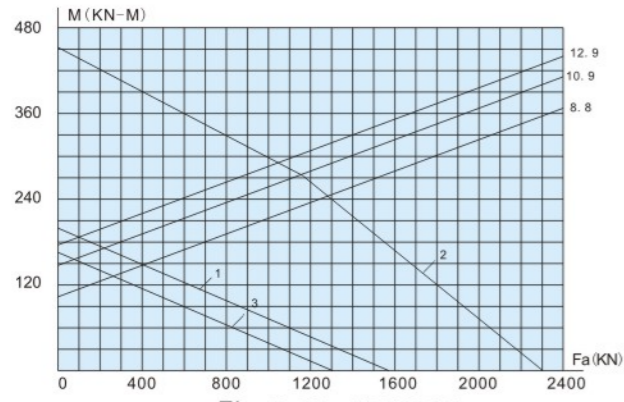

Fig. 3-99 79780G2

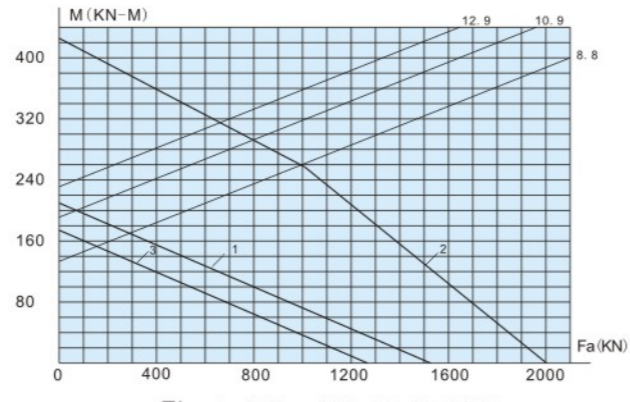

Fig. 3-100 110.25.574/P5

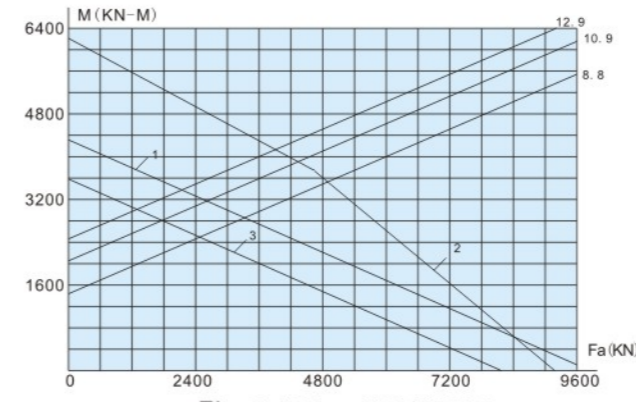

Fig. 3-107 797/1600G

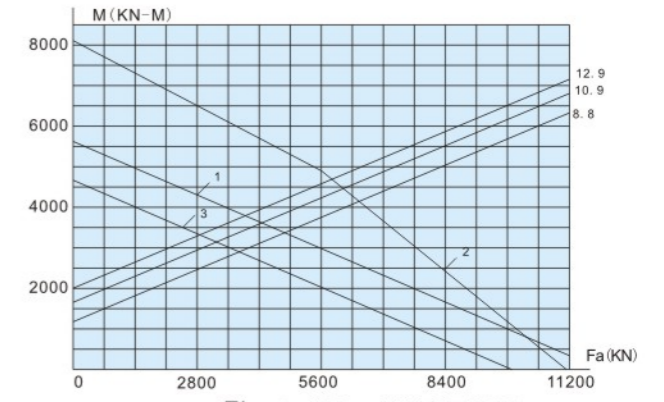

Fig. 3-108 797/1776G2

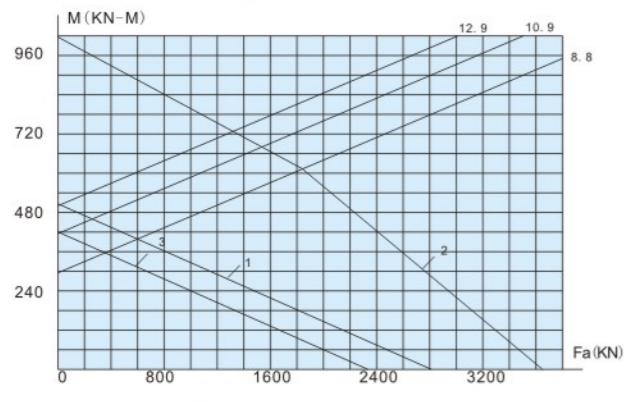

Fig. 3-101 797/600G2

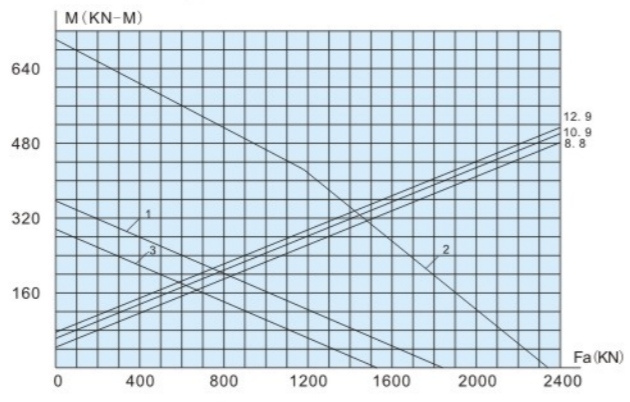

Fig. 3-102 797/670

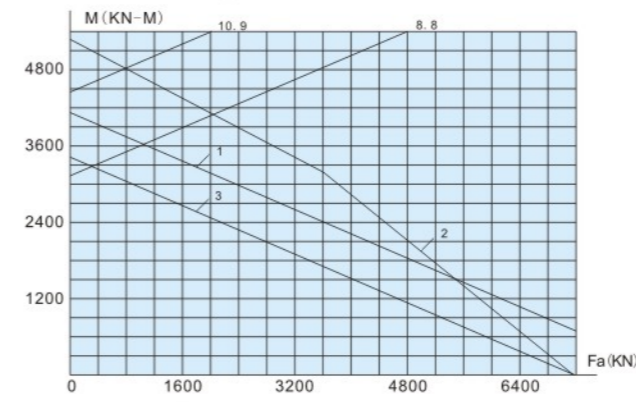

Fig. 3-109 110.40.2000.12

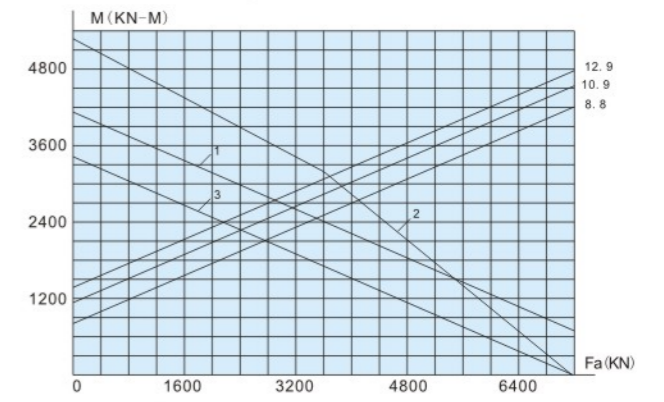

Fig. 3-110 110.40.2000.03K

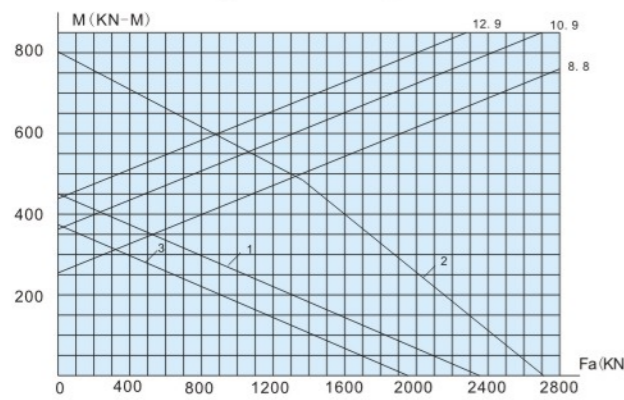

Fig. 3-103 110.280.800.04

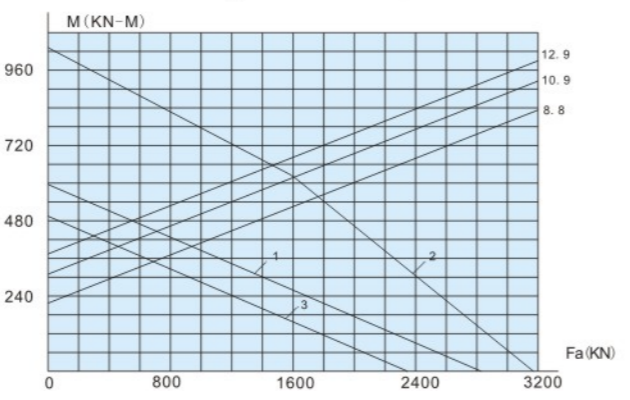

Fig. 3-104 797/700G

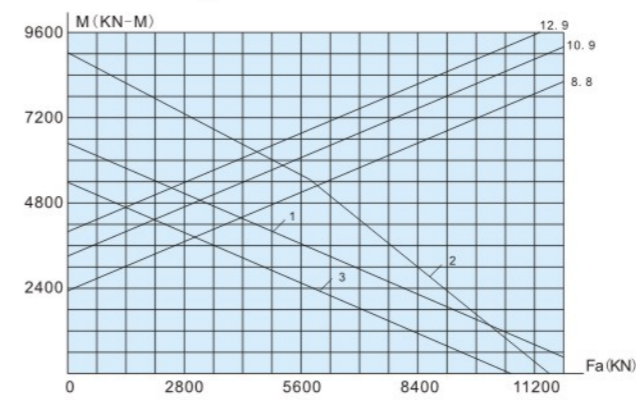

Fig. 3-111 797/1860G2

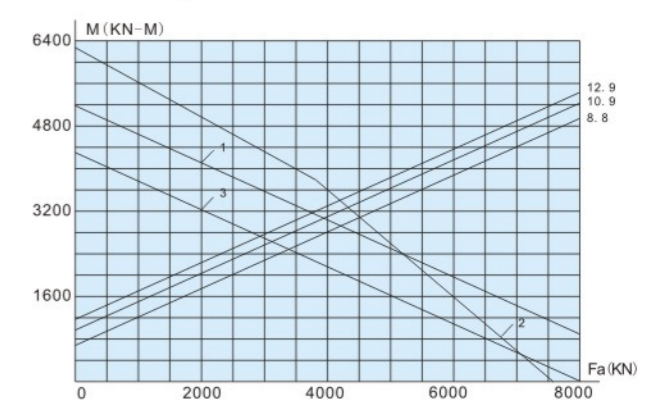

Fig. 3-112 110.40.2240.12K

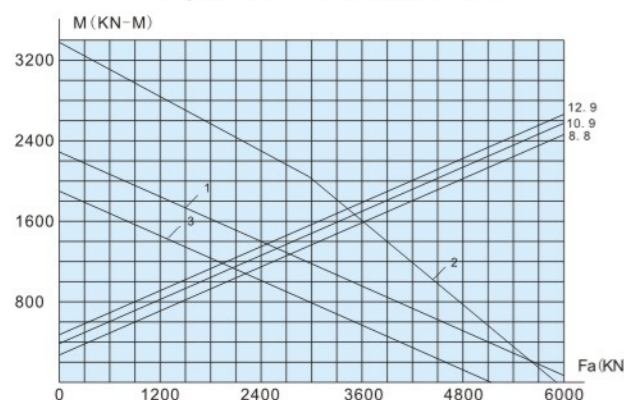

Fig. 3-105 3-944G2K

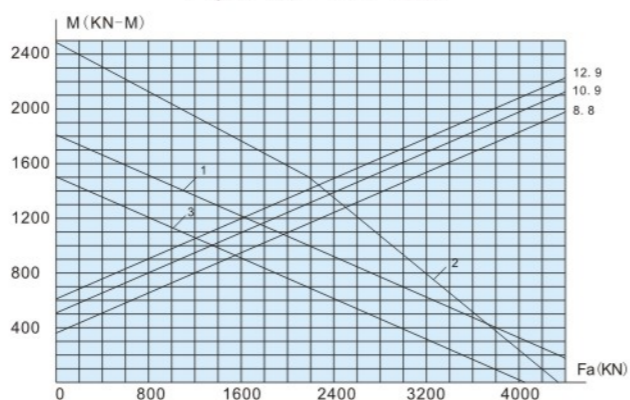

Fig. 3-106 3-944G2K2

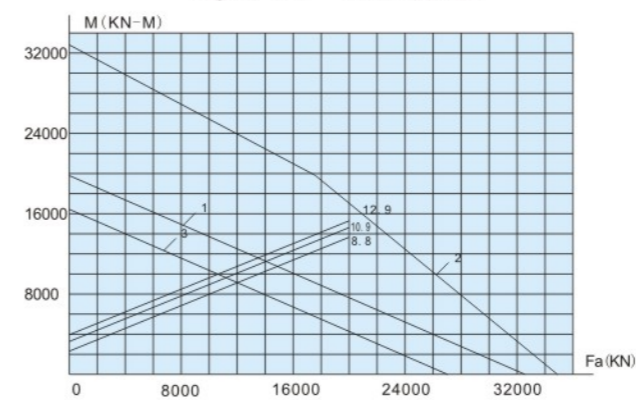

Fig. 3-113 797/2190G

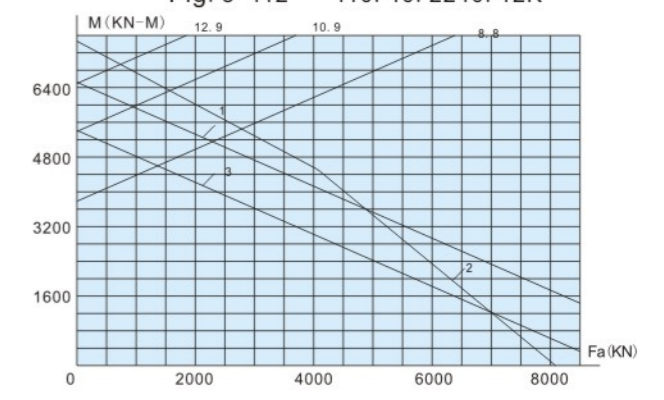

Fig. 3-114 110.40.2500.12



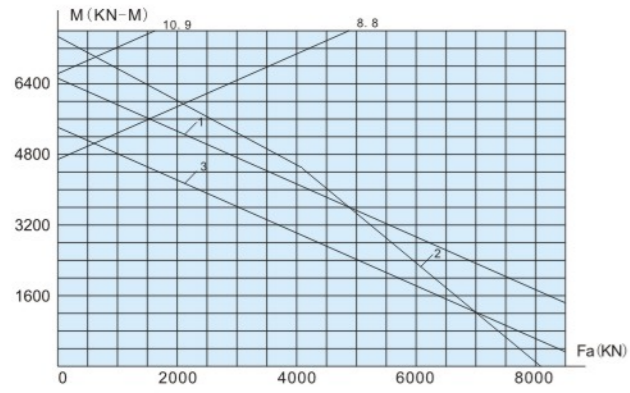

Fig. 3-115 110.40.2500.12K

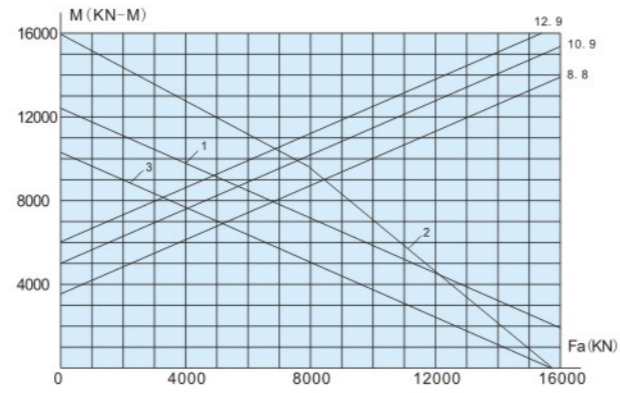

Fig. 3-116 797/2500G2

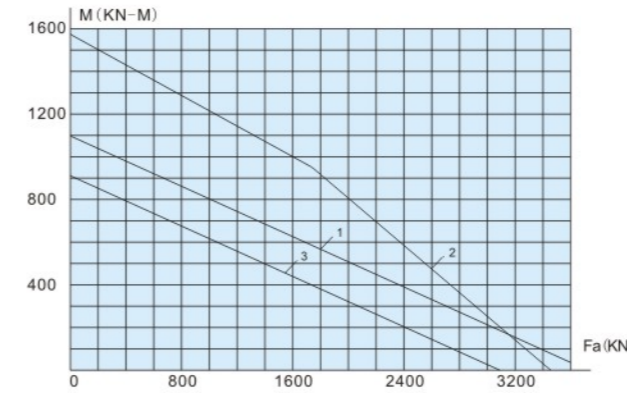

Fig. 3-123 LY-8010

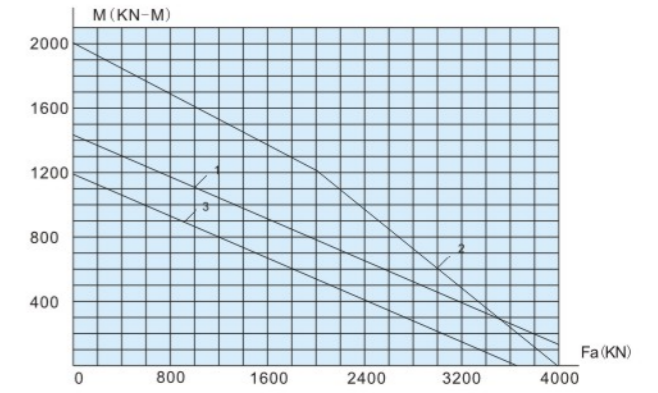

Fig. 3-124 797/1200G2

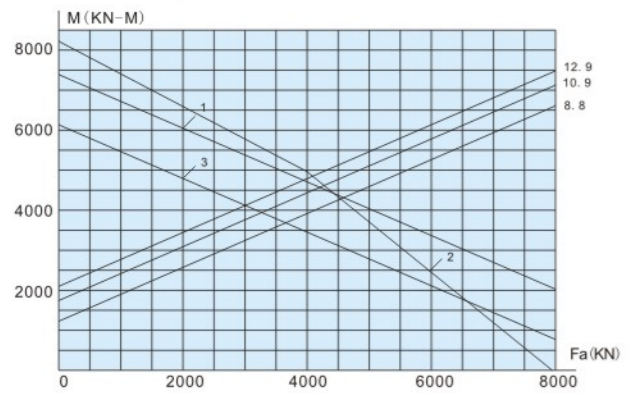

Fig. 3-117 110.40.2800.11K

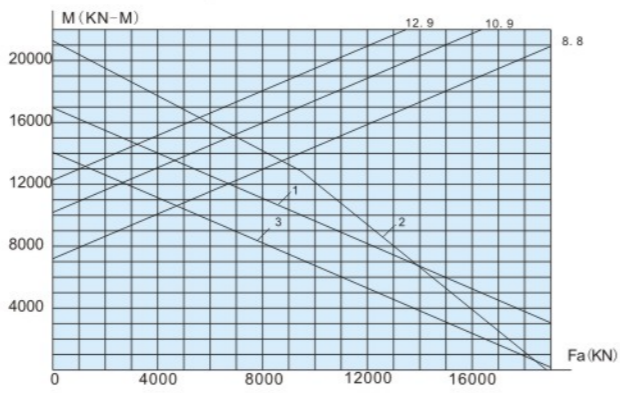

Fig. 3-118 792/2800G

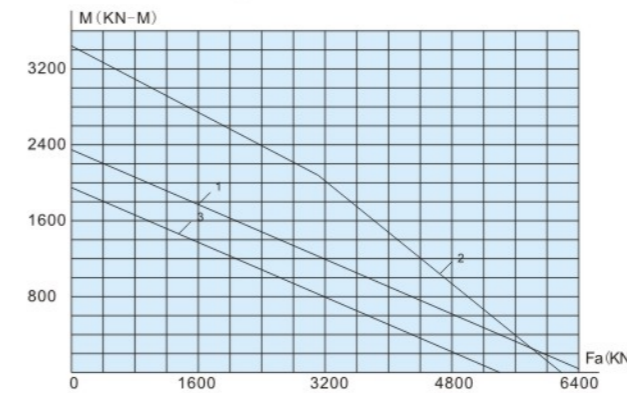

Fig. 3-125 797/1320G2

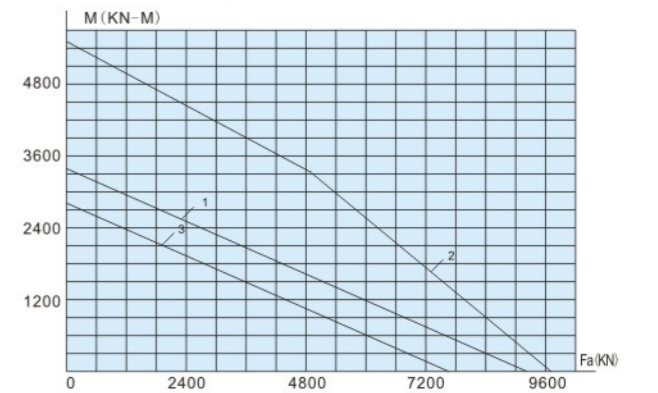

Fig. 3-126 D797/1320G2K2

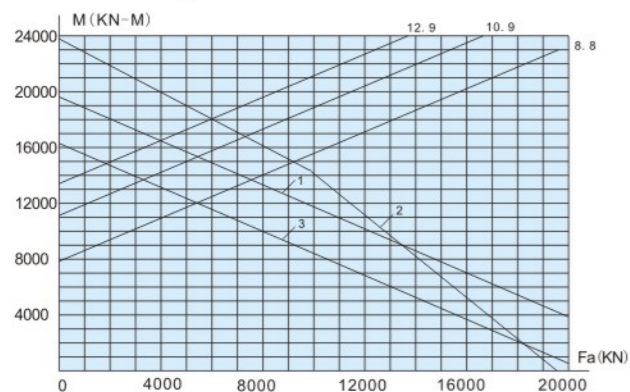

Fig. 3-119 D797/2992

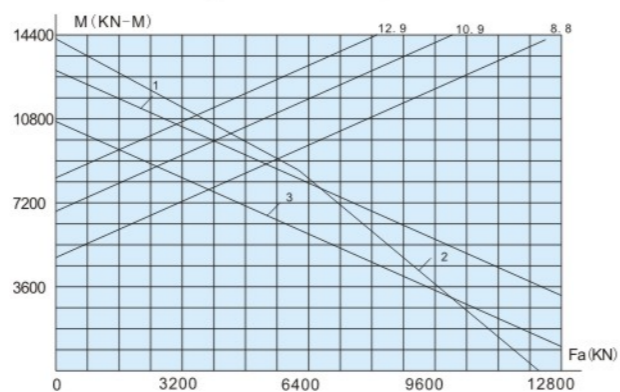

Fig. 3-120 110.50.3150.03K

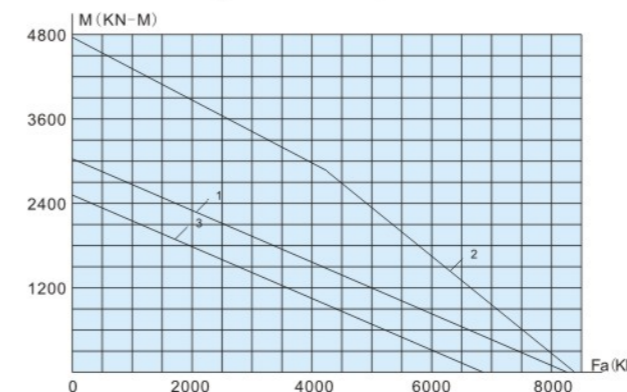

Fig. 3-127/3-128/3-129 797/1320G2K

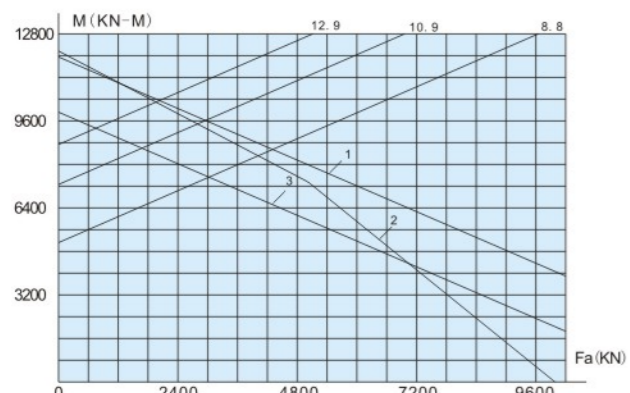

Fig. 3-121 110.40.3300.03

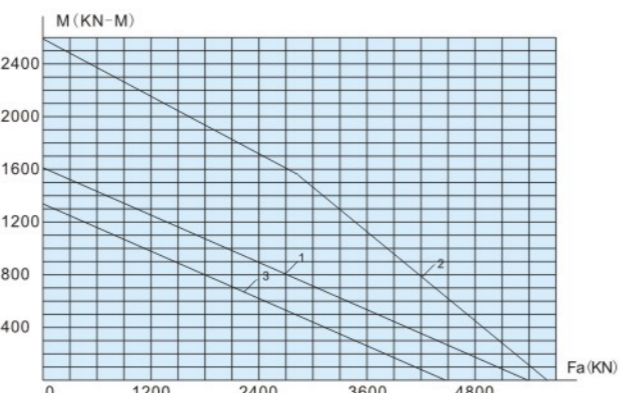
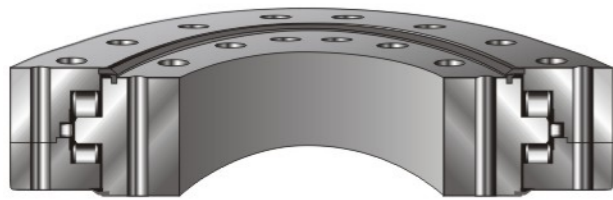

Fig. 3-122 797/1060G2



### Three-row Cylindrical Roller Combined Slewing Bearing



Type 130 (Type 539000)

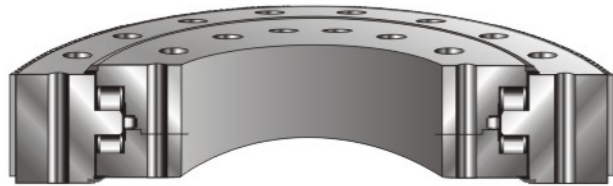

Type 131/132 (Type 639000)

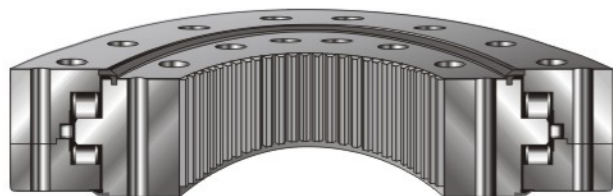

Type 133/134 (Type 739000)

▲ The design's of all these slewing rings are based on standard structures; LYC can design and manufacture many other similar structures in accordance to the special and particular requirements of their customers'. If our customer's have specific requests then the customer should identify the structure, and mounting dimensions that are required. Please contact the LYC Technical Center if you need any assistance in this area.

### Three-row Cylindrical Roller Slewing Bearing

The LYC three-row cylindrical roller slewing bearing can carry axial load, tilting moment, and radial load at the same time. Compared to cross-cylindrical roller slewing bearing, the load of each roller is reduced. Point contact is changed into line contact compared with that of a double row ball slewing bearing, and the contact stresses are also decreased. Therefore, the load capacity of this design of slewing bearing is the highest under the conditions of a bearing with the same boundary dimensions. Axial load and radial load

for this design are loaded by different rollers, in which the axial load and tilting moment are loaded by two groups of horizontal placed rollers, the radial load is loaded by one group of vertical placed rollers.

LYC three-row cylindrical roller slewing bearing mainly consists of the components such as inner ring, outer ring, three rows of rollers, cage (spacing blocks), and a seal device etc.

The design is suitable for most

applications where there is a large axial load, tilting moment, a larger radial load, or a low requirement for friction moment.

The basic structure of LYC three-row cylindrical roller slewing bearing as below:

- Without gear (Type 130)
- External gear (Type 131/ Type 132)
- Internal gear (Type 133/ Type 134)

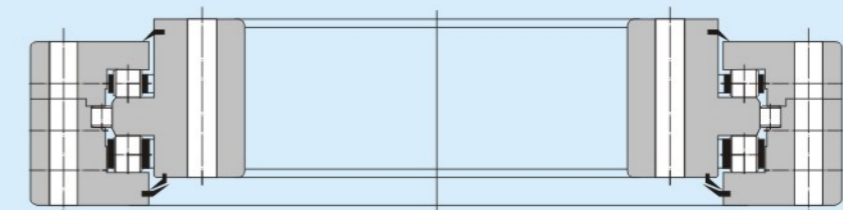

Type 130 (Type 539000)

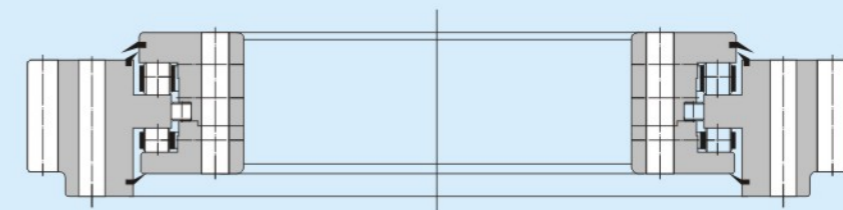

Type 131/132 (Type 639000)

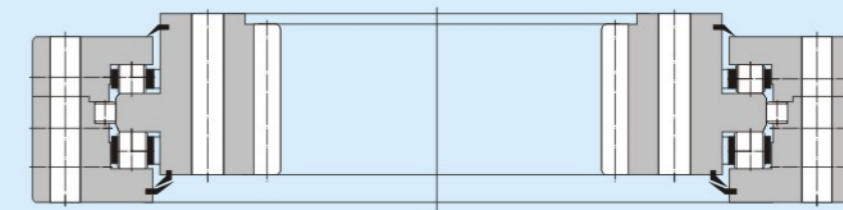

Type 133/134 (Type 739000)



### Three-row Cylindrical Roller Slewing Bearing-with Internal Teeth

d1500~2868mm

Boundary Dimension			Bearing Type	Related Dimension										
d	D	T		D1	d1	d2	Dwp	H	h	n1	n2	n3	φ1	φ2
mm			mm											
1500	1910	186	7397/1500	1844	1566	1679	1714	186	20	6	48	48	ZG1/4	33
1605	1995	220	133.40.1800.12K	1943	1657	1760	1801	210	50	6	60	60	M10×1	26
1779	2239	231	133.45.2000.03K	2161	1845	1967	2000	219	54	6	60	60	M10×1	39
1833	2427	206	7397/1833	2323	1941	2114	2136	193	13	8	40	40	ZG1/4	52
1890	2620	410	133.90.2245.03	2520	1980	2185	2245	410	90	6	56	56	20	45
1910	2320	160	133.30.2130.03	2255	1990	2107	2130	140	20	4	40	30	M10×1	37.5
1940	2385	231	133.45.2150.03	2315	2010	2111	2145	219	53	6	60	28	M10×1	M36
1995	2458	219	134.40.2234.03	2380	2085	2196	2234	210	42	6	60	60	M10×1	39
2019	2479	231	133.45.2240.03K	2401	2085	2207	2240	219	54	8	80	80	M10×1	M36
2019	2479	231	133.45.2240.03K1	2395	2085	2207	2240	219	54	8	72	72	M10×1	M36
2216	2650	220	7397/2216K	2590	2276	2392	2430	197	35	8	40	56	M10×1	33
2269	2721	231	133.45.2500.03K4	2655	2341	2466	2500	219	54	8	72	72	M10×1	39
—	2718	181	7397/2178	2640	2345	2470	2500	172	42	7	44	44	ZG1/4	39
2279	2721	231	133.45.2500.03K	2655	2345	2463	2500	219	54	15	90	90	M10×1	M36
2279	2721	241	133.45.2500.03K3	2655	2341	2466	2500	229	54	4	72	46	M10×1	39
2279	2721	231	133.45.2500.03K5	2655	2341	2466	2500	219	54	4	72	46	M10×1	39
2395	2965	270	133.50.2694.03	2880	2510	2648	2694	255	50	8	72	72	M10×1	M39
2398	2900	220	7397/2398	2798	2512	2592	2643	202	30	10	104	112	M10×1	M36
2556	3018	220	133.40.2794.03	2940	2645	2757	2794	210	42	8	72	72	M10×1	39
2558	3032	231	7397/2480	2960	2640	2767	2800	219	12	5	90	90	G1/4	36
2570	3145	288	7397/2570K1	3060	2645	2820	2855	278	54	10	100	98	M10×1	39
2579	3021	231	133.45.2800.03	2955	2645	2767	2800	219	54	8	72	72	M10×1	33
2579	3021	231	133.45.2800.11	2955	2645	2767	2800	219	54	8	72	72	ZG1/4	33
—	2988	176	7397/2506	2910	2653	2752	2790	164	36	8	56	56	ZG1/4	39
—	3160	260	7397/2520	3080	2725	2863	2910	210	50	8	84	84	ZG1/4	39
2638	3100	200	7397/2560	3000	2750	2834	2869	195	30	10	120	120	M10×1	M30
2700	3150	255	7397/2700K	3070	2750	2856	2910	225	40	6	72	72	ZG1/4	32
2700	3150	255	7397/2700G2	3070	2750	2856	2910	225	40	4	72	40	M14×1.5	32
2700	3150	255	7397/2700G2K	3070	2750	2856	2910	225	40	6	72	72	ZG1/4	32
2700	3150	255	7397/2700GK1	3070	2755	2856	2910	225	40	4	80	76	M14×1.5	38
2700	3150	255	7397/2700G2K2	3070	2750	2856	2910	225	40	6	72	72	ZG1/4	33
2700	3150	255	7397/2700G2K3	3070	2750	2856	2910	225	40	4	2	8	M14×1.5	M30
2750	3185	201	133.35.2956.03K1	3104	2835	2918	2956	180	38	10	84	84	M10×1	M36
2751	3185	201	133.35.2956.03	3104	2835	2918	2956	180	38	10	96	96	M10×1	M36
2751	3185	201	133.35.2956.03K	3104	2835	2918	2956	180	38	10	84	84	M10×1	M36
2751	3215	200	133.35.2956.03K2	3104	2835	2918	2956	185	38	10	96	96	M10×1	M36
2751	3215	200	133.35.2956.03K3	3104	2835	2918	2956	185	38	10	84	84	M10×1	M36
2751	3215	200	133.35.2956.03K4	3104	2835	2918	2956	185	38	10	84	84	M10×1	M36
—	3185	280	134.50.2958.03	3104	2835	2905	2958	260	38	15	84	84	M10×1	M36
2850	3420	268	7397/2850	3325	2950	3096	3142	258	50	10	80	80	ZG1/4	45
2860	3410	264	7397/2860	3315	2965	3107	3150	248	53	6	48	48	10	M36
2868	3432	270	133.50.3150.03	3342	2958	3103	3150	258	50	8	60	60	M10×1	39
2868	3432	270	133.50.3150.03K	3342	2958	3103	3150	258	65	11	110	110	M10×1	M36
2868	3432	270	133.50.3150.03K1	3342	2958	3103	3150	258	65	8	72	72	M10×1	45
2868	3432	270	133.50.3150.03K2	3342	2958	3103	3150	258	65	11	110	110	M10×1	39
2868	3432	270	133.50.3150.03K3	3342	2958	3103	3150	258	65	11	110	110	M10×1	45
2868	3432	270	133.50.3150.11K	3342	2958	3103	3150	258	50	8×2	60	60	M10×1	39
2868	3432	270	133.50.3150.11K1	3342	2958	3103	3150	258	50	12	72	72	ZG1/4	45
2868	3432	270	133.50.3150.12K	3342	2958	3103	3150	258	50	8	60	60	M10×1	39

φ3	Gear Parameter					Weight	Loading Curve
	da	b	m	Z	x		
						kg ≈	
33	1408	140	16	89	0.5	1315	Fig.4-1
26	1531.6	150	14	110	0.5	1665	Fig.4-2
39	1702.4	160	16	107	0.5	2213	Fig.4-3
52	1764	140	14	126	1	2538	Fig.4-4
45	1800	210	18	101	0.5	6349	Fig.4-5
37.5	1821.6	110	14	132	0	1551	Fig.4-6
38	1848	107	16	117	0.25	2322	Fig.4-7
39	1908	130	18	107	0.5	2536	Fig.4-8
39	1926.4	160	16	121	0.5	2422	Fig.4-9
39	1926.4	160	16	121	0.5	2426	Fig.4-10
M30	2129.8	140	16	135	0	2418	Fig.4-11
39	2185.2	160	18	122	0.5	2761	Fig.4-12
39	2178	139	18	122	0.5	2316	Fig.4-13
39	2185.2	160	18	122	0.5	2517	Fig.4-14
39	2185.2	170	18	122	0.5	2960	Fig.4-15
39	2185.2	160	18	122	0.5	2762	Fig.4-15
42	2288	215	22	105	0.5	4001	Fig.4-16
41	2320	180	16	146	0.5	2910	Fig.4-17
39	2460	140	20	124	0.5	2904	Fig.4-18
36	2480	142	16	156	0.5	3334	Fig.4-19
39	2484	180	18	139	0.5	4525	Fig.4-20
33	2484	160	18	139	0.5	3106	Fig.4-21
33	2484	160	18	139	0.5	3106	Fig.4-21
39	2506	140	14	180	0.5	2239	Fig.4-22
39	2520	210	24	106	0.5	3954	Fig.4-23
35	2560	170	16	161	0.5	2769	Fig.4-24
32	2604	180	20	132	0	3542	Fig.4-25
32	2608.8	180	20	132	0	3550	Fig.4-25
32	2604	180	20	132	0	3542	Fig.4-25
38	2608.8	180	20	132	0	3393	Fig.4-26
33	2604	180	20	132	0	3542	Fig.4-25
32	2608.8	180	20	132	0	3699	Fig.4-25
39	2672	162	16	168	0.5	2697	Fig.4-28
39	2664	162	18	149	0.5	2691	Fig.4-27
39	2664	162	18	149	0.5	2729	Fig.4-28
39	2664	161	18	149	0.5	2691	Fig.4-27
39	2664	161	18	149	0.5	2691	Fig.4-28
39	2672	161	16	168	0.5	2745	Fig.4-28
39	2664	242	18	149	0.5	4104	Fig.4-29
45	2736	213	24	115	0.5	5028	Fig.4-30
M36	2768.4	169	18	155	0.4	4822	Fig.4-31
39	2760.54	180	20	139	0.5	5174	Fig.4-32
39	2768	180	20	139	0.5	4820	Fig.4-33
45	2768	180	20	139	0.5	4843	Fig.4-34
39	2768	180	20	139	0.5	4820	Fig.4-33
39	2760.54	180	20	139	0.5	5174	Fig.4-32
45	2754.44	180	18	154	0.5	5019	Fig.4-34
39	2760.54	180	20	139	0.5	5174	Fig.4-32

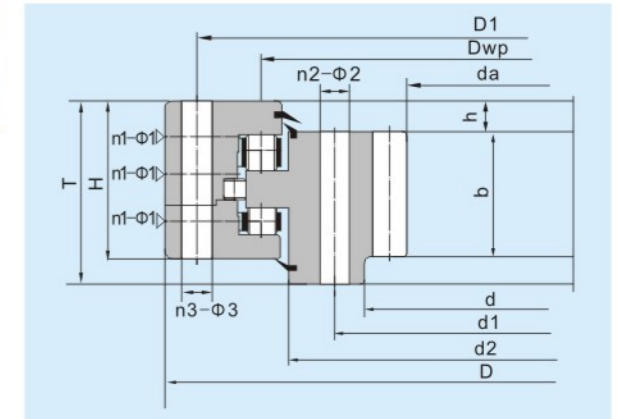



### Three-row Cylindrical Roller Slewing Bearing-with Internal Teeth

d2868--4190mm

Boundary Dimension			Bearing Type	Related Dimension										
d	D	T		D1	d1	d2	Dwp	H	h	n1	n2	n3	φ1	φ2
mm			mm											
2868	3432	270	133.50.3150.12K1	3342	2958	3103	3150	258	50	8	60	60	M10×1	39
2868	3432	270	134.50.3150.11K	3342	2958	3103	3150	258	50	6	72	72	ZG1/4	45
2896	3369	220	133.40.3145.03	3291	2979	3108	3145	210	42	10	80	80	M10×1	39
2896	3419	268	134.50.3173.03	3344	2979	3129	3175	258	65	12	108	108	M10×1	39
—	3788	233	133.45.3550.04	3710	3385	3512	3550	221	54	20	80	80	M12	39
3268	3832	270	133.45.3560.03	3742	3358	3504	3560	258	65	12	120	120	M10×1	M36
3268	3832	270	133.50.3550.03K	3742	3358	3474	3550	258	65	8	72	72	M10×1	46
—	3832	192	133.36.3610.03	3754	3448	3585	3610	180	12	16/8	96	96	M10×1	39
3296	3779	260	133.50.3550.03K1	3701	3379	3504	3550	250	46	18	108	108	M10×1	39
—	4270	298	7397/3576	4175	3800	3948	4000	288	10	12	72	72	M10×1	45
3540	3945	203	133.40.3740.03	3870	3610	3718	3743	172	42	7	84	84	M10×1	33
—	4451.35	317.5	133.60.4130.03	4350	3886	4043.5	4132	306	50.8	11	110	110	M10×1	48
3820	4500	274	7397/3900	4408	4005	4167	4210	264	44	8	80	80	M10×1	45
3735	4238	215	7397/3630	4160	3835	3975	4014	210	50	8	96	96	M10×1	39
4190	5000	430	3-945G2	4880	4310	4482	4570	400	175	12	72	66	M10×1	44

φ3	Gear Parameter					Weight kg ≈	Loading Curve
	da	b	m	Z	x		
39	2754.44	180	18	154	0.5	5174	Fig.4-32
45	2750.66	180	22	126	0.5	5014	Fig.4-34
39	2800	154	20	141	0.5	3595	Fig.4-35
39	2800	170	20	141	0.5	4435	Fig.4-36
39	3190.6	179	22	146	+0.5	4272	Fig.4-37
39	3168	180	20	159	0.5	5474	Fig.4-38
46	3168.386	180	18	177	0.5	5450	Fig.4-39
39	3302.4	148	16	208	0	3461	Fig.4-40
39	3200	190	20	159	0.5	4485	Fig.4-41
45	3576	233	24	150	0.5	7852	Fig.4-42
33	3440	156	20	173	0.5	2802	Fig.4-43
48	3642.74	266.7	25.4	143	1	10136	Fig.4-44
45	3804	230	20	191	0.5	6895	Fig.4-45
39	3630	164	22	166	0.5	4535	Fig.4-46
44	4068	240	25	164	0.35	14204	Fig.4-47

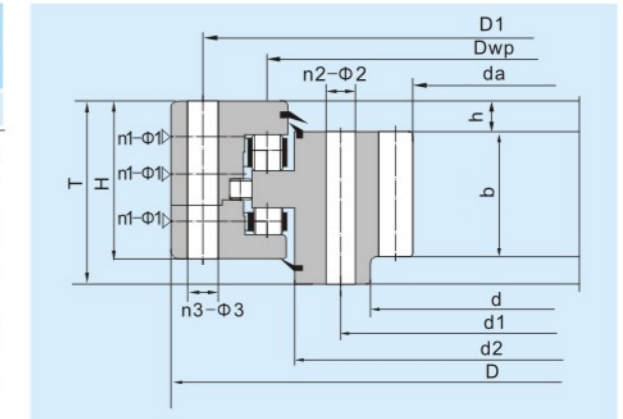



### Three-row Cylindrical Roller Slewing Bearing-with External Teeth

d576~2868mm

Boundary Dimension			Bearing Type	Related Dimension										
d	D	T		D1	d1	d2	H	h	Dwp	n1	n2	n3	φ1	φ2
mm			mm											
576	844	148	131.25.710.12	808	612	747	710	138	32	4	28	28	G1/4	18
576	844	148	132.25.710.12	808	612	747	710	138	32	4×3	28	28	M10×1	18
1453	—	132	6397/1453	1705	1505	1630	1600	123	9	5	40	40	M10×1	26
1545	1860	165	6397/1545G2	1810	1590	1752	1710	157	27	4	36	36	21	22
1600	1920	160	6397/1600G2	1870	1650	1802	1760	152	27	4	34	36	25	26
1601	1985	168	131.25.1784.03	1922	1671	1824	1784	153	28	6	48	48	M10×1	33
1605	1984	250	6397/1605G2K	1932	1657	1850	1801	217	50	6	48	36	M14×1.5	26
1620	1916	138	131.22.1770.03	1860	1670	1809	1770	129	34	5	44	44	M10×1	27
1779	2221	231	131.45.2000.04	2155	1845	2055	2000	219	54	6	60	60	M10×1	33
1800	2207	181	131.32.2000.03	2141	1866	2041	2000	172	42	6	46	60	M10×1	34
1816	2195	150	132.25.2000.03	2127	1885	2050	2001	137	33	3	60	60	ZG1/4	33
1816	2195	150	132.32.2000.03	2127	1885	2050	2003	137	33	3	60	60	ZG1/4	33
1850	2465	256	3-947G	2390	2020	2261	2202	236	46	6	60	60	M10×1	39
1990	2500	241	6397/1990	2410	2070	2295	2240	219	22	12	48	48	M10×1	45
2001	2350	184	6397/2001	2291	2054	2226	2172	172	12	4	100	100	G1/4	26
2019	2461	231	132.45.2240.03	2395	2085	2295	2240	219	54	6	60	60	M10×1	33
2221	2792	231	131.45.2500.03K1	2695	2325	2562	2500	219	54	4	68	68	M10×1	52
2236	2905	315	132.50.2555.03	2802	2348	2643	2555	305	50	24	64	64	M10×1	56
2240	2650	180	3-934G	2588	2300	2487	2445	165	15	6	54	54	M14×1.5	34
2279	2721	231	131.45.2500.03	2655	2345	2555	2500	219	54	8	72	72	M10×1	33
2279	2721	231	131.45.2500.04	2655	2345	2555	2500	219	54	8	72	72	M10×1	33
2279	2721	231	131.45.2500.12	2655	2345	2555	2500	219	54	8	72	72	M10×1	33
2319	—	147	6397/2319	2625	2385	2536	2500	138	30	6	54	54	ZG1/4	33
2369	2748	179	6397/2369	2684	2435	2597	2556	163	30	6	78	78	ZG1/4	33
2562	—	220	131.40.2800.03	2965	2640	2850	2800	210	50	8	48	48	ZG1/4	39
2562	—	220	131.40.2800.11	2965	2640	2850	2800	210	50	8	48	48	ZG1/4	39
2579	3021	231	131.45.2800.03	2955	2645	2855	2800	219	54	8	72	72	M10×1	33
2579	3021	231	131.45.2800.03K	2955	2645	2855	2800	219	54	8	72	72	M10×1	33
2579	3021	231	131.45.2800.11	2955	2645	2855	2800	219	54	8	72	72	M10×1	33
2579	3021	231	131.45.2800.12	2955	2645	2855	2800	219	54	8	72	72	M10×1	33
2579	3021	231	131.45.2800.12K	2955	2645	2855	2800	219	54	8	72	72	M10×1	35
2579	3021	231	132.45.2800.03	2955	2645	2855	2800	219	54	8	72	72	M10×1	33
2579	3021	231	132.45.2800.12	2955	2645	2855	2800	219	12	8	72	72	M10×1	33
2585	3015	190	6397/2585	2949	2651	2838	2794	178	47	8	56	56	M10×1	33
2590	3006	200	6397/2590	2930	2670	2860	2814	180	21	10	60	60	M10×1	39
2590	3006	314	6397/2590K	2930	2670	2860	2814	290	24	10	60	60	M10×1	39
2599	3376	350	6397/2599K1	3186	2711	3039.5	2948.5	341	70	8	72	72	M10×1	56
2669	3360	403	6397/2669K	3256	2781	3100	3005	394	64	8	72	72	M10×1	56
2800	3260	220	6397/2800	3190	2870	3082	3030	202	30	6	60	60	M14×1.5	39
2800	3260	220	6397/2800K	3190	2870	3100	3054	202	30	6	60	60	M10×1	39
2800	3260	220	6397/2800G	3190	2870	3082	3030	202	30	6	60	60	M14×1.5	39
2800	3255	240	6397/2800GK	3185	2870	3082	3030	202	30	8	64	48	M14×1.5	39
2800	3255	240	6397/2800GK1	3185	2870	3082	3030	202	30	8	64	64	M14×1.5	M36
2800	3360	220	6397/2800G2	3190	2870	3082	3030	202	30	6	60	60	M14×1.5	39
2800	3260	220	6397/2800G2K1	3190	2870	3082	3030	202	30	6	60	60	M10×1	39
2800	3255	240	6397/2800GK2	3185	2870	3082	3030	202	30	8	64	48	M14×1.5	M36
2868	3432	270	131.50.3150.03	3342	2958	3213	3150	258	65	8	72	72	M10×1	45
2868	3432	270	131.50.3150.03K	3342	2958	3213	3150	258	65	8	72	72	NPT1/4	45

φ3	Gear Parameter					Weight kg ≈	Loading Curve
	da	b	m	Z	x		
18	886.8	80	6	145	0.5	290	Fig.4-94
18	888	80	8	108	0.5	291	Fig.4-94
26	1831.2	106	14	128	0.5	724	Fig.4-95
22	1932	100	14	136	0	965	Fig.4-96
26	2001	90	14	140	0.5	999	Fig.4-97
33	2060.16	126	16	126	0.38	1220	Fig.4-98
26	2064	170	16	127	0	1800	Fig.4-99
27	1988	80	14	140	0	764	Fig.4-100
33	—	—	—	—	—	2230	Fig.4-101
34	2284.8	120	16	140	0.5	1549	Fig.4-102
33	2267	105	16	138	0.9	1120	Fig.4-103
33	2267	105	16	138	0.9	1110	Fig.4-104
39	2554	180	18	139	0.5	3515	Fig.4-105
45	2596.157	160	16	159	0.675	2780	Fig.4-106
26	2427.2	120	16	148	1	1490	Fig.4-107
33	2556	160	18	139	0.5	2430	Fig.4-108
52	2876.4	160	18	157	0.5	3172	Fig.4-111
56	2996	180	20	147	0.5	5456	Fig.4-109
34	2754	132	18	150	0.5	1932	Fig.4-110
33	2826	160	18	154	0.5	2831	Fig.4-112
33	2826	160	18	154	0.5	2834	Fig.4-112
33	2826	160	18	154	0.5	2834	Fig.4-112
33	2786.4	117	18	152	0.5	1539	Fig.4-113
33	2805.6	100	12	231	0.5	1734	Fig.4-114
39	3136	170	20	154	0.5	3073	Fig.4-115
39	3136	170	20	154	0.5	3073	Fig.4-115
33	3110.4	160	18	170	0.5	3040	Fig.4-116
33	3110.4	160	18	170	0.5	3040	Fig.4-116
33	3114	160	18	170	0.5	3010	Fig.4-116
33	3114	160	18	170	0.5	3010	Fig.4-116
35	3114	160	18	170	0.5	3010	Fig.4-116
33	3120	160	20	153	0.5	3031	Fig.4-116
33	3120	160	20	170	0.5	3010	Fig.4-116
33	3114	120	18	170	0.5	2345	Fig.4-117
39	3086	95	16	190	0.4375	2780	Fig.4-118
39	3085.21	134	16	190	0.4375	4209	Fig.4-119
56	3376	180	20	166	0.5	6816	Fig.4-120
56	3456	200	20	170	0.5	8515	Fig.4-121
39	3360	160	20	166	0	3288	Fig.4-123
39	3360	160	20	166	0	3360	Fig.4-122
39	3360	160	20	166	0	3288	Fig.4-123
39	3348	160	18	184	0	3419	Fig.4-124
39	3348	180	18	184	0	3429	Fig.4-125
39	3360	160	20	166	0	3288	Fig.4-123
39	3360	160	20	166	0	3288	Fig.4-126
39	3348	160	18	184	0	3424	Fig.4-125
45	3536	180	20	174	0.5	4897	Fig.4-127
45	3536	180	20	174	0.5	4897	Fig.4-127

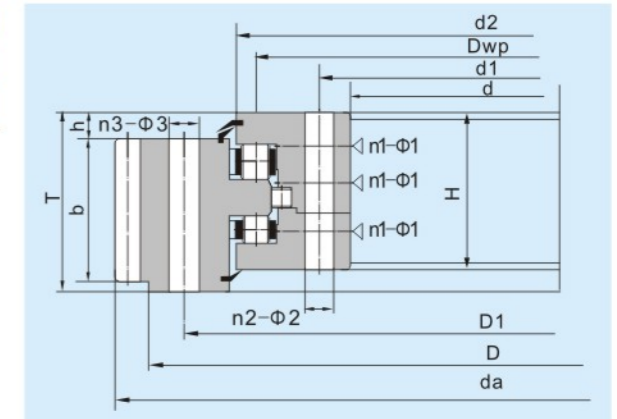



### Three-row Cylindrical Roller Slewing Bearing-with External Teeth

d2868~3718mm

Boundary Dimension			Bearing Type	Related Dimension										
d	D	T		D1	d1	d2	H	h	Dwp	n1	n2	n3	φ1	φ2
mm			mm											
2868	3432	270	131.50.3150.04	3342	2958	3213	3150	258	65	8	72	72	M10×1	45
2868	3432	270	131.50.3150.11	3342	2958	3213	3150	258	65	8	72	72	ZG1/4	45
2868	3432	270	131.50.3150.11K	3342	2958	3213	3150	258	65	8	72	72	ZG1/4	45
2868	3432	270	131.50.3150.11K1	3342	2958	3213	3150	258	65	8	72	72	ZG1/4	45
2868	3432	270	131.50.3150.12	3342	2958	3213	3150	258	65	8	72	72	M10×1	45
2868	3432	270	131.50.3150.12K	3342	2958	3214	3150	258	50	8×2	72	72	ZG1/4	45
2868	3432	270	131.50.3150.12K1	3342	2958	3214	3150	258	50	8	72	72	M10×1	45
2868	3435	270	131.50.3150.12K3	3342	2958	3214	3150	258	50	12	60	60	M10×1	40
2868	3432	270	131.50.3150.12K4	3342	2958	3213	3150	258	65	8	72	72	ZG1/4	45
2868	3432	270	132.50.3150.03	3342	2958	3213	3150	258	65	8	72	72	M10×1	45
2868	3432	270	132.50.3150.03K	3342	2958	3213	3150	258	65	8	72	72	M10×1	45
2868	—	270	132.50.3150.03K1	3342	2958	3213	3150	258	65	8	72	72	M10×1	45
2868	3432	270	132.50.3150.03K2	3342	2958	3213	3150	258	65	8	72	72	M10×1	45
2868	3432	270	132.50.3150.04	3342	2958	3213	3150	258	65	8	72	72	M10×1	45
2868	3432	270	132.50.3150.04K	3342	2958	3213	3150	258	65	8	72	72	ZG1/4	45
2868	3432	270	132.50.3150.12K	3342	2958	3214	3150	258	50	8×2	72	72	ZG1/4	45
2868	3432	270	132.50.3150.12K1	3342	2958	3213	3150	258	65	8	72	72	ZG1/4	45
2885	3400	229	6397/2885	3310	2975	3200	3140	210	54	6	72	72	M10×1	45
2885	3400	229	131.40.3145.03	3310	2975	3200	3140	210	53	8	72	72	M10×1	39
2910	3400	220	6392/2910G	3315	2990	3200	3150	210	50	8	56	56	M14×1.5	39
2922	3376	182	131.30.3150.03	3286	3014	3190	3150	172	40	8	56	56	M10×1	45
2922	3376	182	131.30.3150.12K	3286	3014	3190	3150	172	40	8	56	56	M10×1	45
2930	3390	216	131.38.3161.03	3312	3016	3207	3161	204	42	8	72	72	M10×1	39
3268	3832	270	131.50.3550.03	3742	3358	3613	3550	258	65	8	72	72	M10×1	45
3268	3832	270	131.50.3550.04	3742	3358	3613	3550	258	65	8	72	72	M10×1	45
3268	3832	270	132.50.3550.03	3742	3358	3613	3550	258	65	8	72	72	M10×1	45
3268	3830	270	132.50.3550.03K7	3742	3358	3613	3550	258	50	8	72	72	M10×1	45
3268	3832	270	132.50.3550.12	3742	3358	3613	3550	258	65	8	72	72	M10×1	45
3268	3832	270	132.50.3550.04	3742	3358	3613	3550	258	65	8	72	72	M10×1	45
3268	3832	240	132.40.3550.03	3742	3358	3600	3550	258	50	8	72	72	M10×1	45
3268	3832	270	132.50.3550.03K1	3742	3358	3613	3550	258	65	8	72	72	ZG1/4	45
3268	3832	270	132.50.3550.03K2	3742	3358	3613	3550	258	65	8	72	72	ZG1/4	45
3268	3832	270	132.50.3550.03K3	3742	3358	3613	3550	258	65	8	72	72	M10×1	45
3268	3832	270	132.50.3550.03K4	3742	3358	3613	3550	258	65	10	72	72	ZG1/4	45
3268	3832	270	132.50.3550.03K5	3742	3358	3613	3550	258	65	10	72	72	ZG1/4	45
3268	3832	270	132.50.3550.03K6	3742	3358	3613	3550	258	65	8	72	72	M10×1	45
3268	3832	270	132.50.3550.03K8	3742	3358	3613	3550	258	65	8	72	72	ZG1/4	45
3268	3832	270	132.50.3550.11K	3742	3358	3613	3550	258	65	8	72	72	ZG1/4	45
3292	—	229	6397/3292	3732	3382	3610	3550	219	49	8	72	72	M10×1	45
3340	—	212	6397/3340	3735	3441	3642	3582	180	32	10	108	108	Z1/4	33
3340	3815	270	131.50.3596.03	3735	3441	3658	3596	258	42	9	108	108	M10×1	33
3340	3815	270	131.50.3596.03K	3735	3441	3658	3596	258	42	10	120	120	M10×1	33
3340	—	212	132.40.3582.03	3735	3441	3642	3582	180	32	10	120	120	G1/4	33
3340	—	212	132.40.3582.03K	3735	3441	3642	3582	180	32	10	108	108	G1/4	33
3340	—	212	132.40.3582.03K1	3735	3441	3642	3582	180	32	10	108	108	G1/4	33
3340	—	211	132.40.3582.03K2	3735	3435	3642	3582	180	31	10	108	108	G1/4	39
3340	—	212	132.40.3582.03K3	3735	3441	3642	3582	180	32	10	108	108	G1/4	33
3340	—	212	132.40.3582.04	3735	3441	3642	3582	180	32	10	120	120	ZG1/4	33
3415	3982	270	6397/3415G2	3892	3508	3766	3693	258	65	10	80	80	ZG1/4	45
3508	3918	250	132.40.3730.03	3845	3560	3782	3730	200	55	8	80	80	ZG1/4	26
3615	—	222	6397/3615	4041	3694	3920	3855	210	12	14	100	100	M10×1	39
3616	—	222	6397/3616	4041	3694	3922	3855	210	12	5	100	100	ZG1/4	39
3630	—	230	6397/3630	4030	3715	3937	3871	218	12	4	108	132	G1/4	36
3650	4173	222	6397/3650	4085	3740	3974	3908	210	12	6	90	90	M10×1	45
3650	—	222	6397/3650K	4085	3740	3974	3908	210	12	8	90	90	G1/4	45
3650	4173	222	6397/3650K1	4085	3740	3974	3908	210	12	6	90	90	G1/4	45
3650	4173	222	6397/3650K2	4085	3744	3974	3908	210	12	6	90	90	M10×1	45
3718	4282	270	131.50.4000.03	4192	3808	4063	4000	258	65	8	80	80	M10×1	45
3718	4282	270	131.50.4000.03K	4192	3808	4063	4000	258	65	10	80	80	ZG1/4	45
3718	4282	270	131.50.4000.04K	4192	3808	4063	4000	258	65	8	80	80	M10×1	45
3718	4282	270	132.50.4000.03	4192	3808	4063	4000	258	65	8	80	80	M10×1	45
3718	4282	270	132.50.4000.03K	4192	3808	4063	4000	258	65	8	80	80	ZG1/4	45

φ3	Gear Parameter					Weight	Loading Curve
	da	b	m	Z	x		
						kg ≈	
45	3536	180	20	174	0.5	4897	Fig.4-127
45	3540	180	20	174	0.5	4920	Fig.4-127
45	3540	180	20	174	0.5	4930	Fig.4-127
45	3540	180	20	175	0	4920	Fig.4-127
45	3540	180	20	174	0.5	4917	Fig.4-127
45	3540	180	20	174	0.5	5404	Fig.4-127
45	3536	195	20	174	0.5	5385	Fig.4-127
45	3536	180	20	174	0.5	5043	Fig.4-128
45	3546	180	18	194	0.5	4917	Fig.4-127
45	3537.6	180	25	158	0.5	4907	Fig.4-127
45	3595	180	25	141	0.5	5145	Fig.4-127
45	3595	205	25	141	0.5	5250	Fig.4-127
45	3595	180	25	141	0.5	5145	Fig.4-127
45	3537.6	180	22	141	0.5	4907	Fig.4-127
45	3537.6	180	22	158	0.5	4907	Fig.4-127
45	3542	180	22	158	0.5	5409	Fig.4-127
45	3542	180	22	158	0.5	4930	Fig.4-127
45	3475	140	16	214	0.75	3597	Fig.4-129
39	3475	140	16	214	0.75	3703	Fig.4-130
39	3520	160	22	158	0	3736	Fig.4-131
45	3476	120	20	171	0.5	2308	Fig.4-132
45	3476	120	20	171	0.5	2308	Fig.4-132
39	3493.6	145	22	156	0.5	3360	Fig.4-133
45	3936	180	20	194	0.5	5280	Fig.4-134
45	3936	180	20	194	0.5	5280	Fig.4-134
45	3933.6	180	22	176	0.5	4955	Fig.4-134
45	3948	219	25	155	0.5	5096	Fig.4-135
45	3938	180	22	176	0.5	5318	Fig.4-134
45	3938	180	22	176	0.5	5318	Fig.4-134
45	3933.6	180	22	176	0.5	4860	Fig.4-136
45	3933.6	180	22	176	0.5	4955	Fig.4-134
45	3933.6	180	22	176	0.5	4951	Fig.4-134
45	3933.6	180	22	176	0.5	4955	Fig.4-134
45	3933.6	180	22	176	0.5	5044	Fig.4-135
45	3933.6	180	22	176	0.5	5042	Fig.4-135
45	3933.6	180	22	176	0.5	5029	Fig.4-135
45	3933.6	180	22	176	0.5	4960	Fig.4-134
45	3938	180	22	176	0.5	5318	Fig.4-134
45	3936	180	20	194	0.5	4856	Fig.4-137
33	3931.2	170	24	161	0.5	3684	Fig.4-138
33	3931.2	170	24	161	0.5	4953	Fig.4-139
33	3936	170	24	161	0.5	4953	Fig.4-140
33	3931.2	170	24	161	0.5	3791	Fig.4-142
33	3931.2	170	24	161	0.5	3804	Fig.4-141
33	3931.2	170	24	161	0.5	3804	Fig.4



### Three-row Cylindrical Roller Slewing Bearing-with External Teeth

d3718~5230mm

Boundary Dimension			Bearing Type	Related Dimension										
d	D	T		D1	d1	d2	H	h	Dwp	n1	n2	n3	φ1	φ2
mm			mm											
3718	4282	270	132.50.4000.03K1	4192	3808	4063	4000	258	65	8	80	80	ZG1/4	45
3718	—	270	132.50.4000.03K2	4192	3808	4063	4000	258	65	8	80	80	ZG1/4	45
3718	4282	270	132.50.4000.03K3	4192	3808	4063	4000	258	65	12	80	80	ZG1/4	45
3718	4282	270	132.50.4000.04	4192	3808	4063	4000	258	65	8	80	80	M10×1	45
3718	4282	270	132.50.4000.12	4192	3808	4063	4000	258	65	8	80	80	M10×1	45
3762	4046	258	131.50.4000.03K1	4192	3840	4058	4000	245	53	10	72	72	ZG1/4	39
3762	—	220	132.40.4000.03	4165	3840	4050	4000	210	40	9	72	72	M10×1	39
3780	—	192	6397/3780	4165	3858	4065	4008	180	12	10	90	90	M10×1	39
3870	4423	240	6397/3870	4340	3960	4224	4152	230	10	8	80	80	M10×1	45
3925	4418	222	6397/3925	4340	4010	4234	4168	210	12	9	90	90	M10×1	45
4016	4613	307	6397/4016	4512	4112	4386	4300	290	25	15	90	90	G1/4	48
4100	4535	268	6397/4100	4375	4160	4357	4297	240	25	12	48	48	M10×1	26
4140	—	315	132.50.4438.03	4646	4230	4498	4438	355	65	12	72	72	ZG1/4	45
4218	4782	270	131.50.4500.03	4692	4308	4563	4500	258	65	8	80	80	M10×1	45
4218	4782	270	131.50.4500.04	4692	4308	4565	4500	258	60	8	80	80	M10×1	45
4218	4782	270	132.50.4500.03	4692	4308	4565	4500	258	60	10	80	80	ZG1/4	45
4218	4782	270	132.50.4500.03K1	4692	4308	4565	4500	258	60	8	80	80	ZG1/4	45
4218	4782	270	132.50.4500.03K2	4692	4308	4565	4500	258	60	8	80	80	M10×1	45
4218	4782	270	132.50.4500.03K3	4692	4308	4565	4500	258	60	8	80	80	ZG1/4	45
4218	4782	270	132.50.4500.03K4	4698	4308	4560	4500	258	65	8	80	80	ZG1/4	39
4218	4782	270	132.50.4500.03K5	4692	4308	4565	4500	258	60	8	80	80	ZG1/4	45
4218	4782	270	132.50.4500.04	4692	4308	4565	4500	258	60	10	80	80	M14×1.5	45
4218	4782	270	132.50.4500.04K	4692	4308	4565	4500	258	60	8	80	80	ZG1/4	45
4246	—	233	6397/4246	4678	4330	4568	4495	221	12	6	96	96	ZG1/4	42
4246	—	233	6397/4246K	4678	4330	4568	4495	221	19	8	96	96	ZG1/4	42
4262	—	220	131.40.4500.03	4665	4340	4550	4500	210	50	14	84	84	M10×1	39
4375	4900	275	6397/4375	4820	4455	4708	2314	250	17	11	88	88	ZG1/4	45
4440	—	235	6397/4440	4980	4540	4850	4755	235	12	10	96	96	G1/4	45
4670	5320	320	131.60.5000.04	5220	4766	5082	5000	302	65	10	100	100	M10×1	45
4670	5330	330	132.60.5000.03K	5220	4766	5082	5000	314	70	10	100	100	ZG1/4	52
4735	—	278	132.50.5000.03K	5200	4825	5060	5000	258	65	13	78	78	M10×1	45
4735	—	268	132.50.5000.03K1	5200	4825	5060	5000	258	65	8	90	90	ZG1/4	45
4747	5309	268	6397/4747	5217	4825	5118	5000	258	65	15	90	90	M10×1	39
4830	5480	336	6397/4830	5360	4930	5215	5134	321	70	12	120	120	M10×1	48
4914	5381	261	6397/4914	5295	4980	5231	5132	210	40	12	72	72	M10×1	33
5230	5940	385	131.70.5560.04	5820	5320	5685	5560	379	95	16	80	80	ZG1/4	45

φ3	Gear Parameter					Weight kg ≈	Loading Curve
	da	b	m	Z	x		
45	4395	180	25	173	0.5	6374	Fig.4-151
45	4400	205	25	173	0.5	6394	Fig.4-151
45	4395	180	25	173	0.5	6440	Fig.4-149
45	4400	180	25	173	0.5	6377	Fig.4-151
45	4400	180	25	173	0.5	6377	Fig.4-151
39	4363.2	190	24	179	0.5	5740	Fig.4-150
39	4400	180	25	173	0.5	5154	Fig.4-152
39	4336	148	20	214	0.5	3787	Fig.4-153
45	4527.6	180	22	203	0.5	5850	Fig.4-154
45	4501.827	162	20	222	0.577	4560	Fig.4-155
48	4723.2	231	24	194	0.5	8181	Fig.4-156
M24	4540	200	20	225	0	4642	Fig.4-157
45	4870	250	25	192	0.5	9412	Fig.4-158
45	4901.6	180	22	220	0.5	7346	Fig.4-159
45	4880	185	20	242	0	7250	Fig.4-159
45	4895	185	25	193	0.5	7333	Fig.4-160
45	4895	185	25	193	0.5	7329	Fig.4-160
39	4895	185	25	193	0.5	7362	Fig.4-162
45	4895	180	25	193	0.5	7331	Fig.4-160
45	4895	185	25	193	0.5	7424	Fig.4-161
39	4895	180	25	193	0.5	7373	Fig.4-162
45	4895	185	25	193	0.5	7336	Fig.4-160
45	4895	185	25	193	0.5	7333	Fig.4-160
45	4895	185	25	193	0.5	7333	Fig.4-160
42	4860	174	20	240	0.5	5810	Fig.4-163
42	4860	174	20	240	0.5	5805	Fig.4-163
39	4867.2	170	24	200	0.5	5313	Fig.4-164
45	5160	180	20	256	0	8552	Fig.4-165
45	5232	183	24	215	0.5	8079	Fig.4-166
45	5440	220	20	270	0	11752	Fig.4-167
52	5488	220	28	193	0.5	11706	Fig.4-168
45	5486.18	213	28	193	0.5	9113	Fig.4-169
45	5419.2	203	24	222	1	7922	Fig.4-170
39	5419.2	202	24	223	0.5	8070	Fig.4-171
48	5650.0	220	25	223	0.5	13078	Fig.4-172
33	5491.2	145	24	226	0.4	6381	Fig.4-173
45	6070	270	25	240	0.5	16722	Fig.4-174

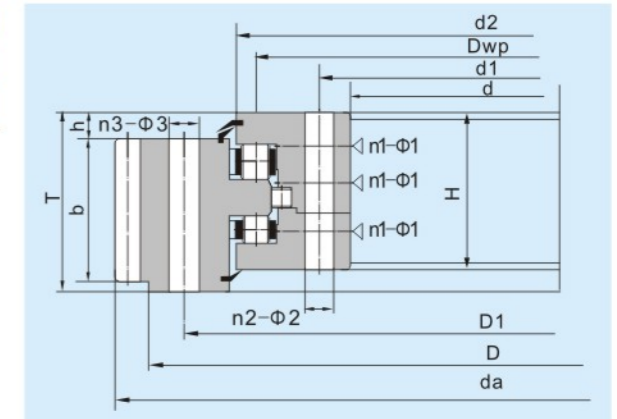



### Three-row Cylindrical Roller Slewing Bearing-without Teeth

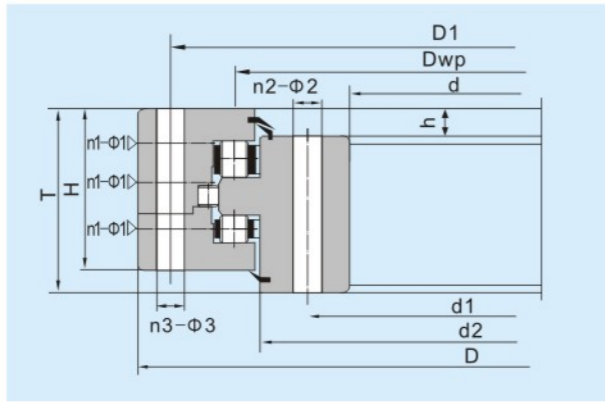

d670~2579mm

Boundary Dimension			Bearing Type	Related Dimension										Weight	Loading Curve		
d	D	T		D1	d1	d2	Dwp	H	h	n1	n2	n3	φ1			φ2	φ3
mm			mm													kg ≈	
670	1000	163	130.25.827.03	948	721	810	834	138	25	6	38	38	M10×1	26	M24	408	Fig.4-48
736	1064	182	130.32.900.03	1020	780	870	900	142	40	6	36	36	M10×1	22	22	507	Fig.4-49
770	1100	163	130.25.933.03	1048	822	909	935	138	30	6	36	36	M10×1	M24	26	455	Fig.4-50
1064	1550	278	5397/1064	1478	1136	1360	1300	278	65	6	36	36	ZG1/4	36	36	1672	Fig.4-51
1405	1795	220	130.40.1600.03	1743	1457	1558	1600	170	30	12	48	48	ZG1/4	26	26	1341	Fig.4-52
1605	1995	220	130.40.1800.03	1943	1657	1760	1801	210	50	12	48	48	ZG1/4	26	26	1516	Fig.4-53
1640	2020	141	5397/1640	1950	1710	1868	1820	1868	29	6	40	40	M10×1	33	33	964	Fig.4-54
1655	2020	136	5397/1655	1950	1725	1872	1836	123	13	10	40	36	M8	33	33	845	Fig.4-55
1655	2020	136	5397/1655K	1950	1725	1872	1836	123	13	10	40	36	M10×1	33	33	848	Fig.4-55
1779	2221	231	130.45.2000.03	2155	1885	1967	2000	219	54	6	60	60	M10×1	33	33	1945	Fig.4-56
1885	2545	315	5397/1885	2445	1985	2310	2215	251	9	8	42	42	G1/4	52	52	4524	Fig.4-57
2000	2500	190	5397/2000	2400	2090	2300	2240	176	14	6	40	40	M10×1	45	45	2048	Fig.4-58
2019	2461	231	130.45.2240.03K	2395	2085	2207	2240	219	54	8	72	72	M10×1	33	33	2146	Fig.4-59
2135	2555	160	5397/2135	2480	2215	2400	2346	128	12	5	50	50	M10×1	40	40	1488	Fig.4-60
2135	2555	214	5397/2135K	2480	2215	2400	2346	202	20	5	50	50	M10×1	40	40	2013	Fig.4-61
2190	2650	154	5397/2190	2560	2280	2446	2400	140	14	6	60	60	ZG1/4	39	39	1600	Fig.4-62
2190	2650	170	5397/2190K	2560	2280	2454	2406	156	14	6	60	60	ZG1/4	39	39	1742	Fig.4-63
2279	2721	231	130.45.2500.04	2655	2345	2555	2500	177	54	8	72	72	ZG1/8	33	33	2488	Fig.4-64
2279	2721	231	130.45.2500.04K	2655	2345	2463	2500	219	54	5	72	72	ZG1/4	33	33	2310	Fig.4-65
2279	2721	231	130.45.2500.04K1	2655	2345	2555	2500	177	12	8	72	72	ZG1/8	33	33	2486	Fig.4-64
2279	2721	231	130.45.2500.12	2655	2345	2555	2500	177	54	8	72	72	ZG1/8	33	33	2480	Fig.4-64
2360	2880	248	5397/2360	2800	2440	2680	2612	196	52	10	60	60	ZG1/4	39	39	3215	Fig.4-66
2422	2805	158	5397/2422	2740	2488	2600	2625	128	30	8	52	52	ZG1/4	33	33	1561	Fig.4-67
2450	3087	340	5397/2450	2983	2554	2814	2743	290	50	24	60	60	G1/4	52	52	5774	Fig.4-67
2460	2805	132	5397/2460	2740	2525	2610	2638	107	25	12	48	48	ZG1/4	33	33	1162	Fig.4-69
2470	3070	220	130.40.2790.03	2960	2580	2740	2794	211	50	8	48	48	ZG1/4	51	51	3535	Fig.4-70
2470	2940	200	5397/2470	2860	2550	2758	2706	186	14	12	60	60	ZG1/4	45	45	2485	Fig.4-71
2470	3020	213	5397/2470K	2920	2570	2798	2787	173	13	8	48	48	ZG1/4	45	45	3122	Fig.4-72
2508	2900	180	130.36.2700.03	2836	2578	2750	2703	140	10	8	72	72	G1/4	34	34	1810	Fig.4-73
2508	2900	180	130.36.2700.03K	2836	2578	2750	2703	140	10	8	72	72	G1/4	34	34	1785	Fig.4-73
2508	2900	180	130.36.2700.04	2836	2578	2750	2703	140	10	8	72	72	G1/4	34	34	1784	Fig.4-73
2579	3021	231	130.45.2800.03	2955	2645	2866	2800	177	12	8	72	72	ZG1/4	33	33	2750	Fig.4-74
2579	3021	231	130.45.2800.03K	2955	2645	2767	2800	219	54	8	72	72	M10×1	33	33	2751	Fig.4-75
2579	3021	231	130.45.2800.04	2955	2645	2866	2800	177	12	8	72	72	ZG1/4	33	33	2750	Fig.4-74
2579	3021	231	130.45.2800.12	2955	2645	2855	2800	177	54	8	72	72	ZG1/4	33	33	2706	Fig.4-74

d2839~4680mm

Boundary Dimension			Bearing Type	Related Dimension										Weight	Loading Curve		
d	D	T		D1	d1	d2	Dwp	H	h	n1	n2	n3	φ1			φ2	φ3
mm			mm													kg ≈	
2839	3266	158	5397/2839	3200	2905	3058	3082	149	30	9	68	68	ZG1/4	33	33	2016	Fig.4-76
2839	3266	195	5397/2839K	3200	2905	3035	3059	184	45	11	68	68	ZG1/4	33	33	2447	Fig.4-77
2868	3432	270	130.50.3150.12K	3342	2958	3103	3150	258	50	8	72	72	M10×1	45	45	4900	Fig.4-78
2868	3432	270	130.50.3150.12K1	3342	2958	3103	3150	258	50	5	72	72	ZG1/8	45	45	4900	Fig.4-78
2868	3432	270	130.50.3150.12K2	3342	2958	3213	3150	205	65	8	72	72	M10×1	45	45	4400	Fig.4-79
2992	3376	155	130.25.3186.03	3310	3057	3162	3186	145	30	8	60	60	ZG1/4	33	33	2143	Fig.4-80
3212	3694	210	130.40.3460.03	3616	3290	3427	3460	201	9	9	72	72	ZG1/4	39	39	3385	Fig.4-81
3268	3832	270	130.50.3550.03	3742	3358	3613	3550	205	65	8	72	72	M10×1	45	45	4700	Fig.4-82
3268	3832	270	130.50.3550.03K	3742	3358	3613	3550	205	65	8	72	72	M10×1	45	45	4721	Fig.4-82
3268	3832	270	130.50.3550.03K1	3742	3358	3613	3550	205	65	8	72	72	M10×1	45	45	4721	Fig.4-82
3268	3832	270	130.50.3550.03K2	3742	3358	3613	3550	205	65	8	72	72	ZG1/4	45	45	4721	Fig.4-82
3268	3832	270	130.50.3550.04	3742	3358	3613	3550	205	65	8	72	72	M10×1	45	45	4700	Fig.4-82
3268	3832	270	130.50.3550.12	3742	3358	3613	3550	205	65	8	72	72	M10×1	45	45	4700	Fig.4-82
3312	3840	220	130.40.3550.03	3745	3390	3602	3550	170	50	10	60	60	M10×1	39	39	4163	Fig.4-83
3312	3824	220	130.40.3550.03K	3746	3390	3602	3550	170	50	11	66	66	M10×1	39	39	4024	Fig.4-84
3370	3832	192	5397/3370	3754	3448	3646	3589	180	44	8	96	96	M10×1	39	39	3033	Fig.4-85
3560	4100	275	5397/3560	4010	3660	3908	3842	260	15	9	72	72	ZG1/4	45	45	5520	Fig.4-86
3650	4300	355	3-931G	4210	3750	3850	3950	355	0	18	90	90	M16×1.5	48	48	9503	Fig.4-87
3735	4290	268	5397/3735	4200	3825	3977	4025	258	65	9	60	60	G1/4	45	45	5865	Fig.4-88
3998	4500	254	130.45.4240.03	4420	4078	4302	4240	197	57	10	80	80	M10×1	45	45	5154	Fig.4-89
4168	4717	276.225	130.50.4435.03	4625	4260	4515	4435	206.4	18.2	6	72	72	ZG1/4	45	45	6414	Fig.4-90
4218	4782	270	130.50.4500.04	4692	4308	4454	4500	258	65	8	80	80	M10×1	45	45	6942	Fig.4-91
4235	4850	268	5397/4235	4700	4325	4560	4500	258	65	11	68	68	ZG1/4	45	45	7178	Fig.4-92
4680	5333	305	5397/4680	5136	4774	5023	4950	293	58	18	90	90	ZG1/4	45	45	9772	Fig.4-93



Loading Curve

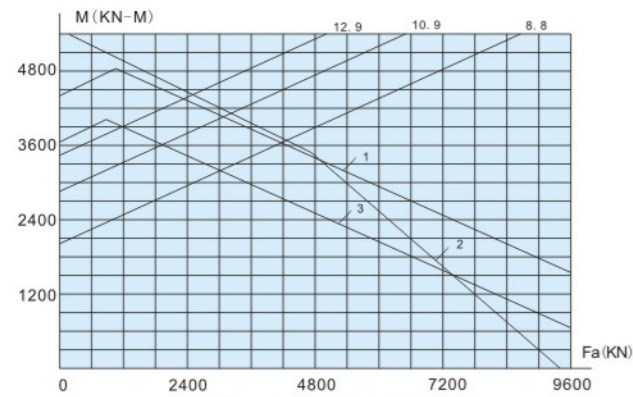

Fig. 4-1 7397/1500

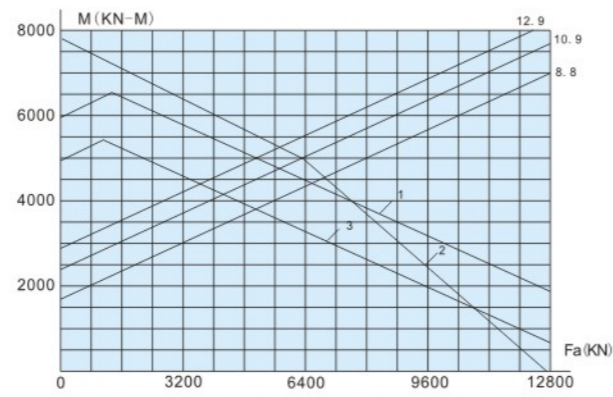

Fig. 4-2 133.40.1800.12K

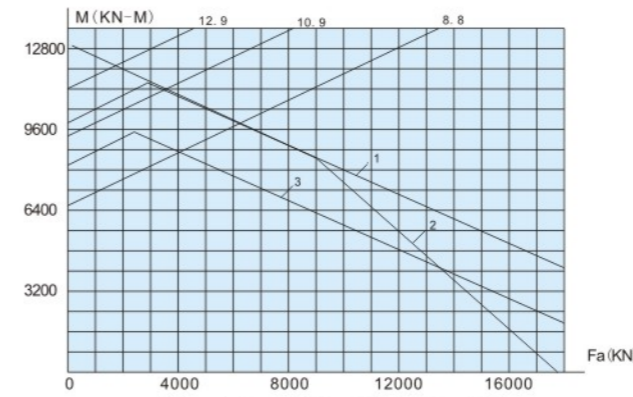

Fig. 4-9 133.45.2240.03K

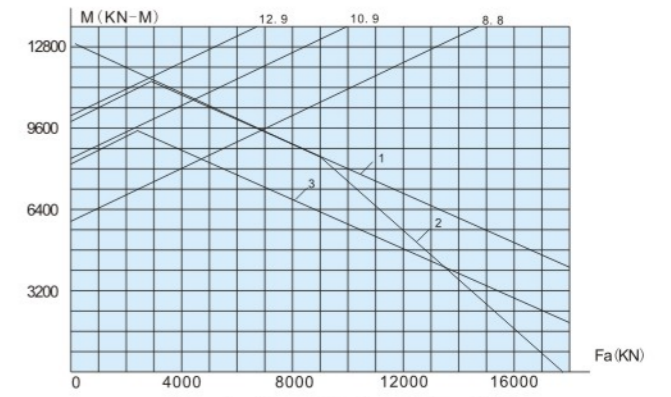

Fig. 4-10 133.45.2240.03K1

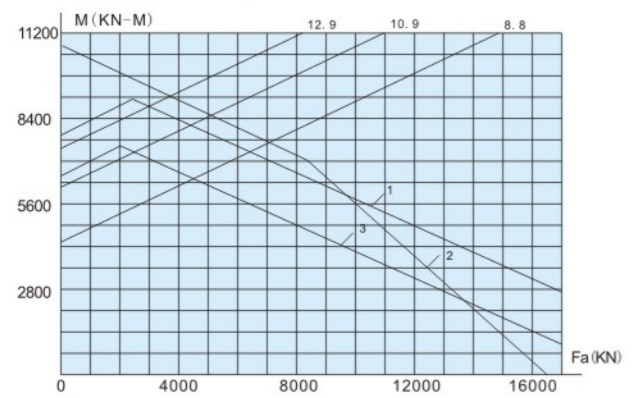

Fig. 4-3 133.45.2000.03K

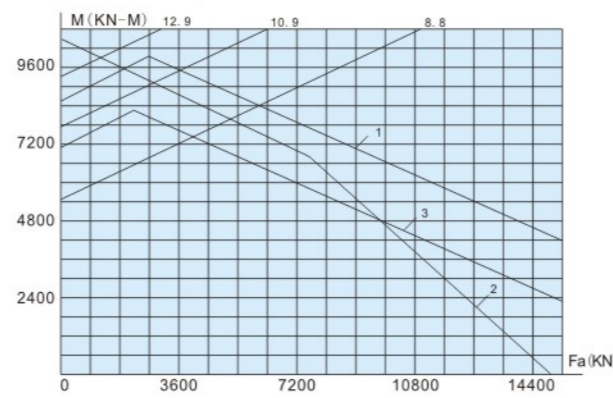

Fig. 4-4 7397/1833

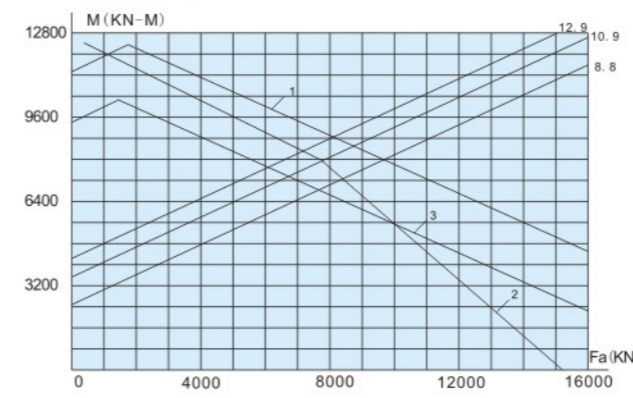

Fig. 4-11 7397/2216K

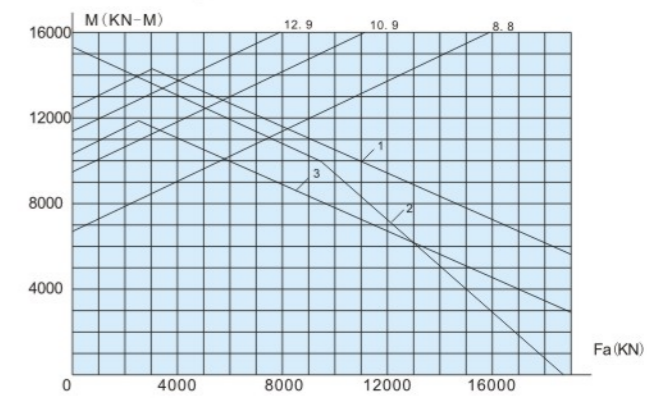

Fig. 4-12 133.45.2500.03K4

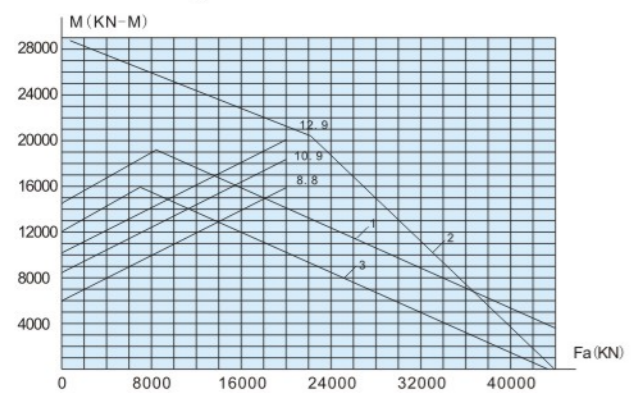

Fig. 4-5 133.90.2245.03

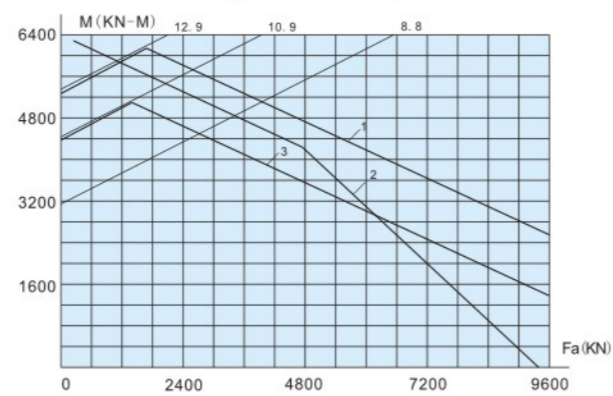

Fig. 4-6 133.30.2130.03

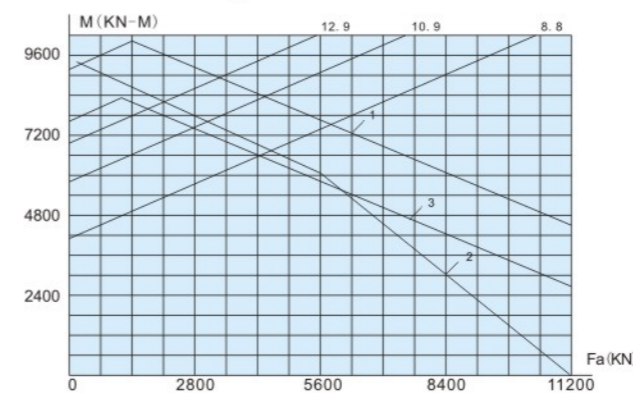

Fig. 4-13 7397/2178

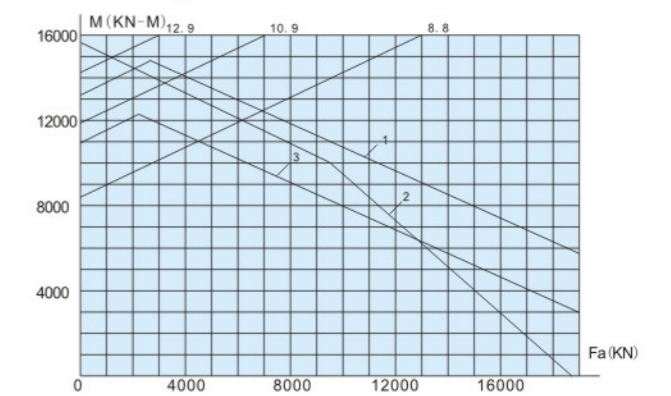

Fig. 4-14 133.45.2500.03K

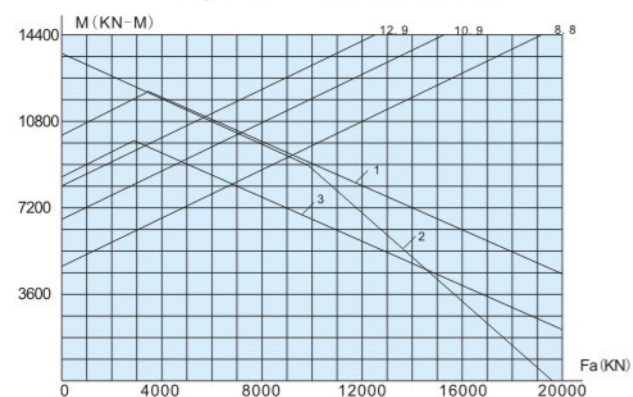

Fig. 4-7 133.45.2150.03

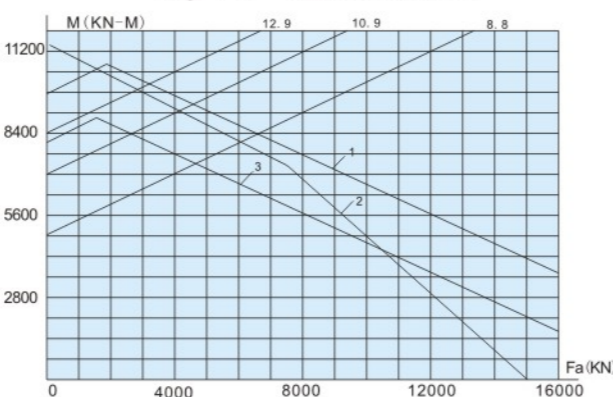

Fig. 4-8 134.40.2234.03

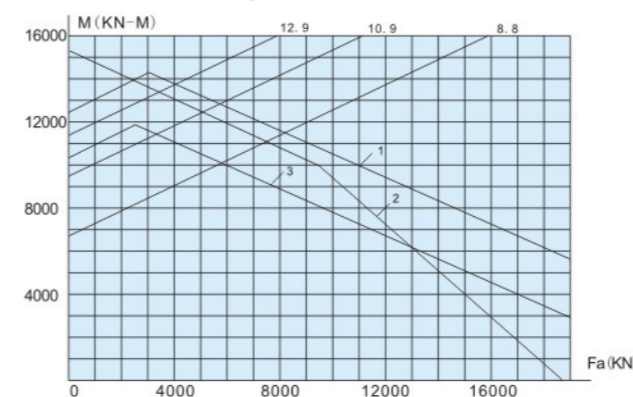

Fig. 4-15 133.45.2500.03K3

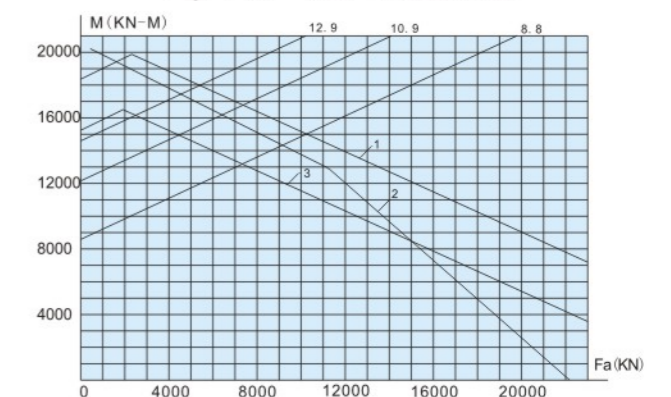

Fig. 4-16 133.50.2694.03



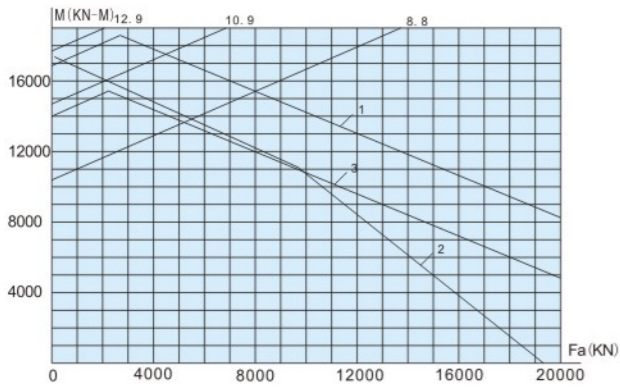

Fig. 4-17 7397/2398

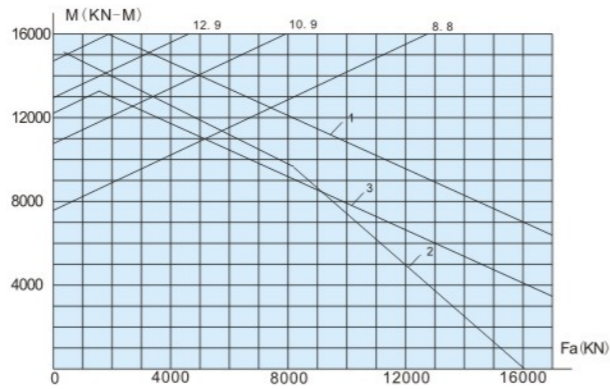

Fig. 4-18 133. 40. 2794. 03

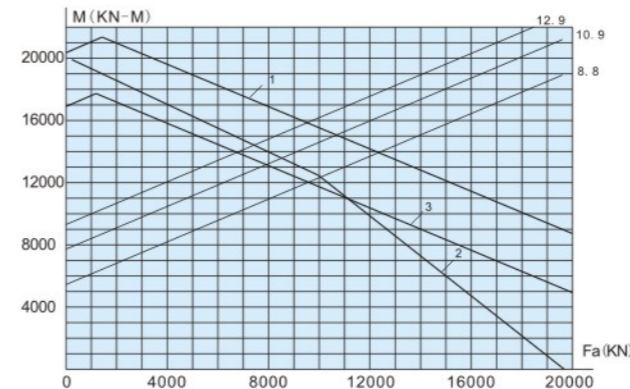

Fig. 4-25 7397/2700K

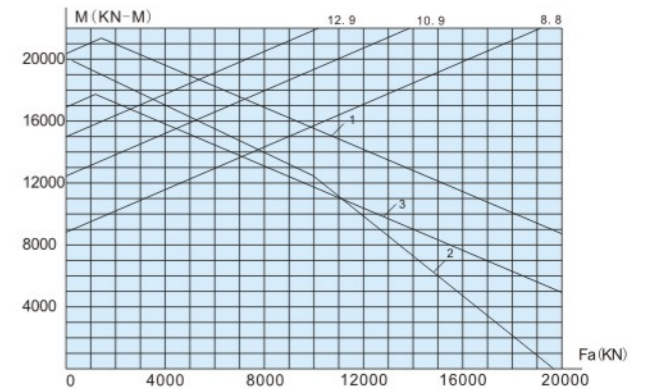

Fig. 4-26 7397/2700GK1

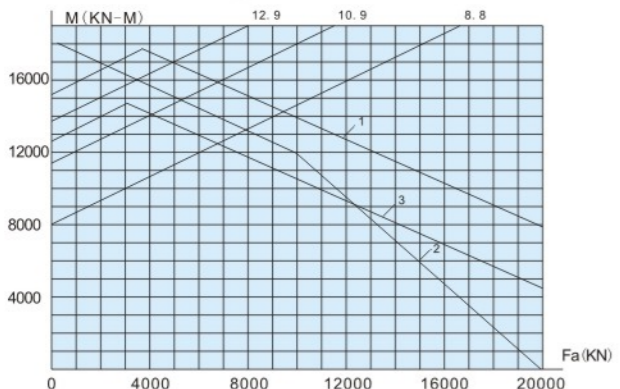

Fig. 4-19 7397/2480

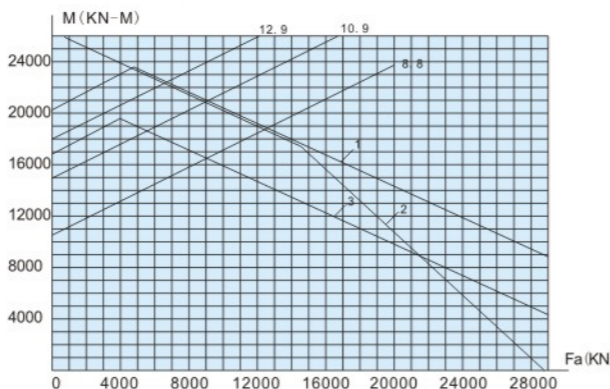

Fig. 4-20 7397/2570K1

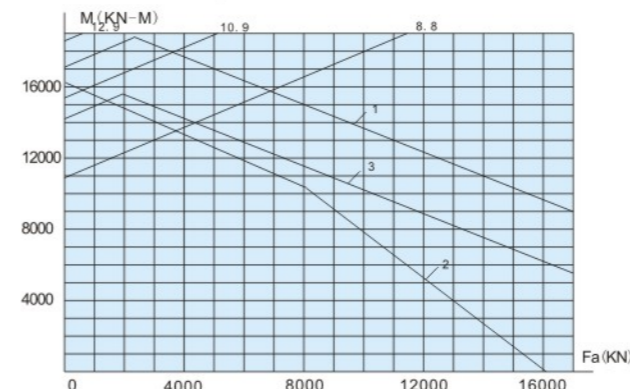

Fig. 4-27 133. 35. 2956. 03

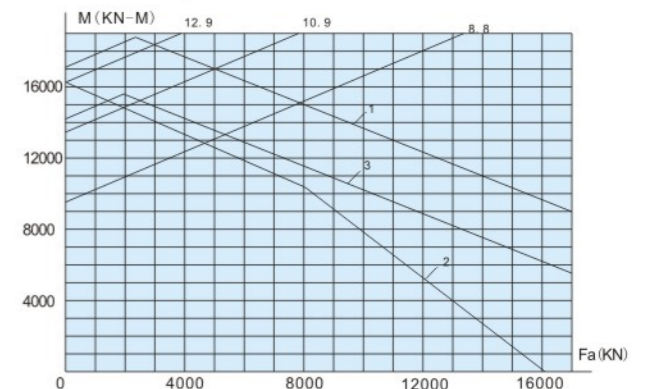

Fig. 4-28 133. 35. 2956. 03K

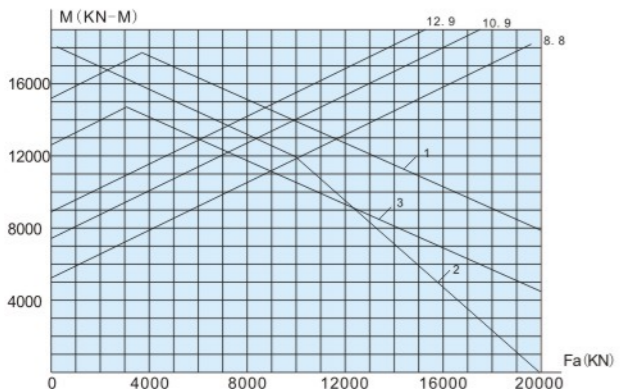

Fig. 4-21 133. 45. 2800. 03

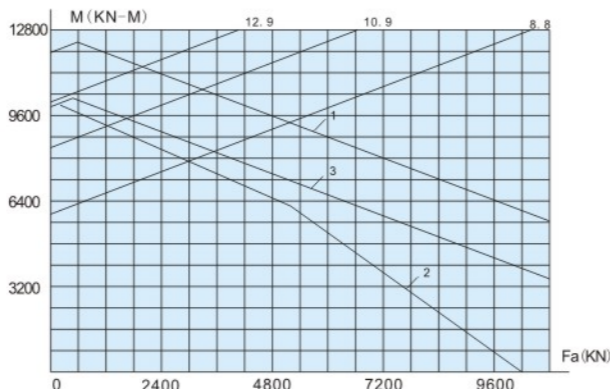

Fig. 4-22 7397/2506

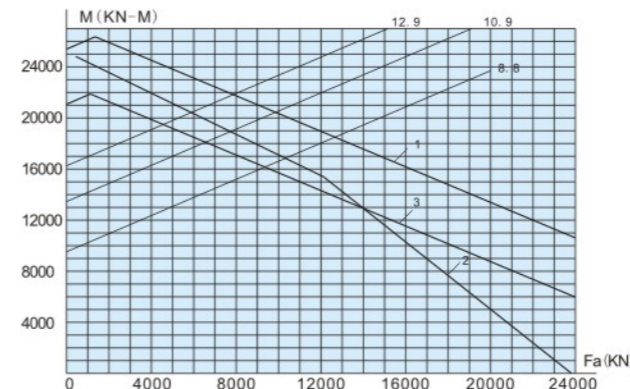

Fig. 4-29 134. 50. 2958. 03

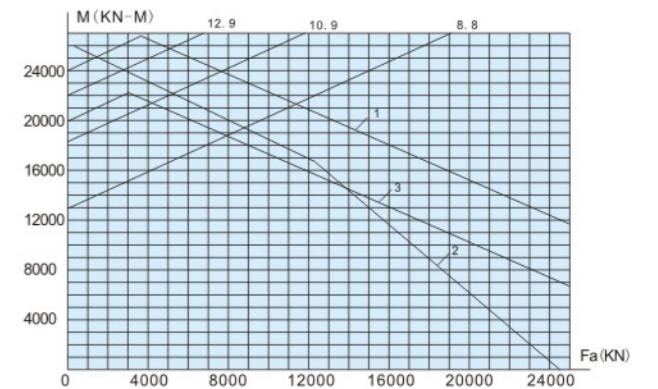

Fig. 4-30 7397/2850

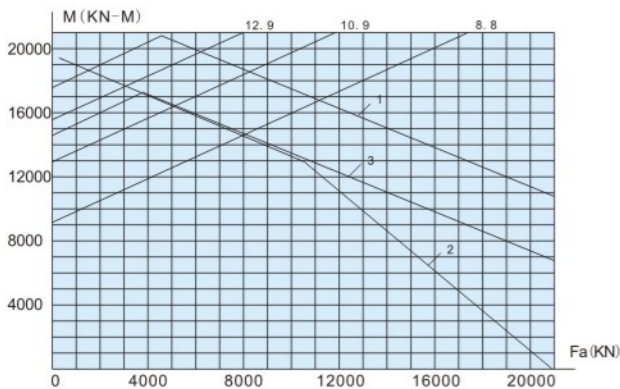

Fig. 4-23 7397/2520

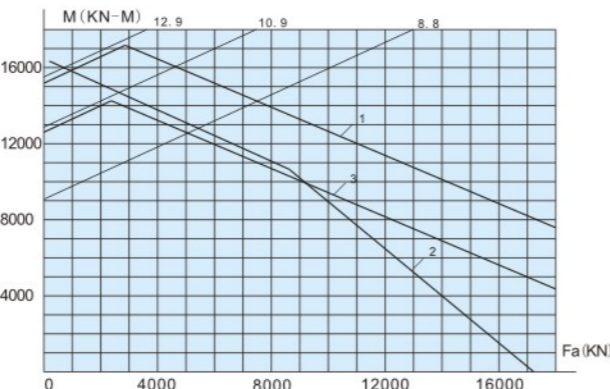

Fig. 4-24 7397/2560

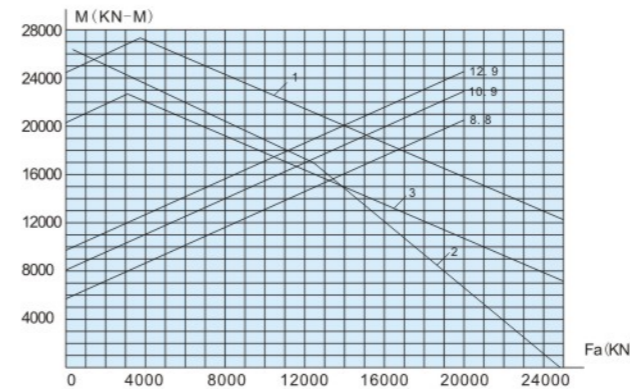

Fig. 4-31 7397/2860

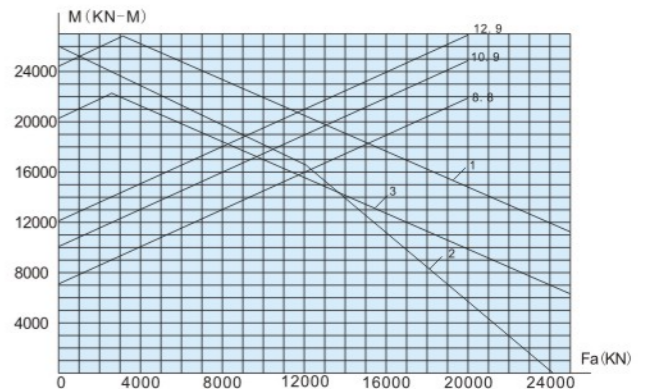

Fig. 4-32 133. 50. 3150. 03



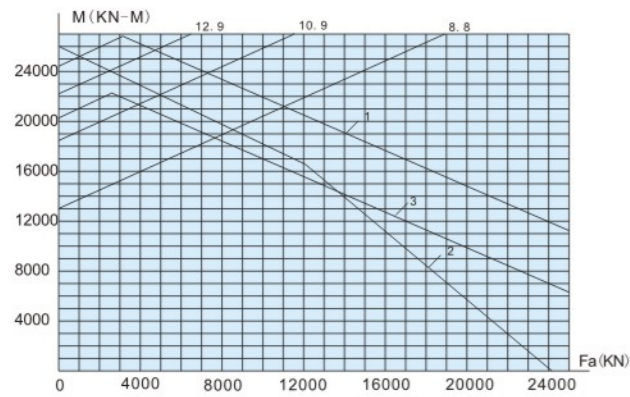

Fig. 4-33 133.50.3150.03K

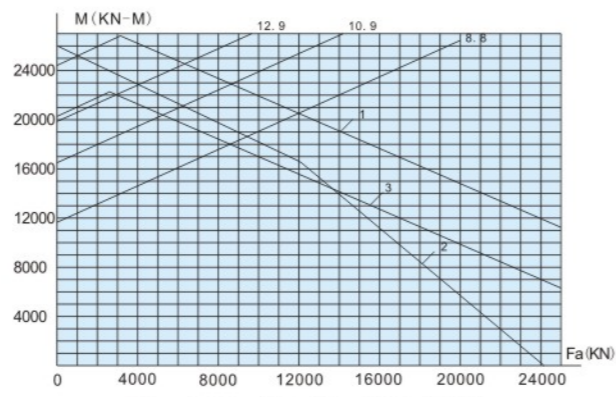

Fig. 4-34 133.50.3150.03K1

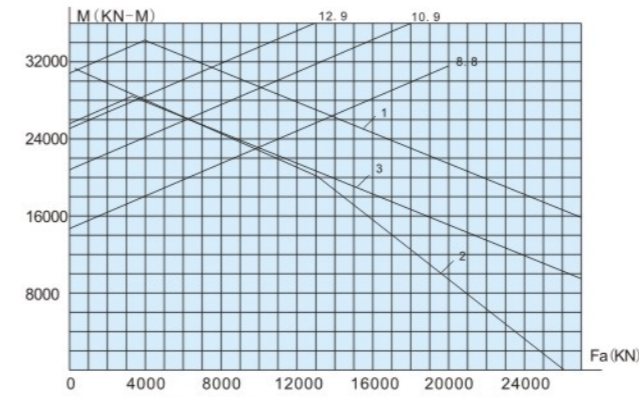

Fig. 4-41 133.50.3550.03K1

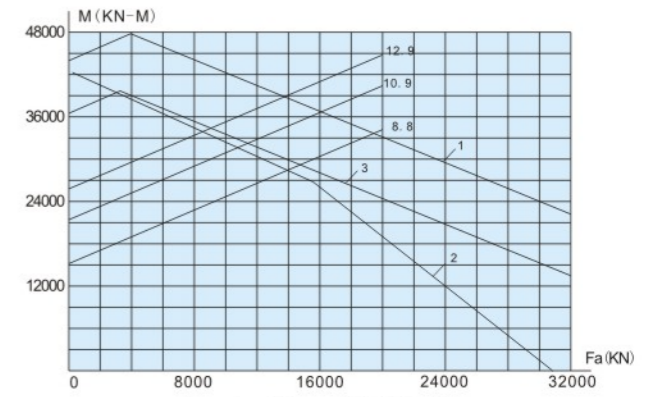

Fig. 4-42 7397/3576

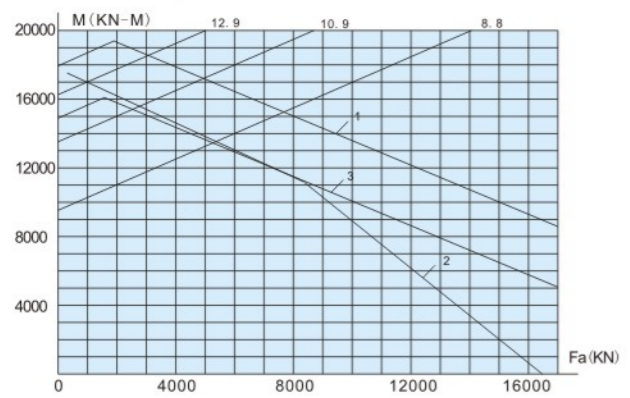

Fig. 4-35 133.40.3145.03

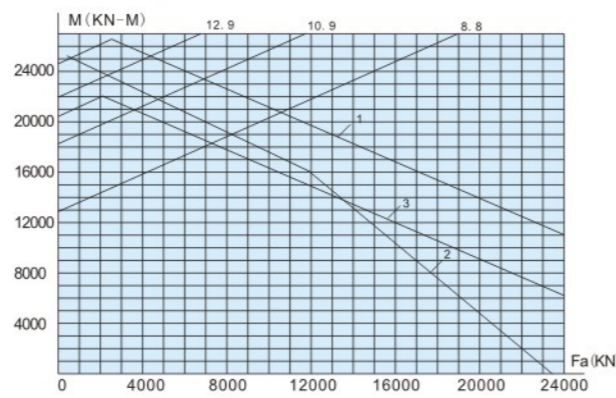

Fig. 4-36 134.50.3173.03

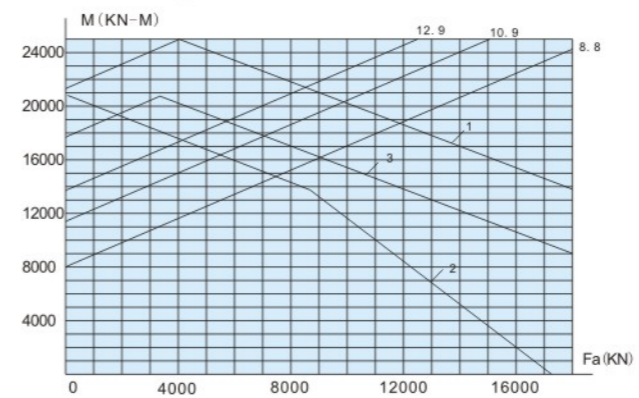

Fig. 4-43 133.40.3740.03

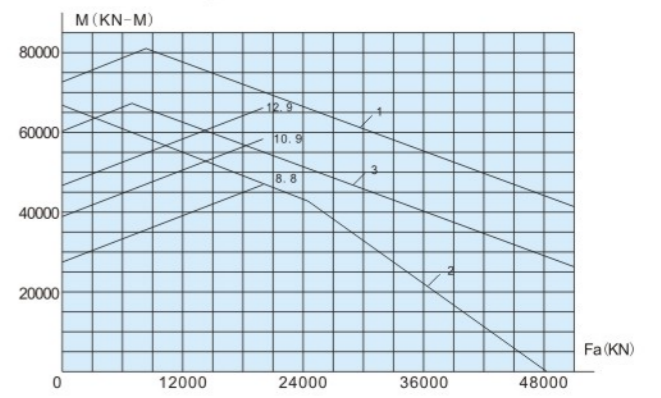

Fig. 4-44 133.60.4130.03

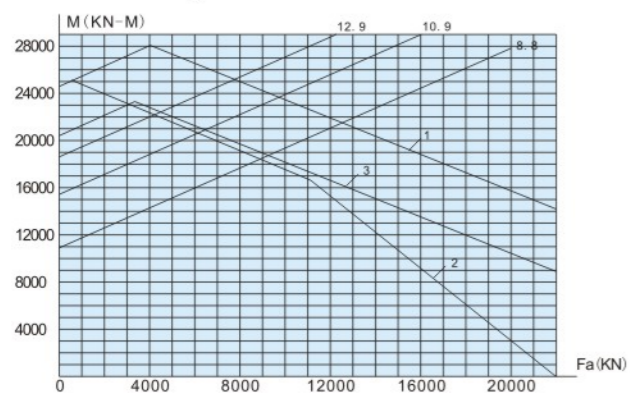

Fig. 4-37 133.45.3550.04

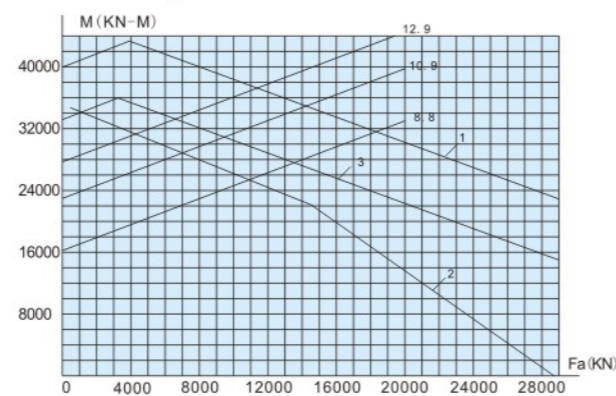

Fig. 4-38 133.45.3560.03

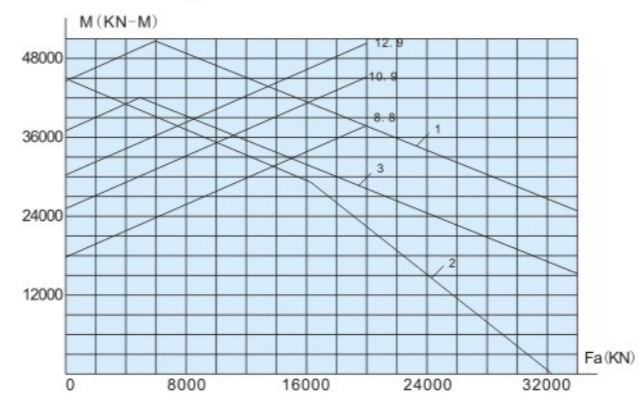

Fig. 4-45 7397/3900

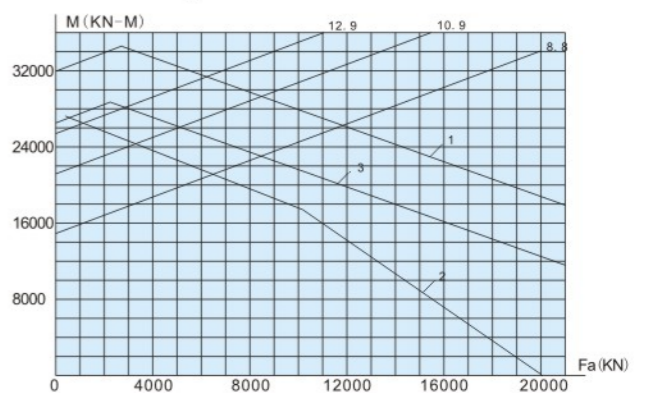

Fig. 4-46 7397/3630

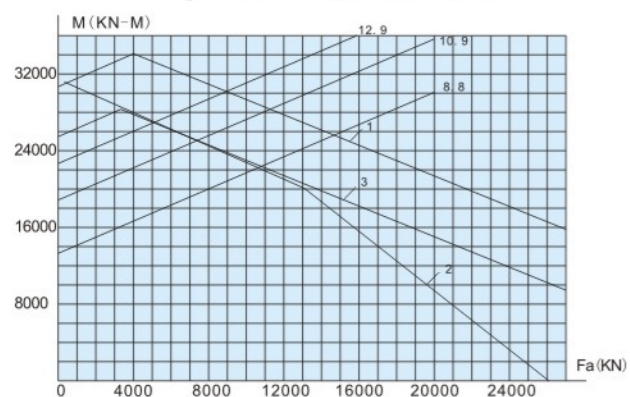

Fig. 4-39 133.50.3550.03K

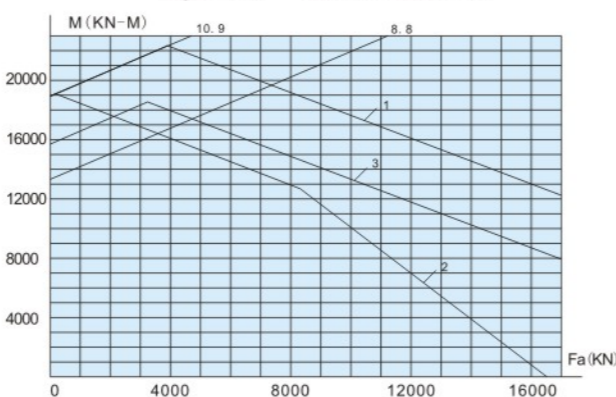

Fig. 4-40 133.36.3610.03

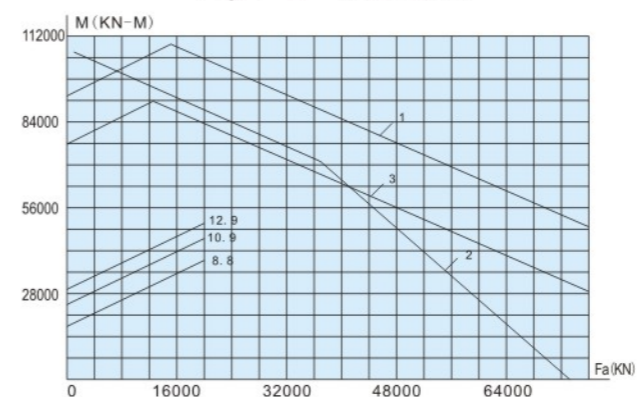

Fig. 4-47 3-945G2

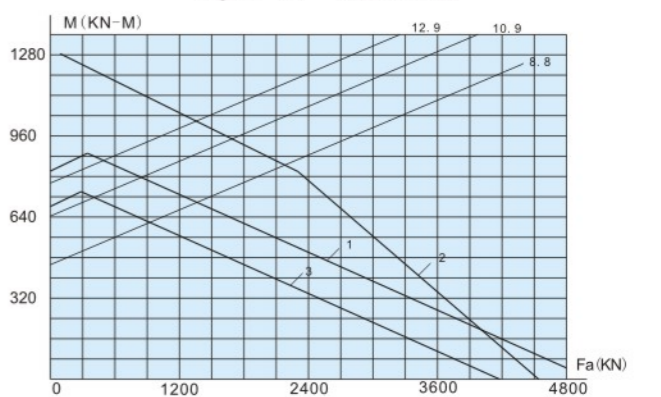

Fig. 4-48 130.25.827.03



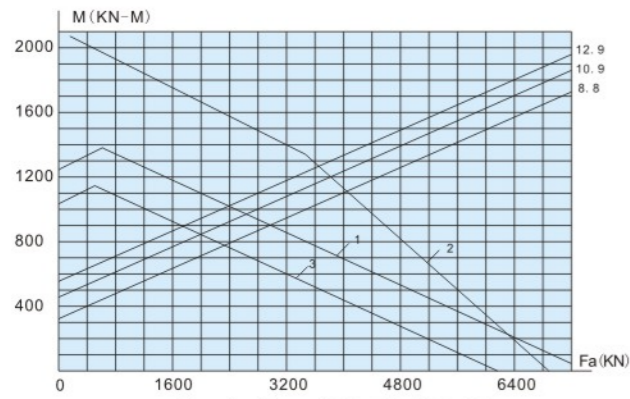

Fig. 4-49 130.32.900.03

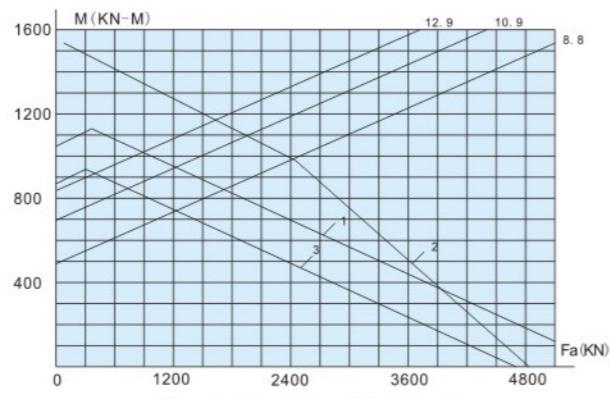

Fig. 4-50 130.25.933.03

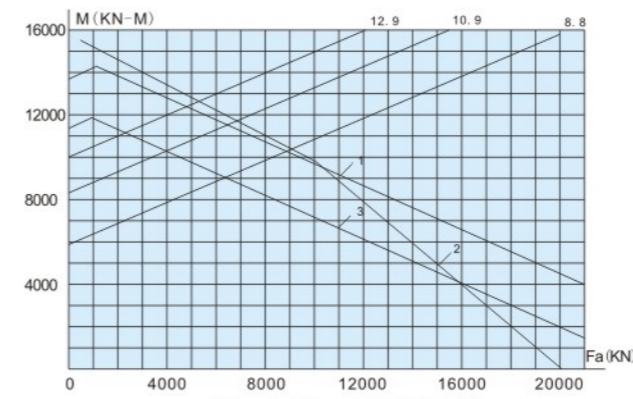

Fig. 4-57 5397/1885

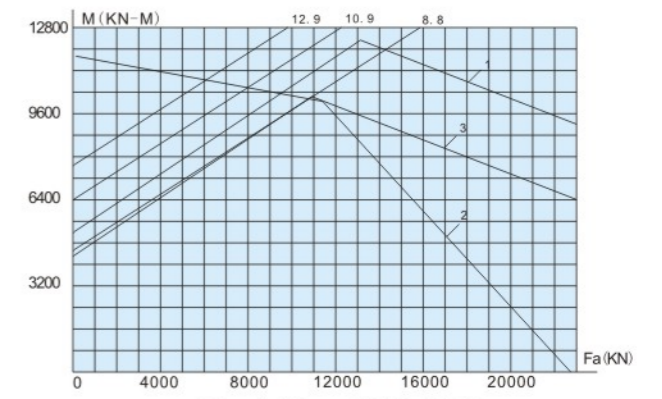

Fig. 4-58 5397/2000

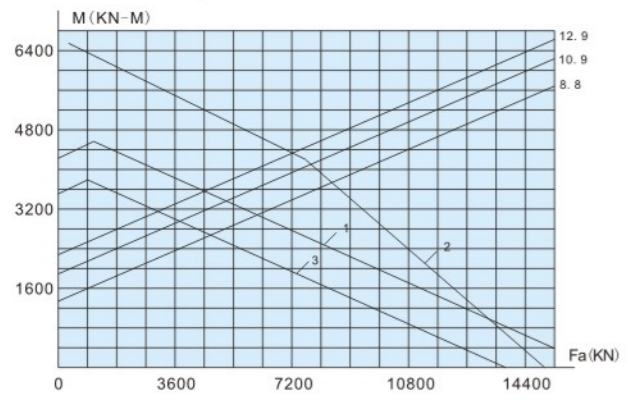

Fig. 4-51 5397/1064

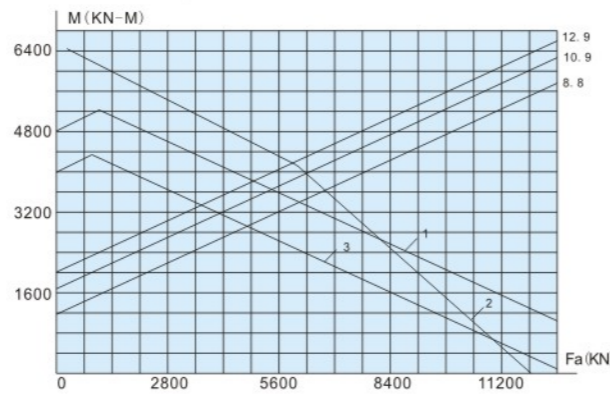

Fig. 4-52 130.40.1600.03

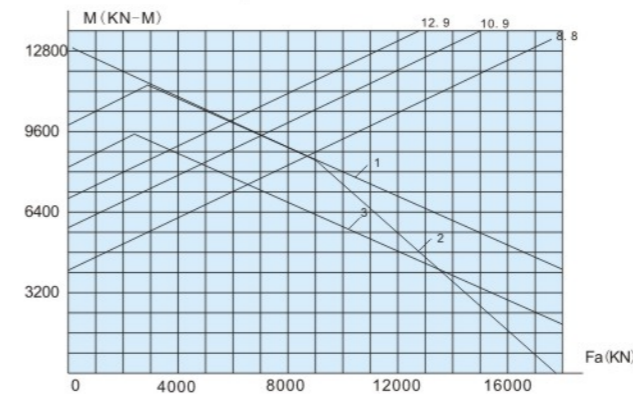

Fig. 4-59 130.45.2240.03K

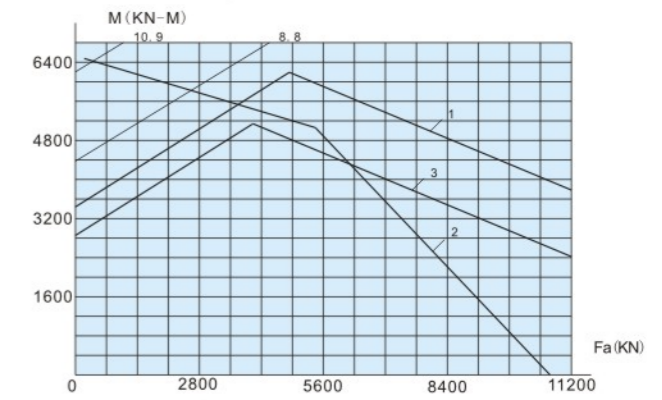

Fig. 4-60 5397/2135

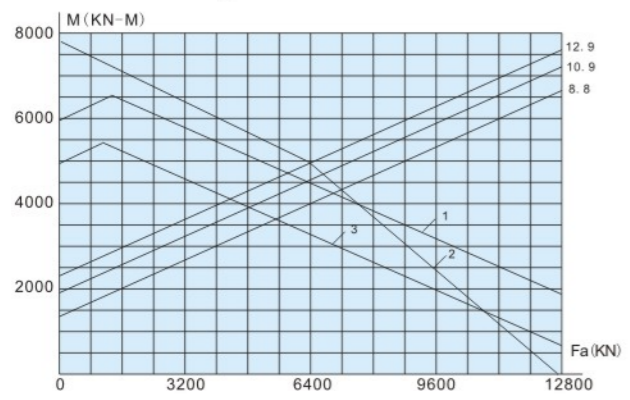

Fig. 4-53 130.40.1800.03

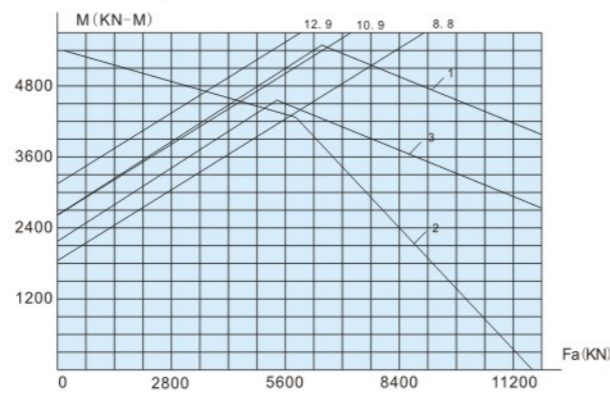

Fig. 4-54 5397/1640

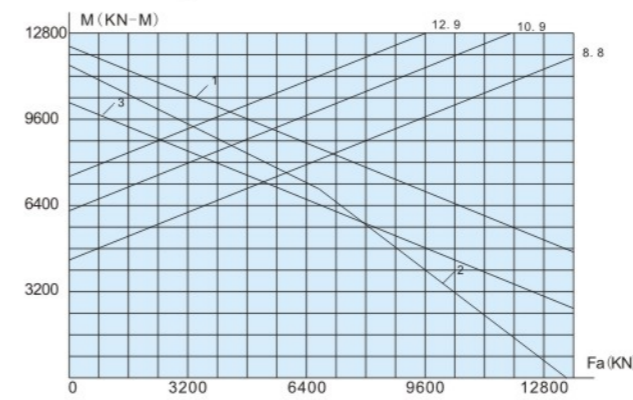

Fig. 4-61 5397/2135K

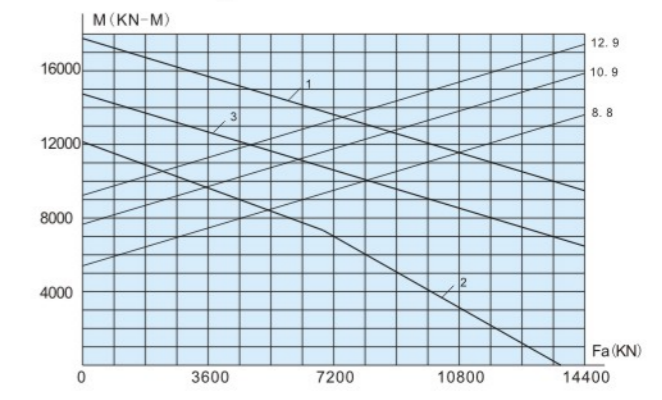

Fig. 4-62 5397/2190

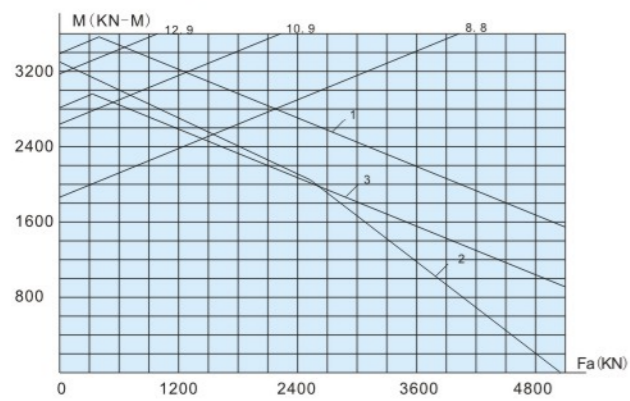

Fig. 4-55 5397/1655

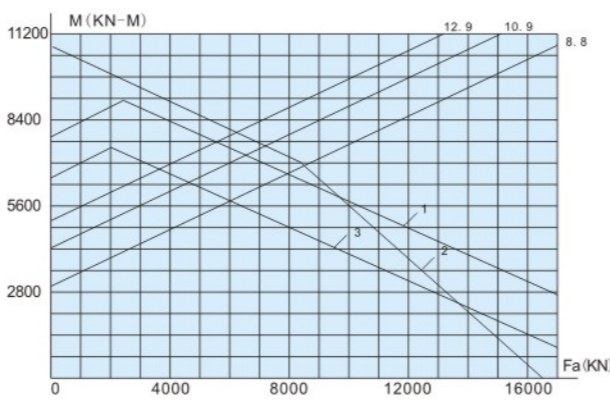

Fig. 4-56 130.45.2000.03

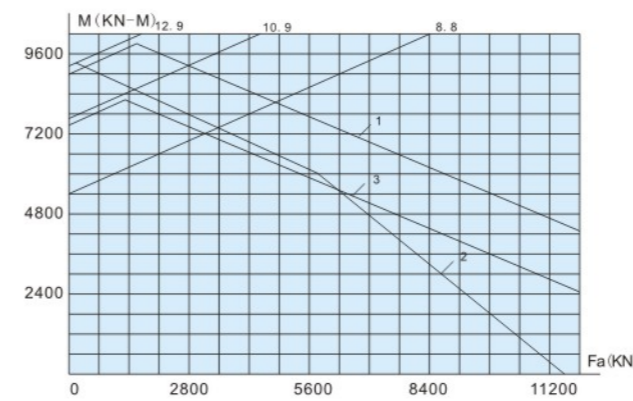

Fig. 4-63 5397/2190K

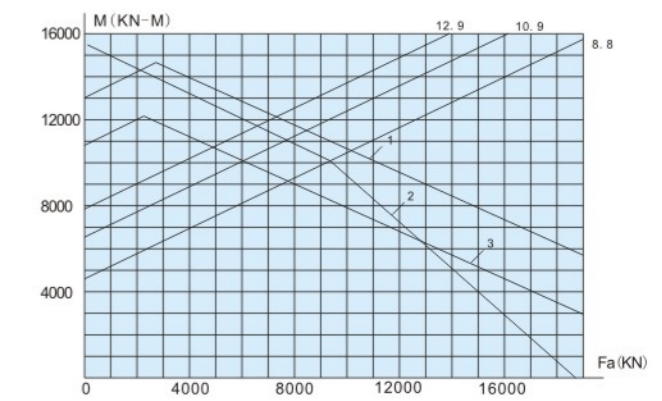

Fig. 4-64 130.45.2500.04



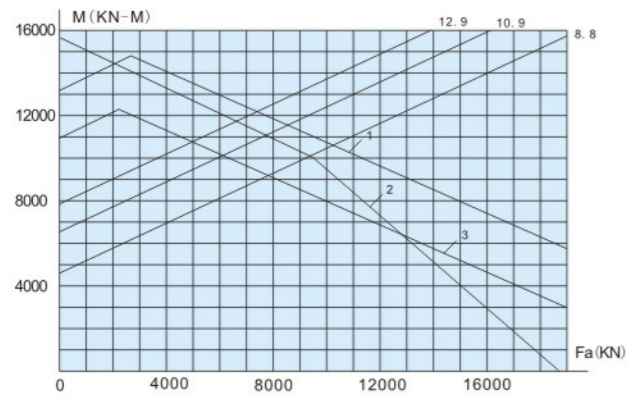

Fig. 4-65 130.45.2500.04K

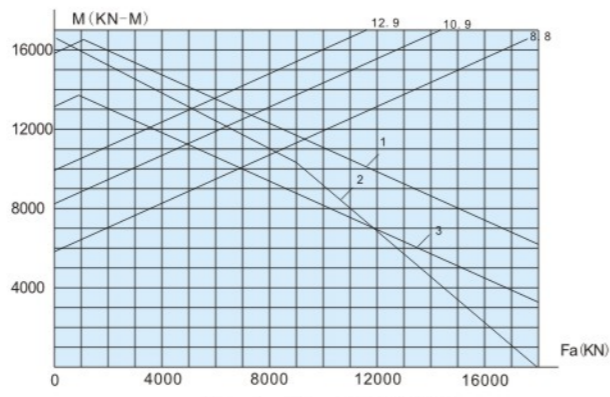

Fig. 4-66 5397/2360

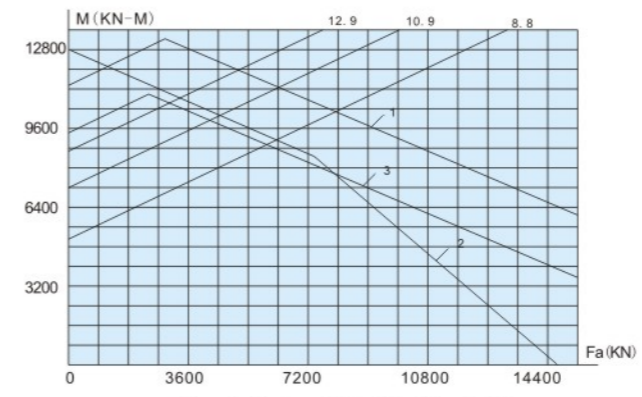

Fig. 4-73 130.36.2700.03

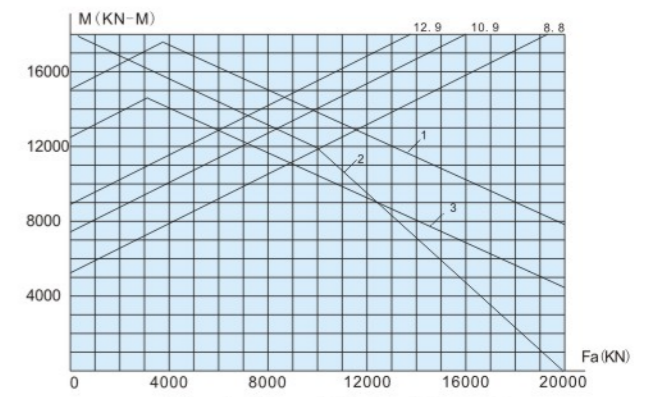

Fig. 4-74 130.45.2800.03

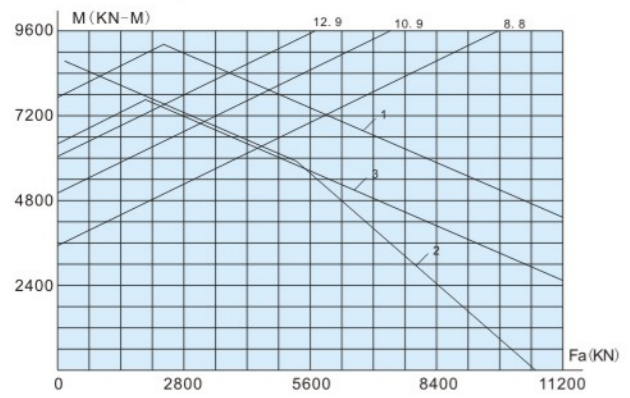

Fig. 4-67 5397/2422

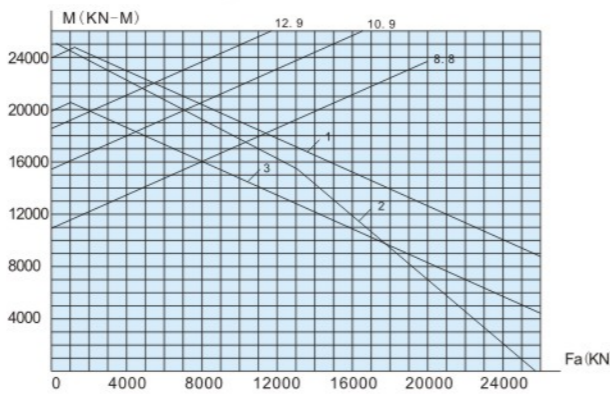

Fig. 4-68 5397/2450

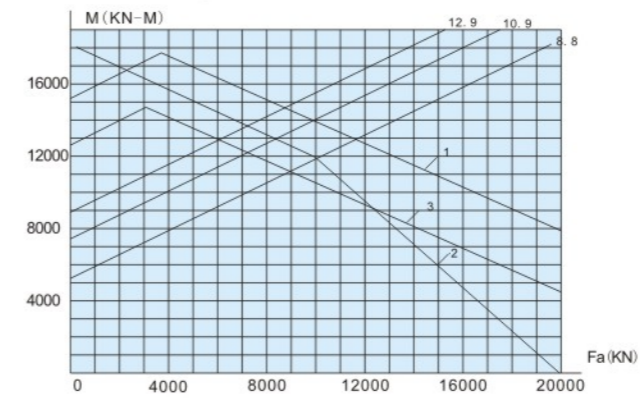

Fig. 4-75 130.45.2800.03K

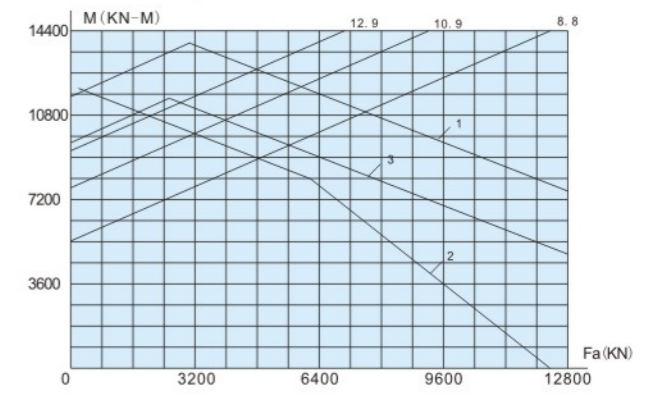

Fig. 4-76 5397/2839

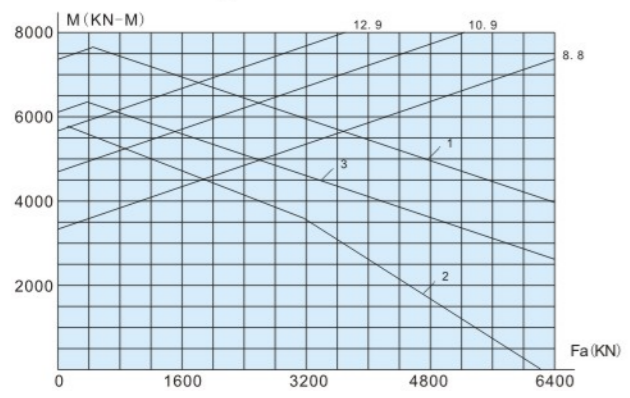

Fig. 4-69 5397/2460

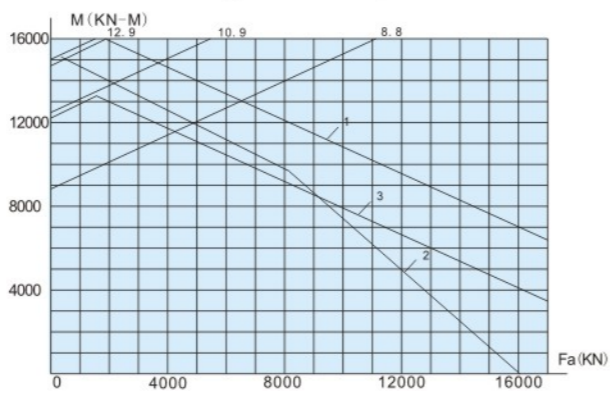

Fig. 4-70 130.40.2790.03

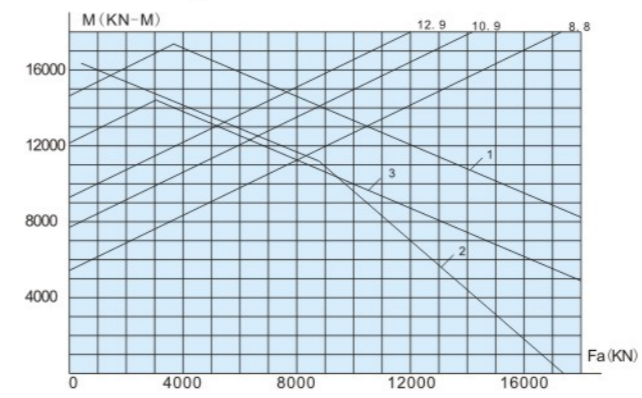

Fig. 4-77 5397/2839K

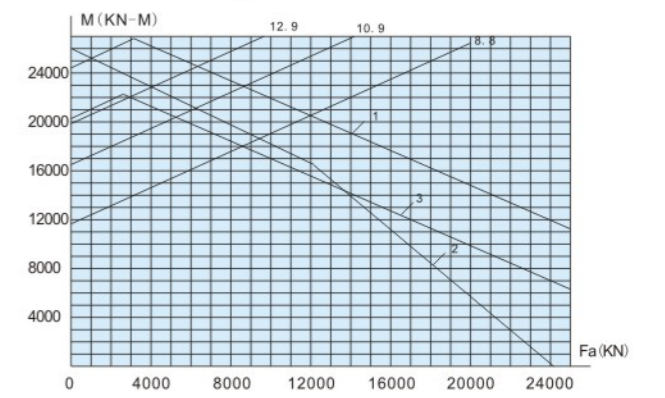

Fig. 4-78 130.50.3150.12K

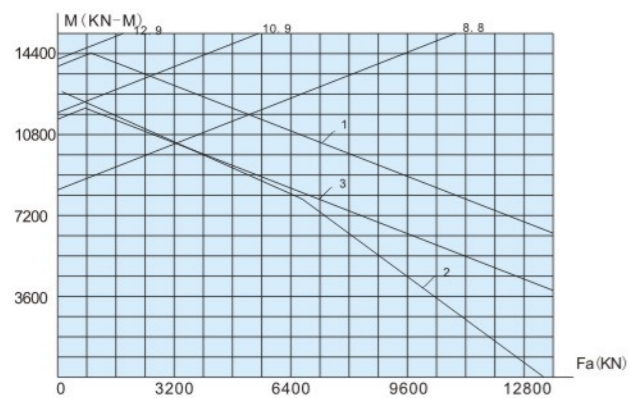

Fig. 4-71 5397/2470

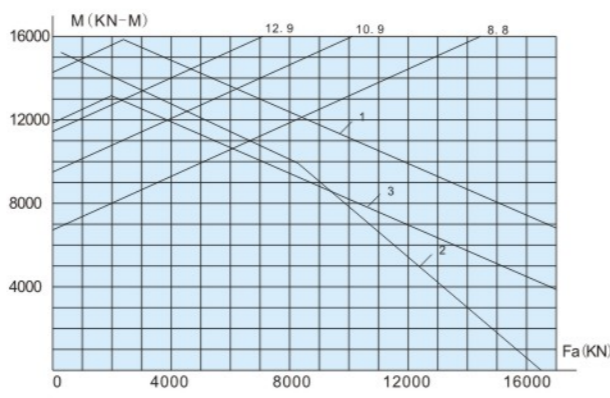

Fig. 4-72 5397/2470K

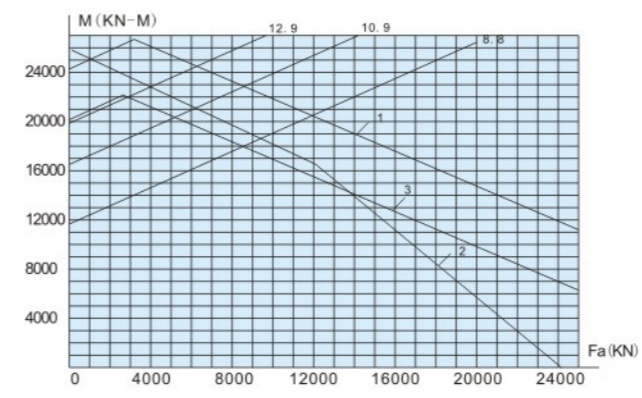

Fig. 4-79 130.50.3150.12K2

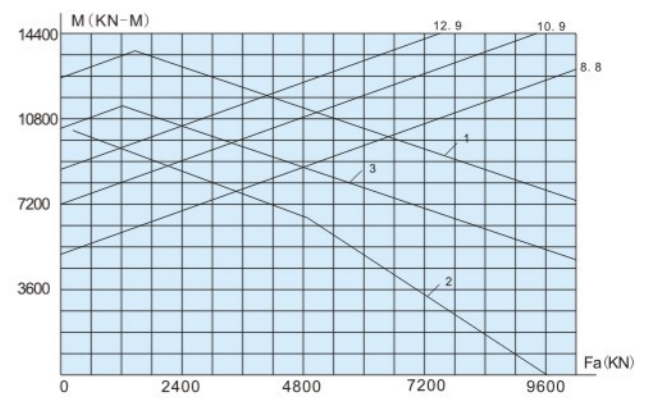

Fig. 4-80 130.25.3186.03



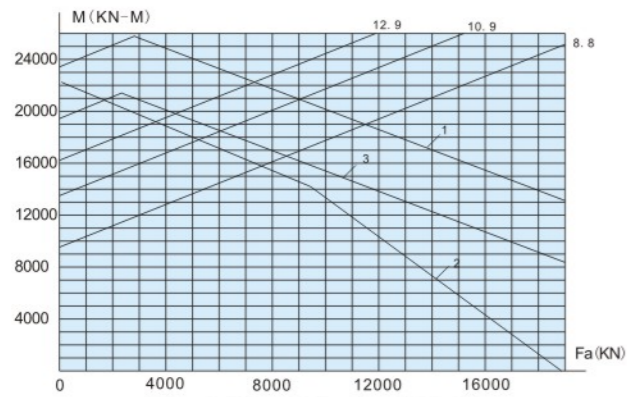

Fig. 4-81 130.40.3460.03

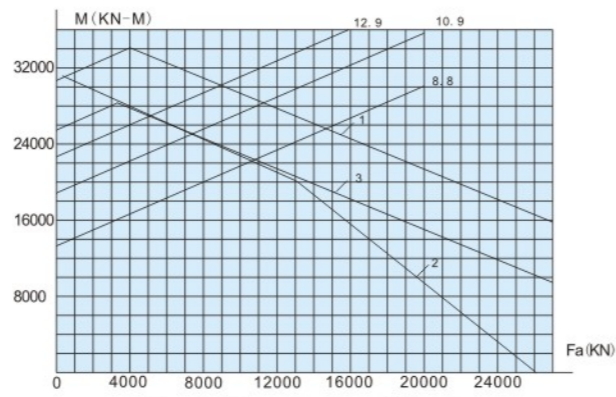

Fig. 4-82 130.50.3550.03

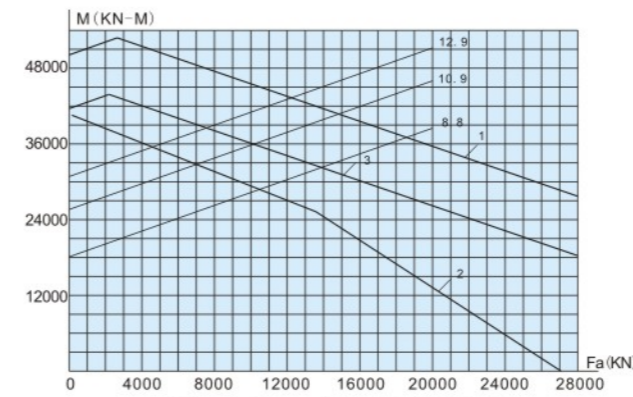

Fig. 4-89 130.45.4240.03

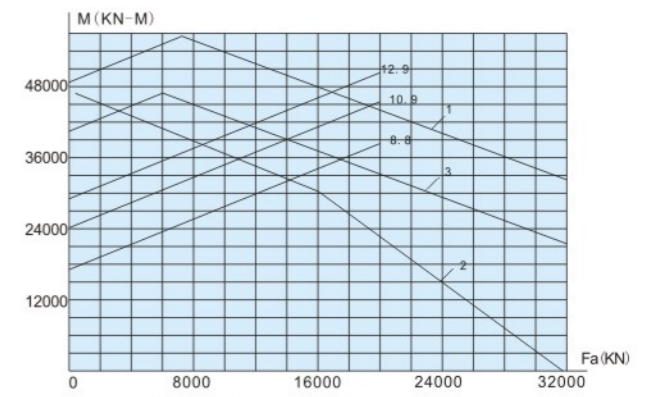

Fig. 4-90 130.50.4435.03

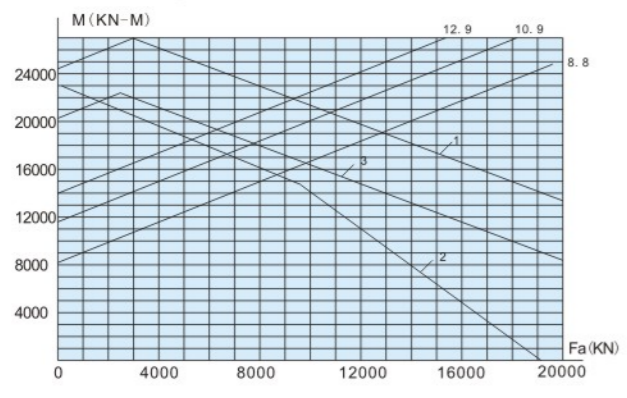

Fig. 4-83 130.40.3550.03

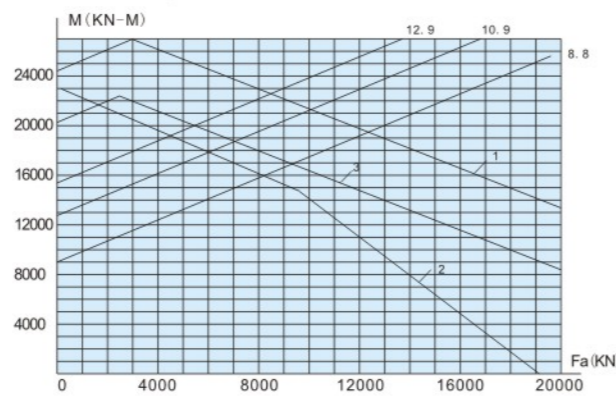

Fig. 4-84 130.40.3550.03K

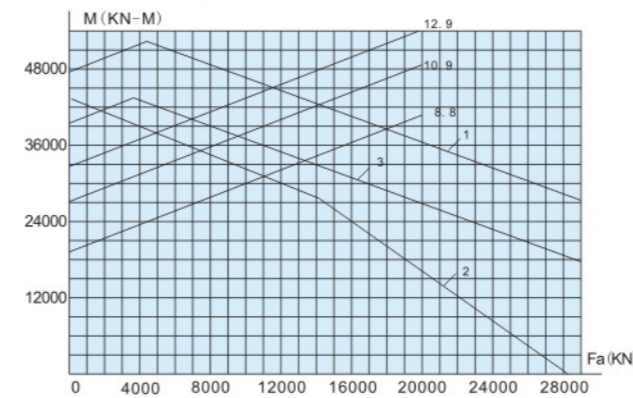

Fig. 4-91 130.50.4500.04

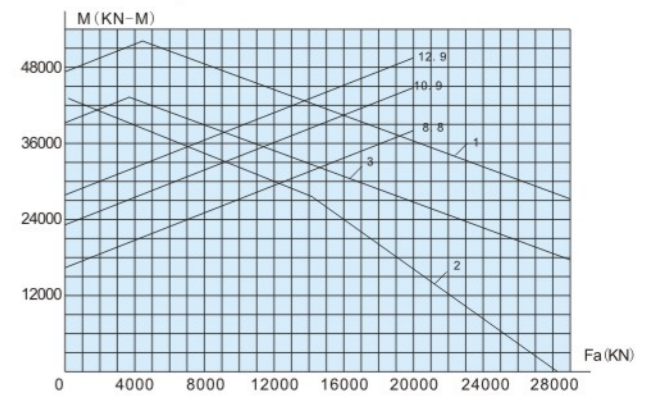

Fig. 4-92 5397/4235

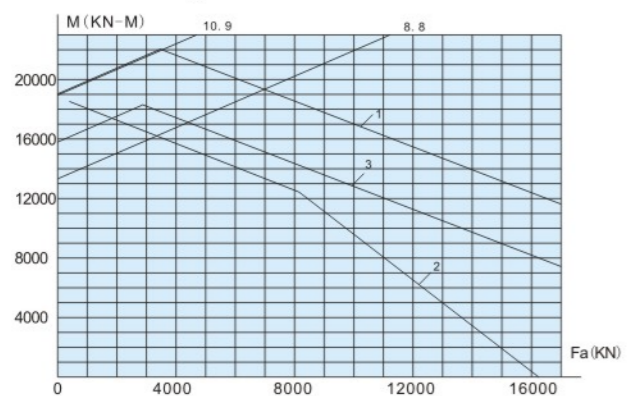

Fig. 4-85 5397/3370

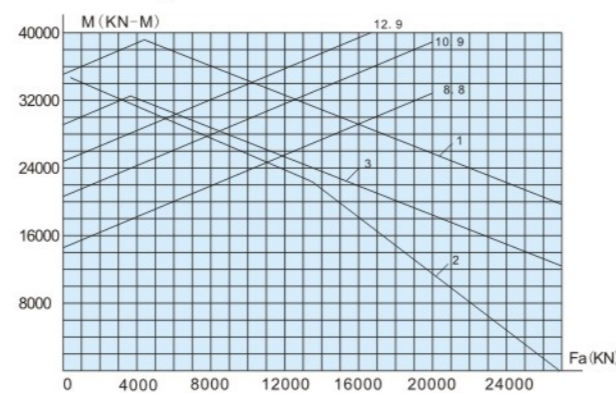

Fig. 4-86 5397/3560

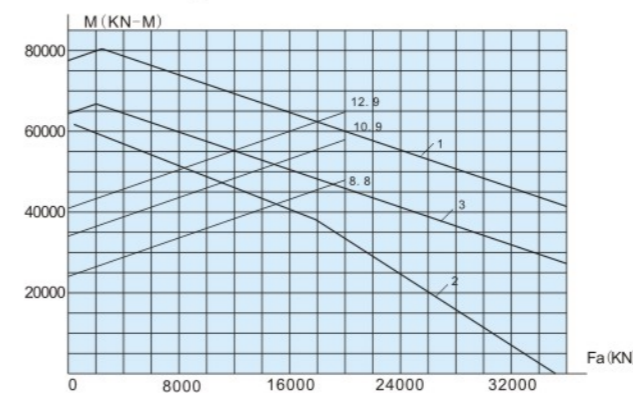

Fig. 4-93 5397/4680

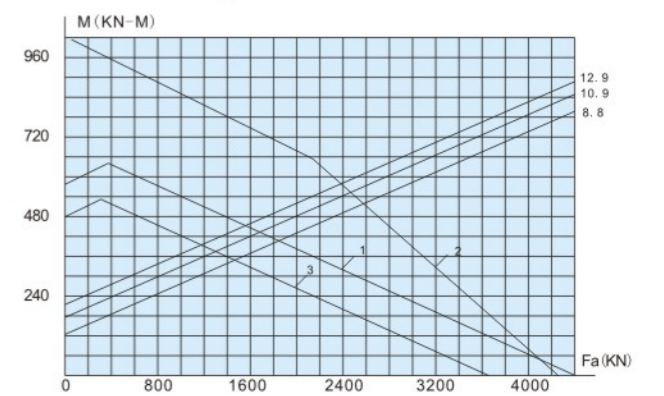

Fig. 4-94 131.25.710.12

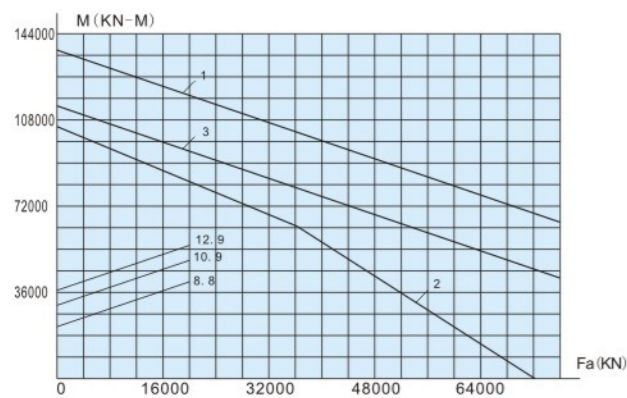

Fig. 4-87 3-931G

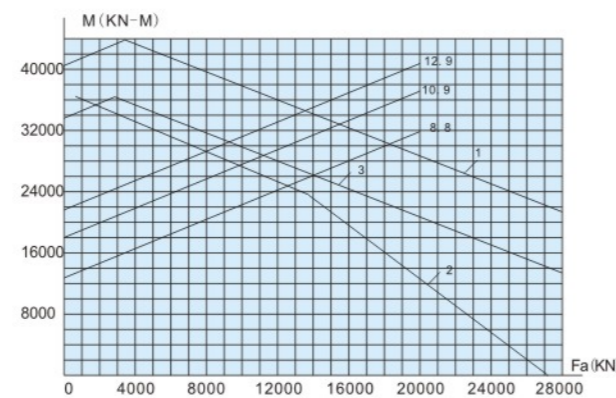

Fig. 4-88 5397/3735

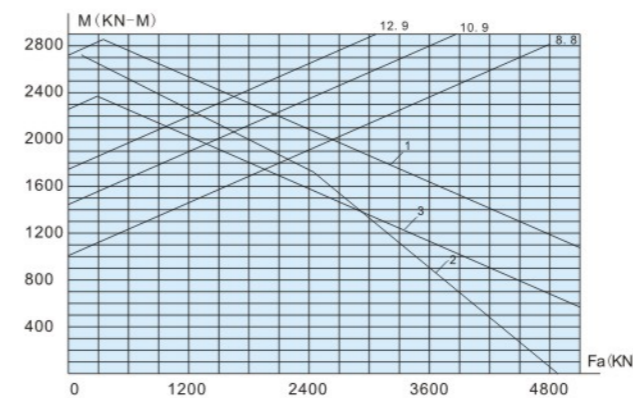

Fig. 4-95 6397/1453

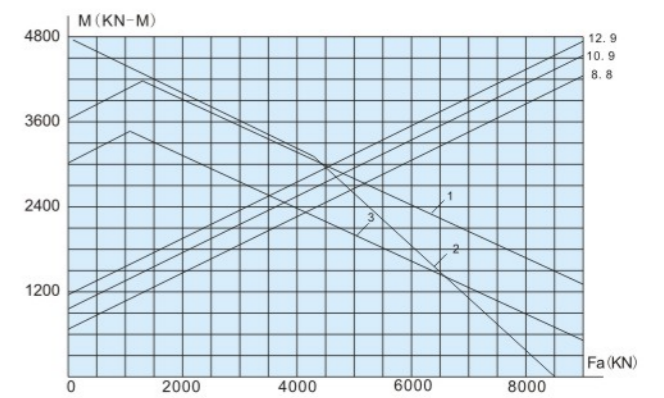

Fig. 4-96 6397/1545G2



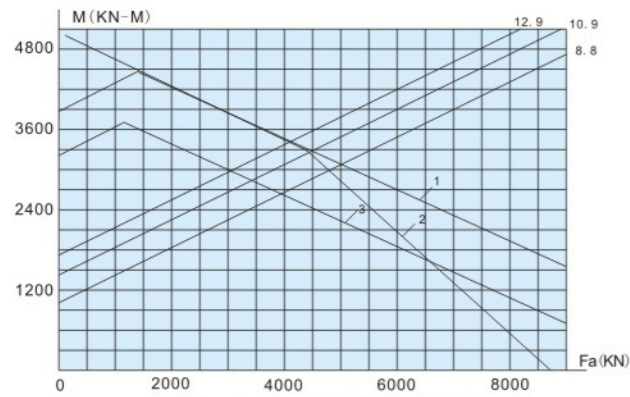

Fig. 4-97 6397/1600G2

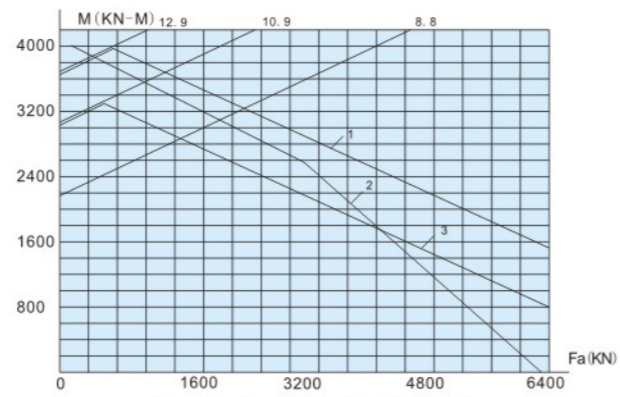

Fig. 4-98 131.25.1784.03

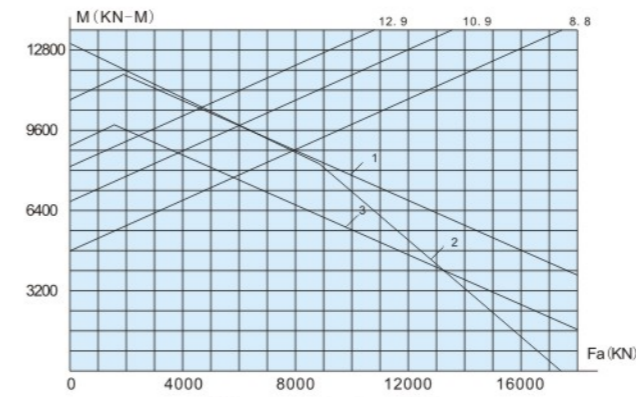

Fig. 4-105 3-947G

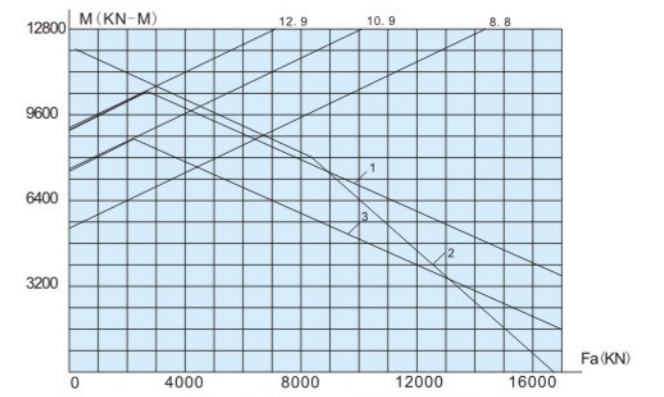

Fig. 4-106 6397/1990

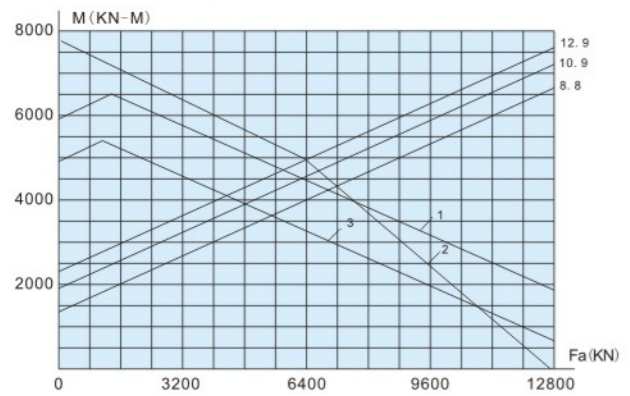

Fig. 4-99 6397/1605G2K

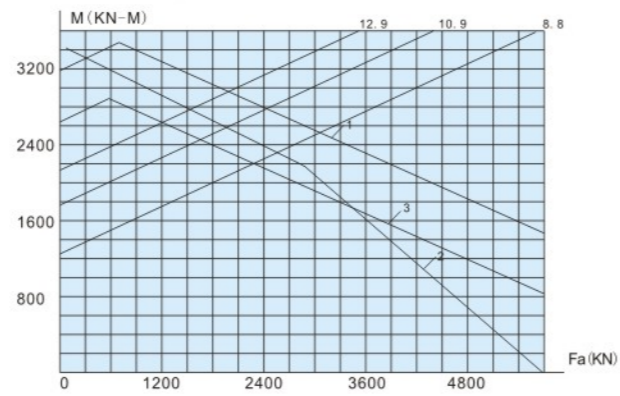

Fig. 4-100 131.22.1770.03

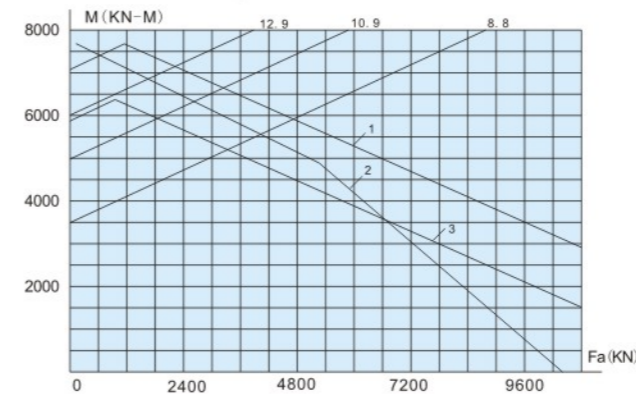

Fig. 4-107 6397/2001

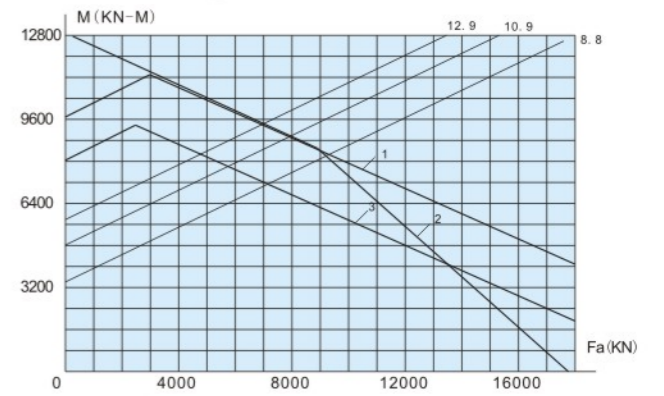

Fig. 4-108 132.45.2240.03

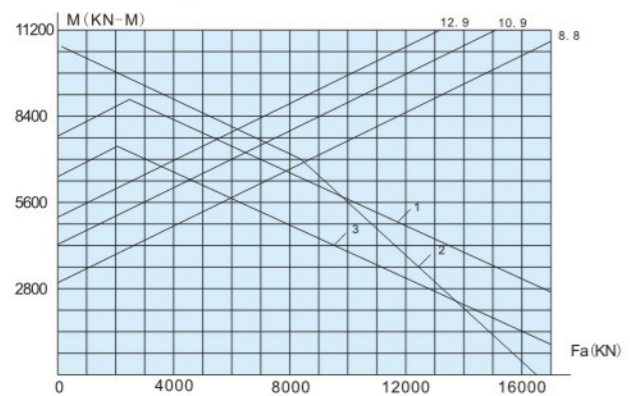

Fig. 4-101 131.45.2000.04

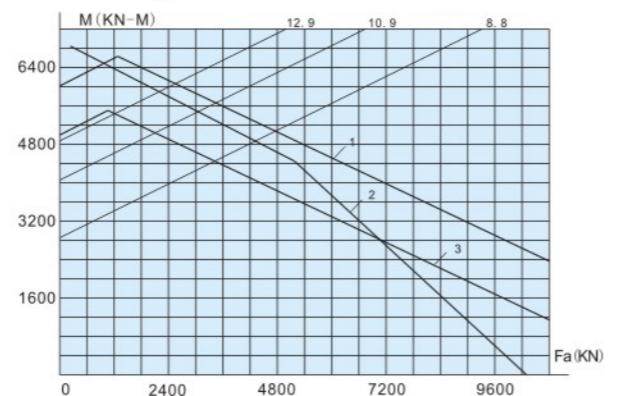

Fig. 4-102 131.32.2000.03

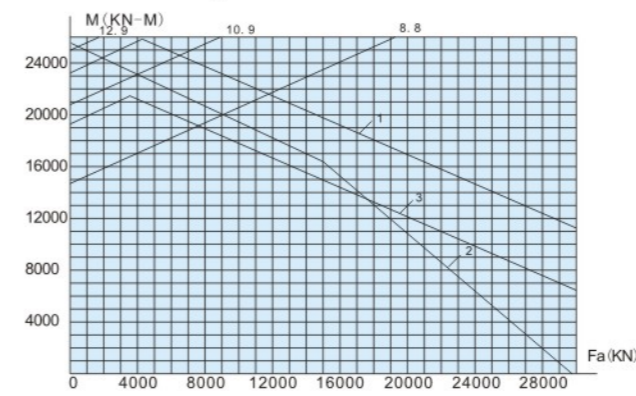

Fig. 4-109 132.50.2555.03

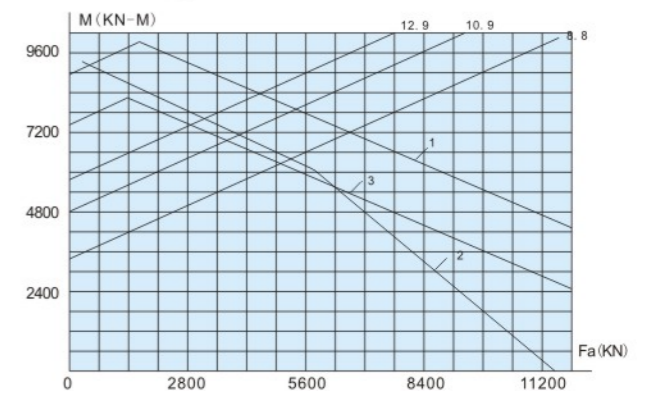

Fig. 4-110 3-934G

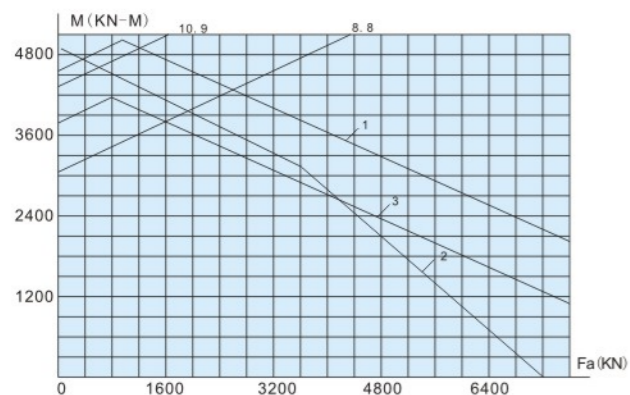

Fig. 4-103 132.25.2000.03

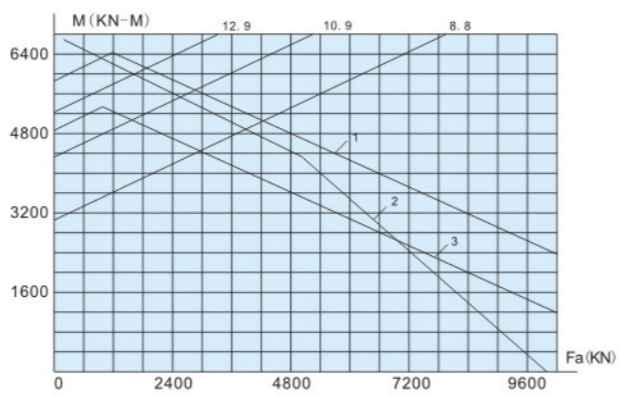

Fig. 4-104 132.32.2000.03

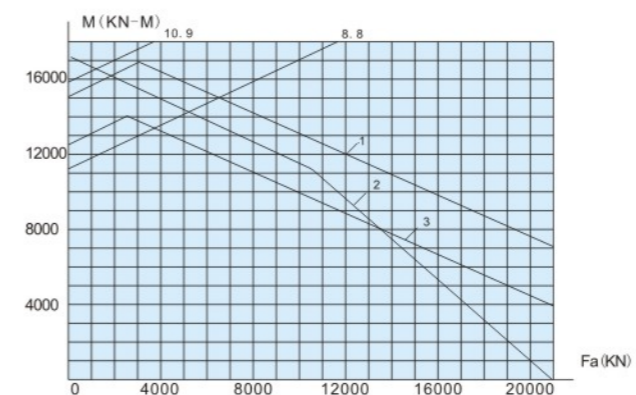

Fig. 4-111 131.45.2500.03K1

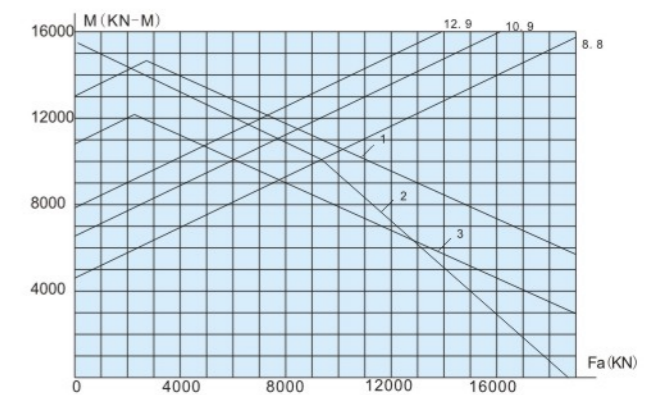

Fig. 4-112 131.45.2500.03



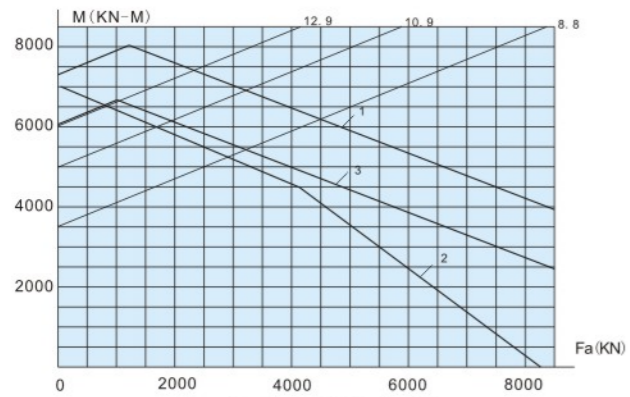

Fig. 4-113 6397/2319

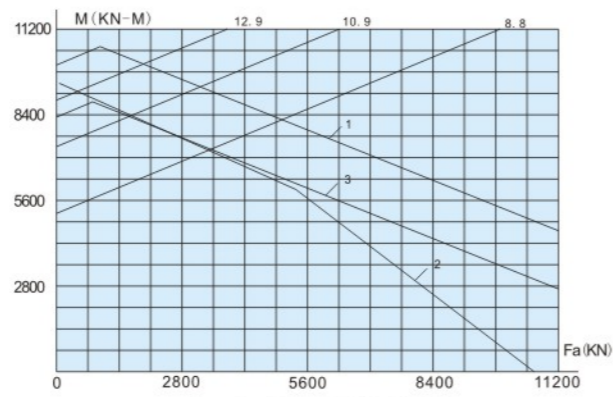

Fig. 4-114 6397/2369

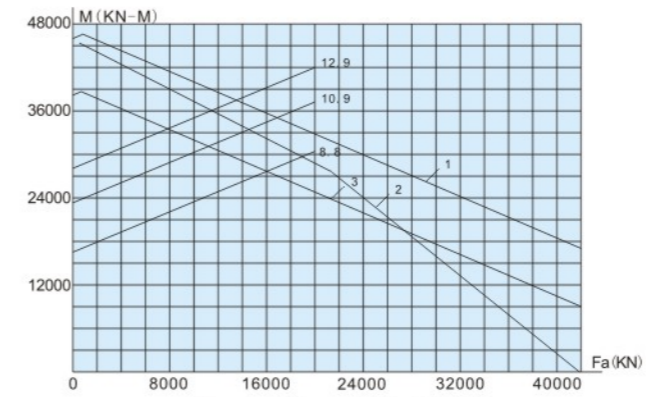

Fig. 4-121 6397/2669K

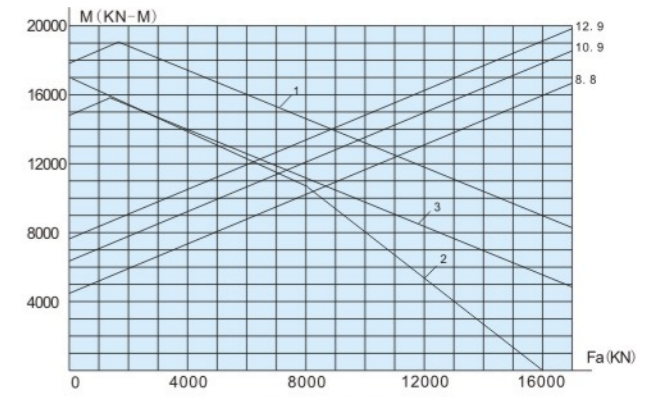

Fig. 4-122 6397/2800K

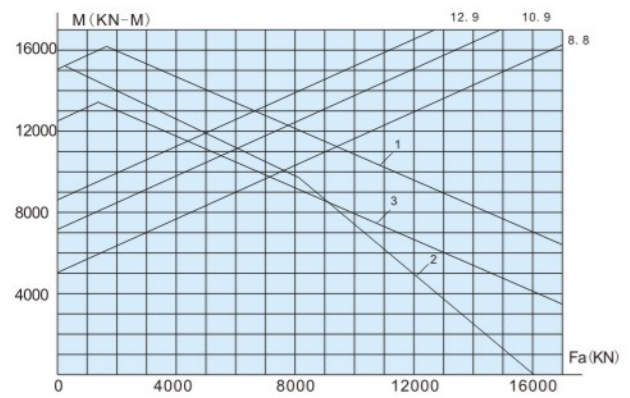

Fig. 4-115 131.40.2800.03

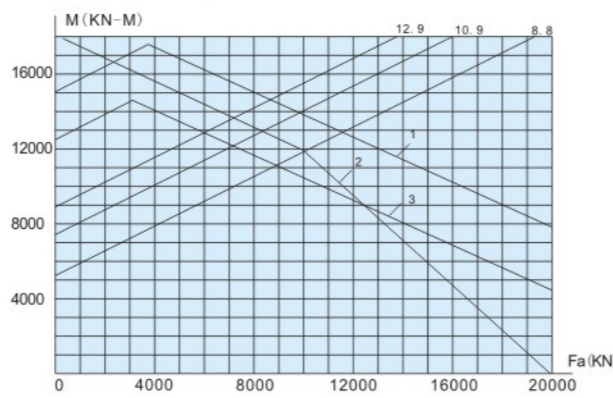

Fig. 4-116 131.45.2800.03

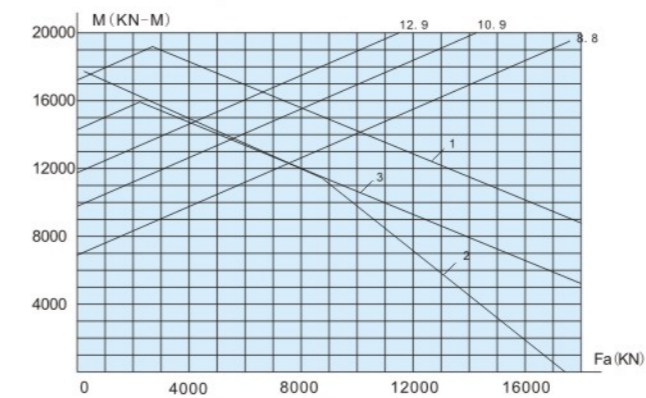

Fig. 4-123 6397/2800

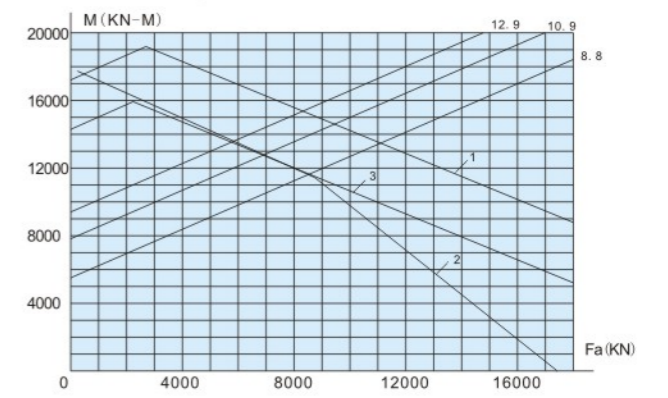

Fig. 4-124 6397/2800GK

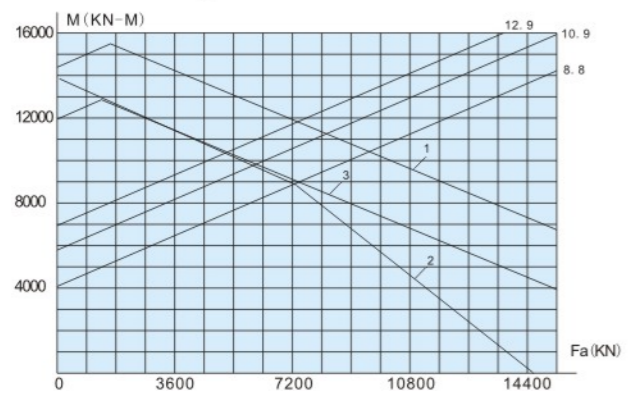

Fig. 4-117 6397/2585

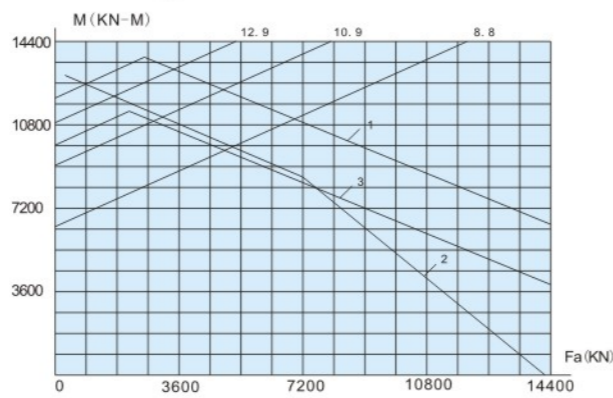

Fig. 4-118 6397/2590

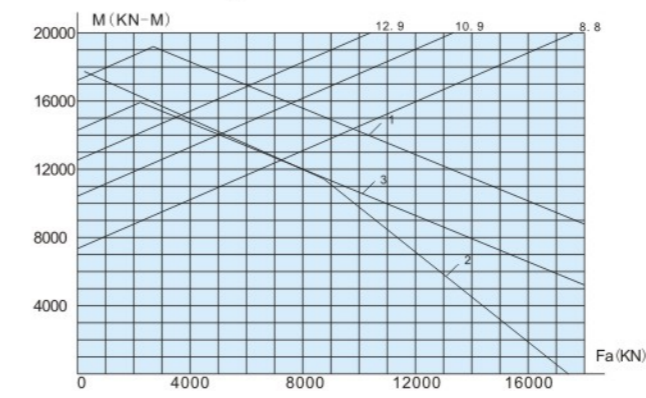

Fig. 4-125 6397/2800GK1

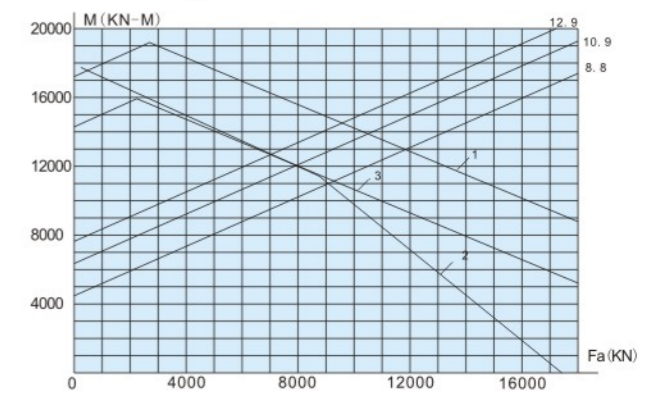

Fig. 4-126 6397/2800G2K1

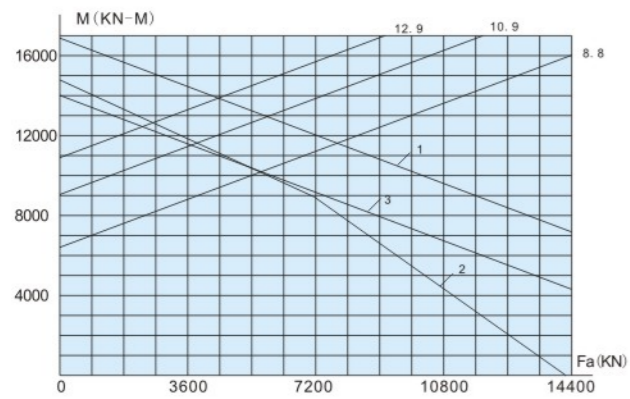

Fig. 4-119 6397/2590K

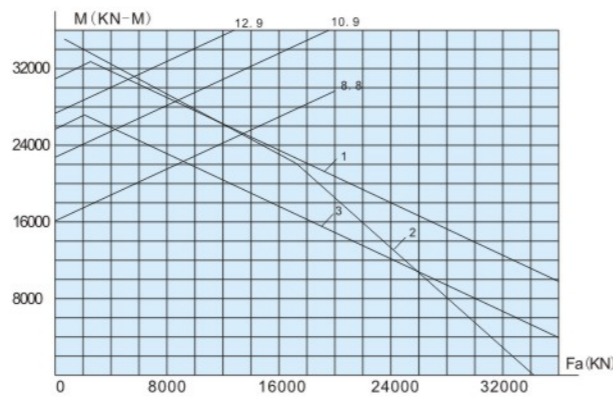

Fig. 4-120 6397/2599K1

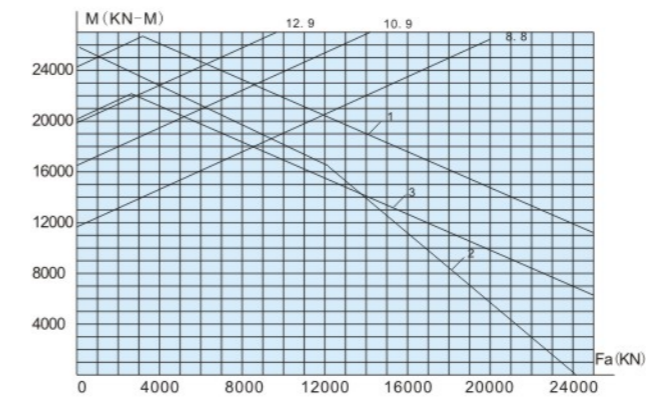

Fig. 4-127 131.50.3150.03

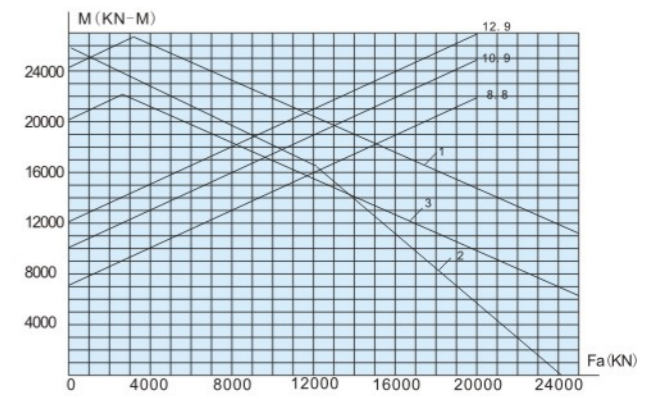

Fig. 4-128 131.50.3150.12K3



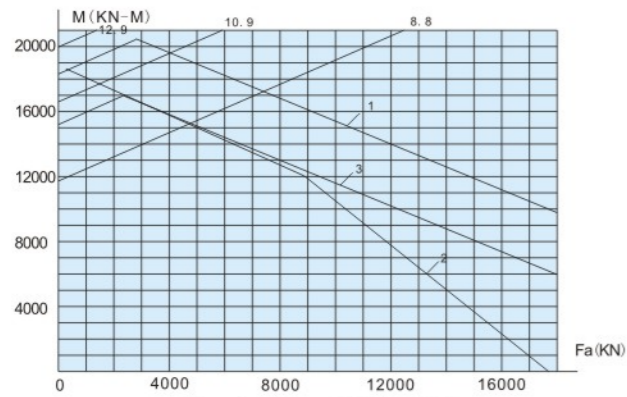

Fig. 4-129 6397/2885

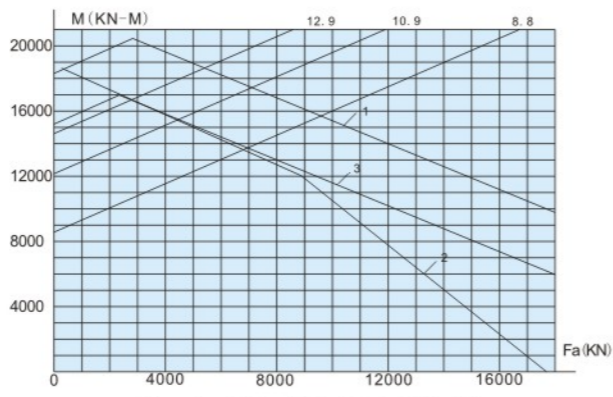

Fig. 4-130 131.40.3145.03

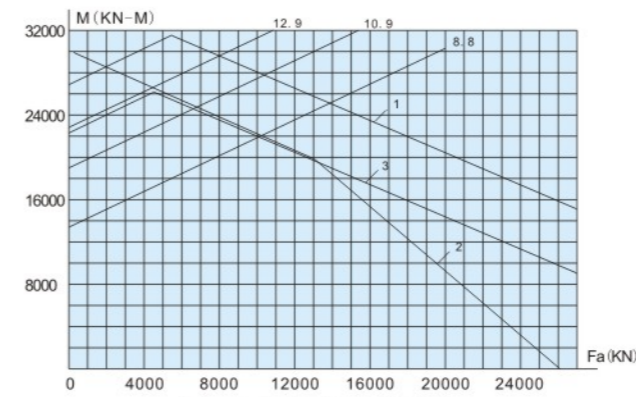

Fig. 4-137 6397/3292

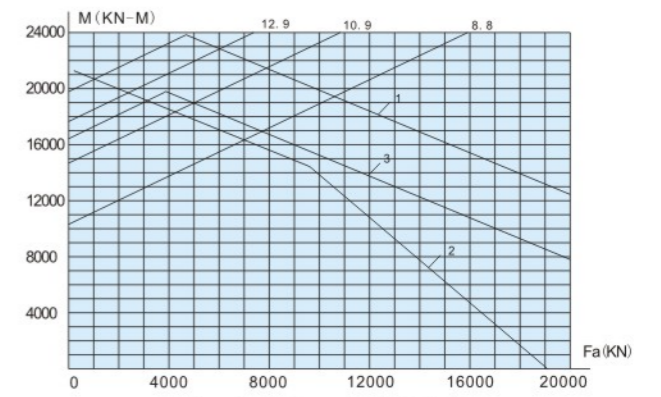

Fig. 4-138 6397/3340

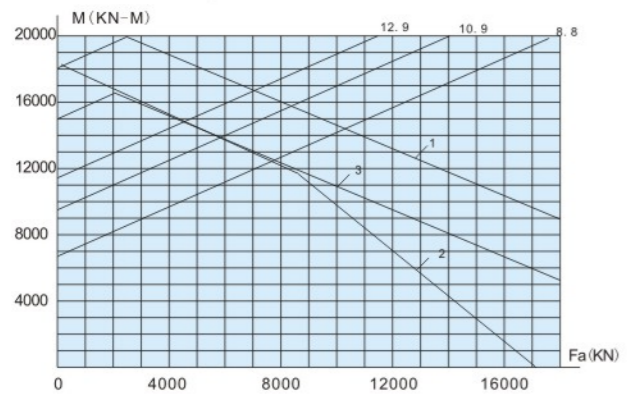

Fig. 4-131 6392/2910G

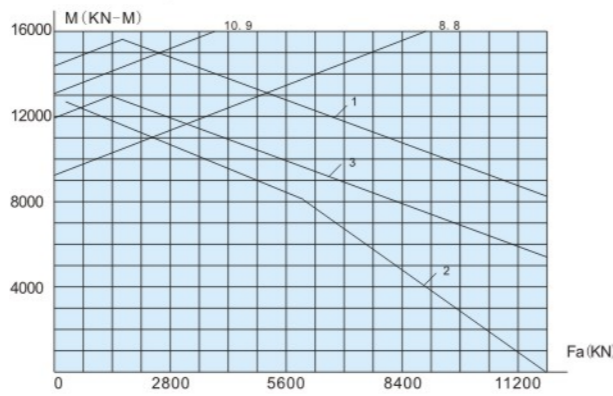

Fig. 4-132 131.30.3150.03

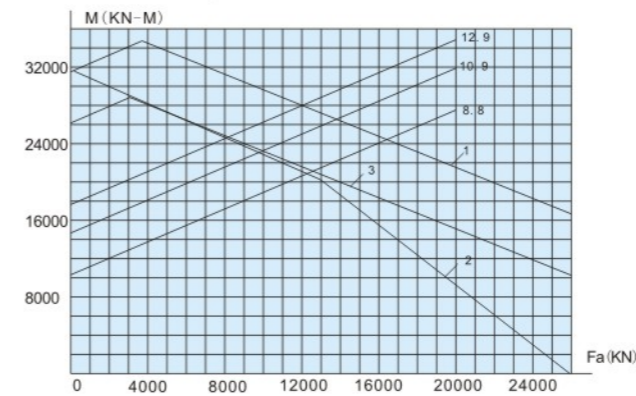

Fig. 4-139 131.50.3596.03

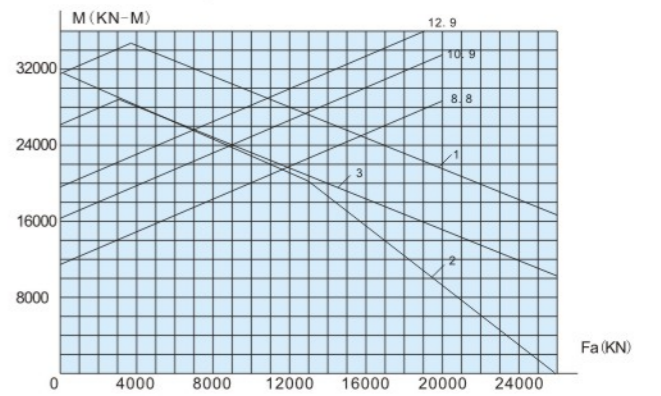

Fig. 4-140 131.50.3596.03K

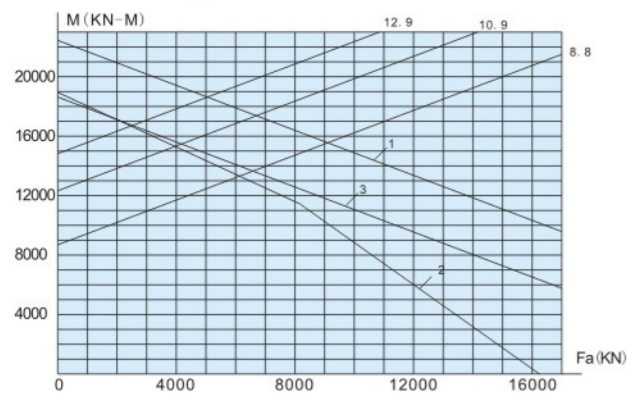

Fig. 4-133 131.38.3161.03

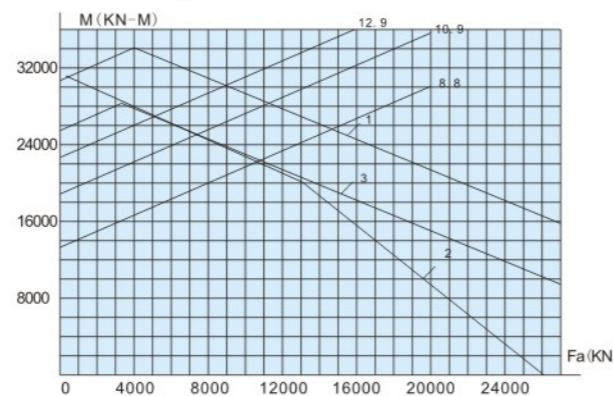

Fig. 4-134 131.50.3550.03

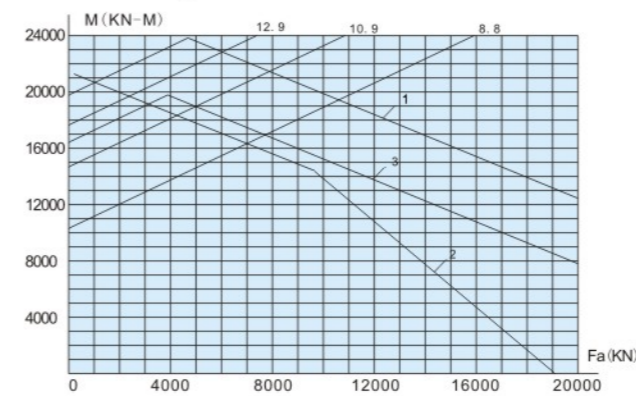

Fig. 4-141 132.40.3582.03K

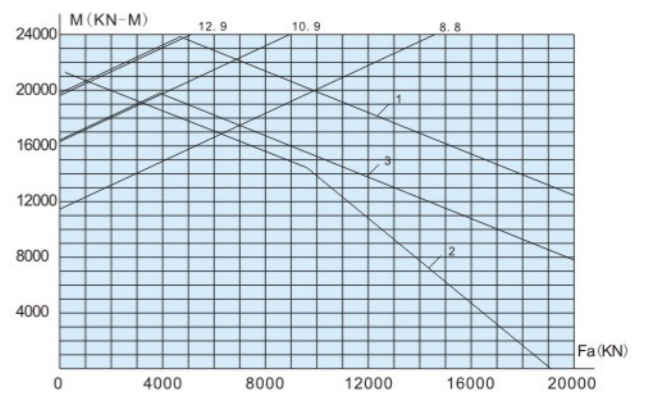

Fig. 4-142 132.40.3582.03

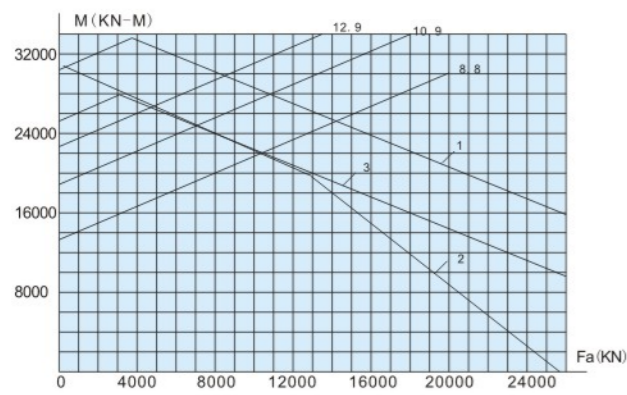

Fig. 4-135 132.50.3550.03K4

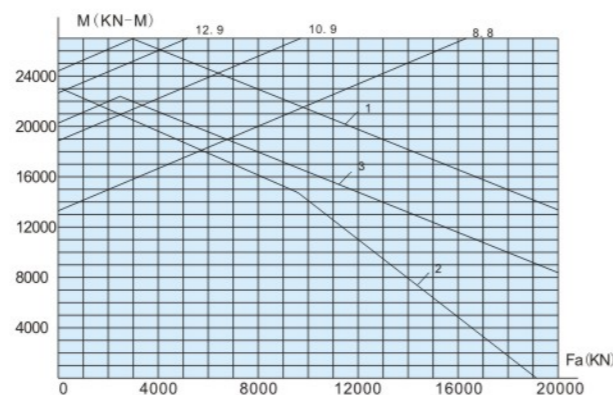

Fig. 4-136 132.40.3550.03

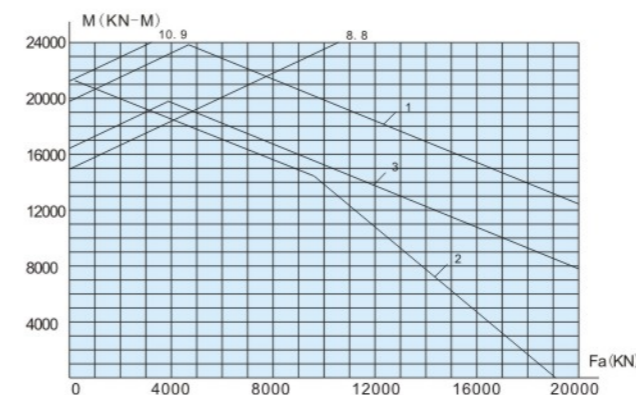

Fig. 4-143 132.40.3582.03K2

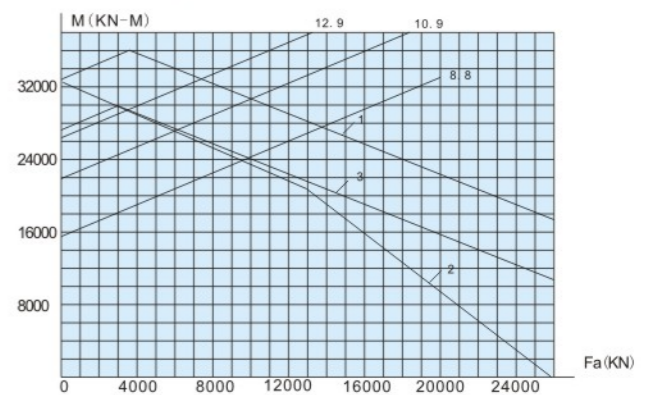

Fig. 4-144 6397/3415G2



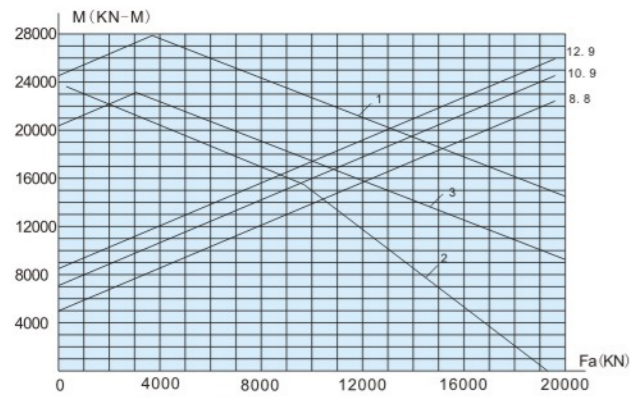

Fig. 4-145 132.40.3730.03

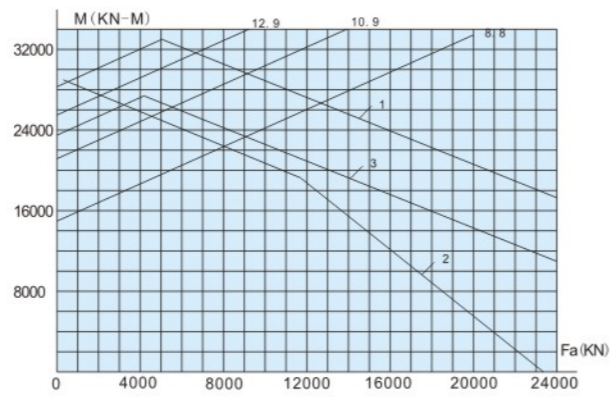

Fig. 4-146 6397/3615

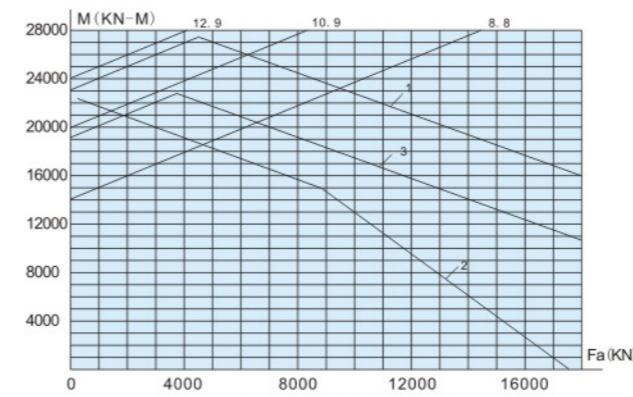

Fig. 4-153 6397/3780

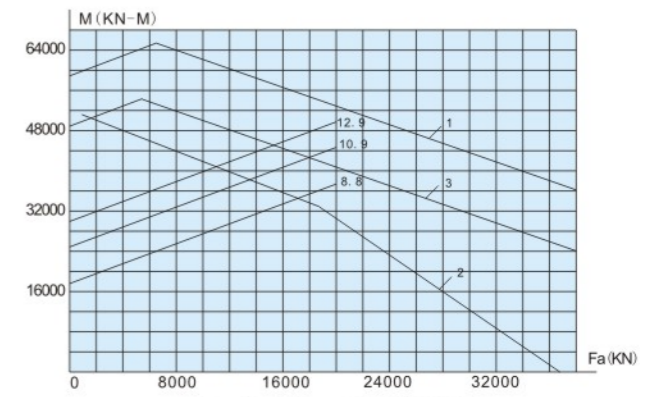

Fig. 4-154 6397/3870

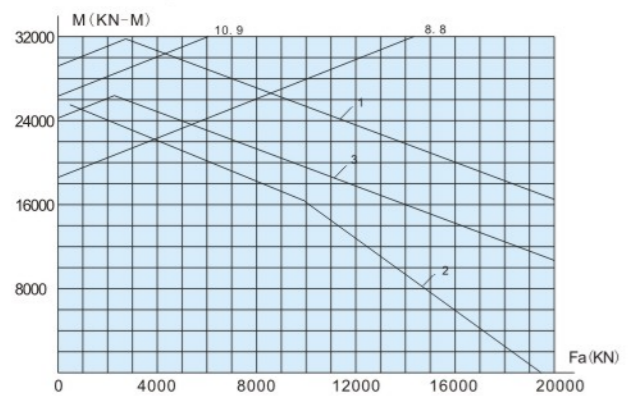

Fig. 4-147 6397/3650

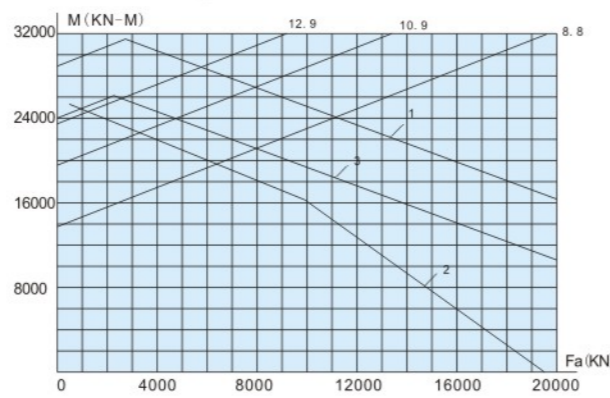

Fig. 4-148 6397/3630

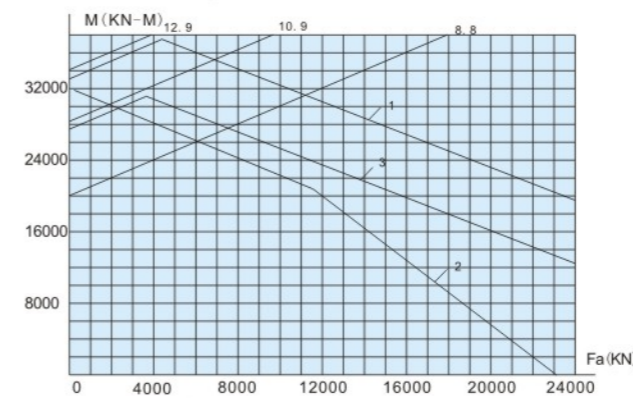

Fig. 4-155 6397/3925

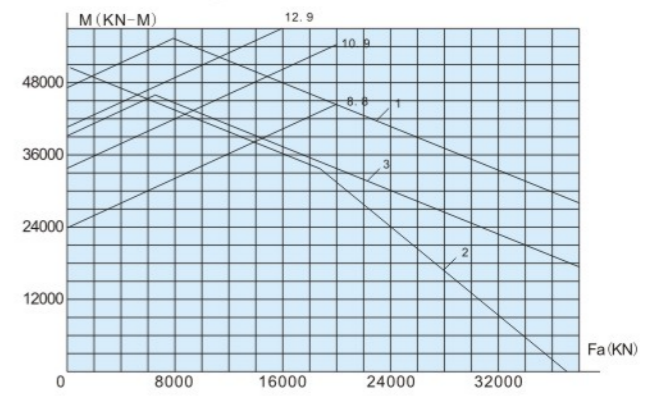

Fig. 4-156 6397/4016

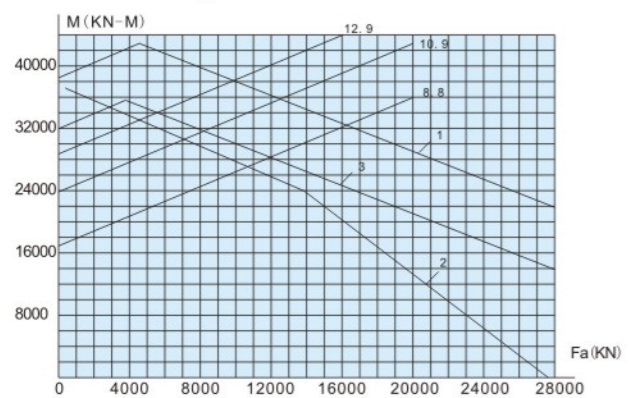

Fig. 4-149 131.50.4000.03K

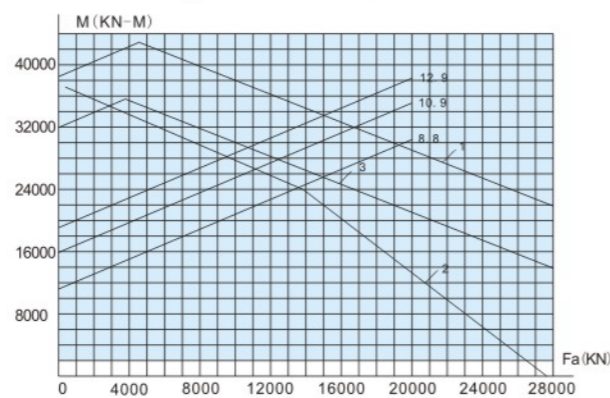

Fig. 4-150 131.50.4000.03K1

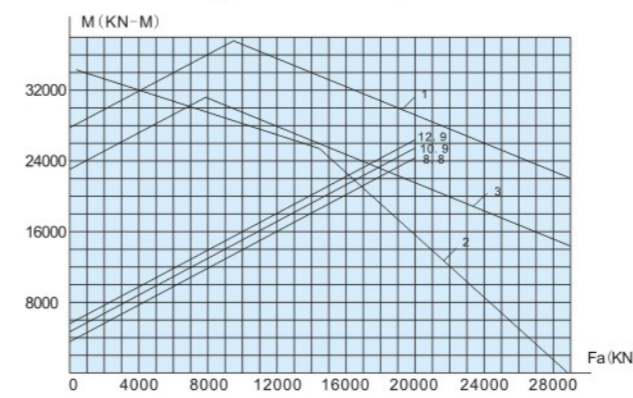

Fig. 4-157 6397/4100

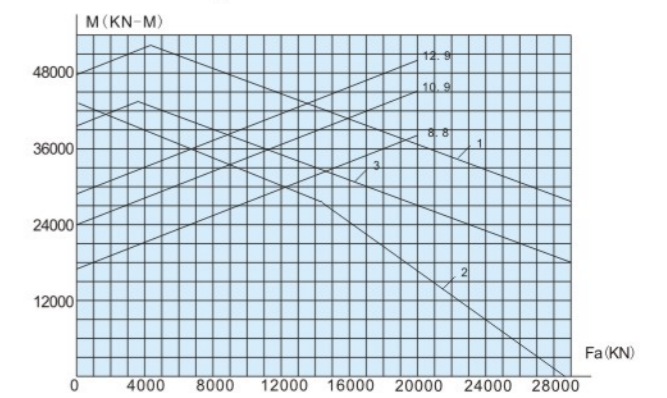

Fig. 4-158 132.50.4438.03

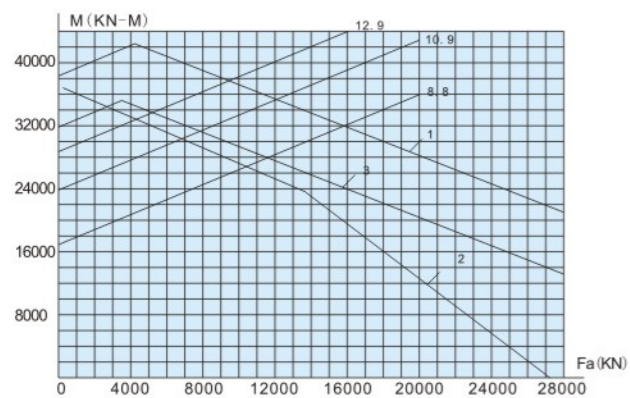

Fig. 4-151 131.50.4000.03

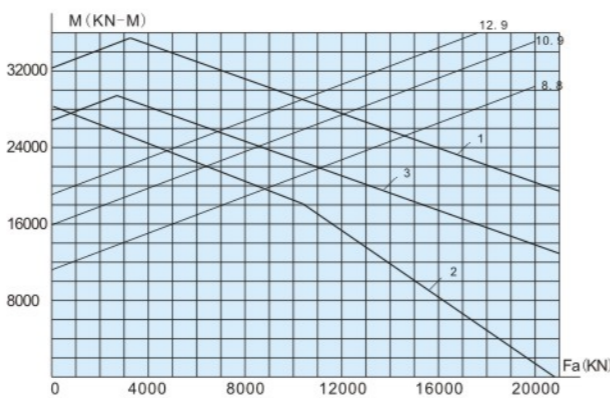

Fig. 4-152 132.40.4000.03

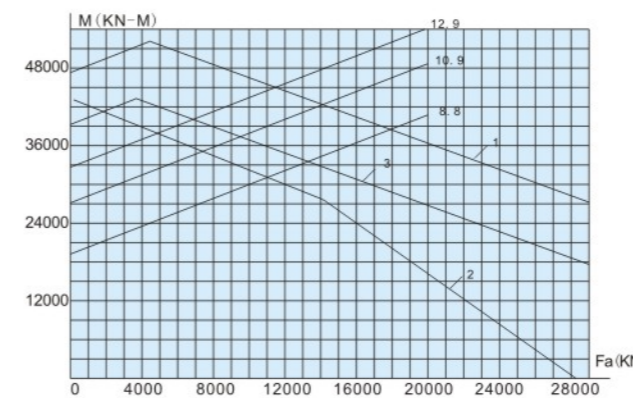

Fig. 4-159 131.50.4500.03

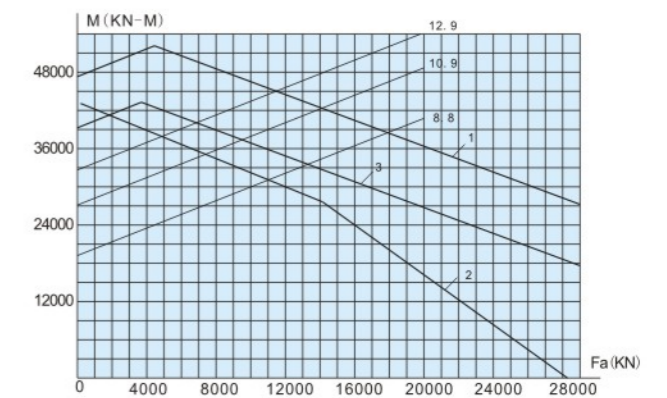

Fig. 4-160 132.50.4500.03



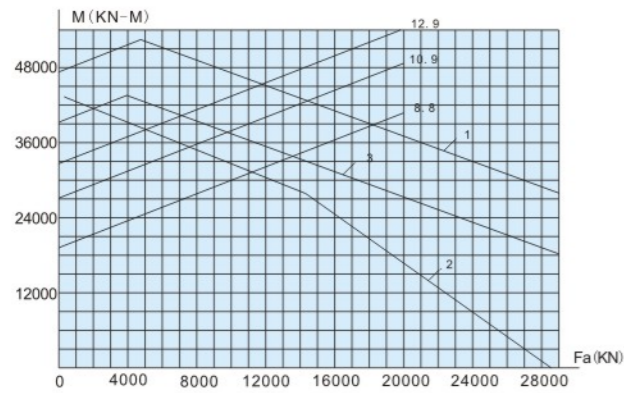

Fig. 4-161 132.50.4500.03K3

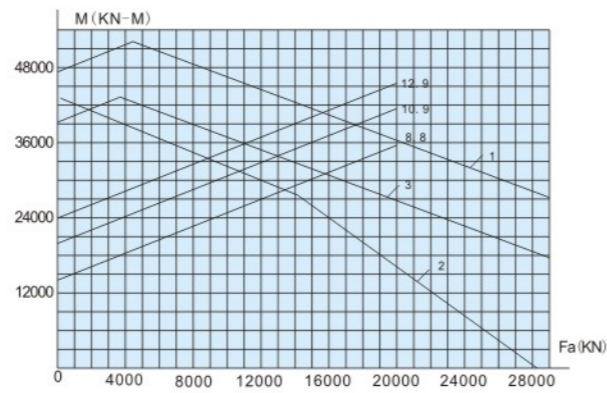

Fig. 4-162 132.50.4500.03K1

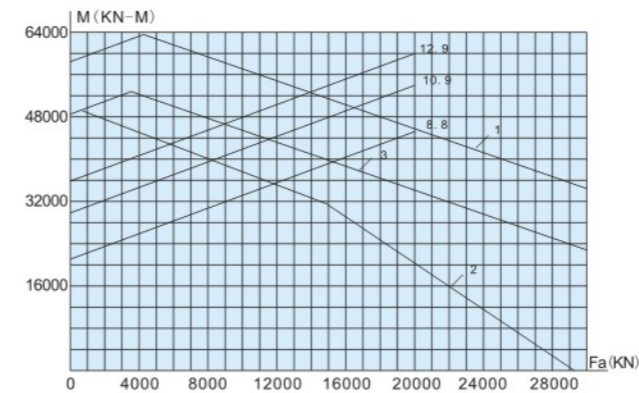

Fig. 4-169 132.50.5000.03K

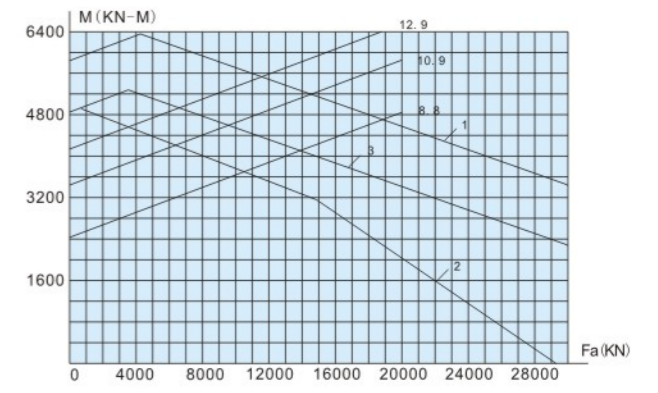

Fig. 4-170 132.50.5000.03K1

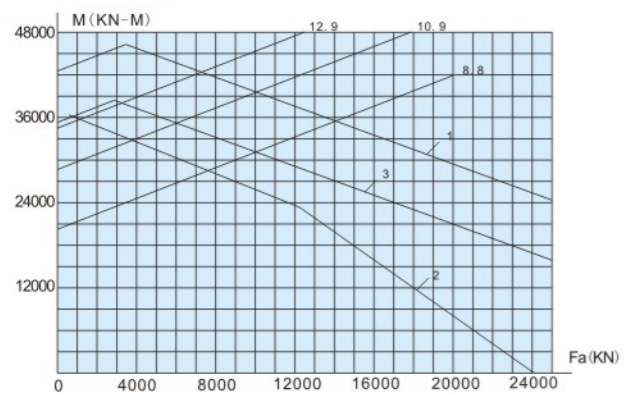

Fig. 4-163 6397/4246

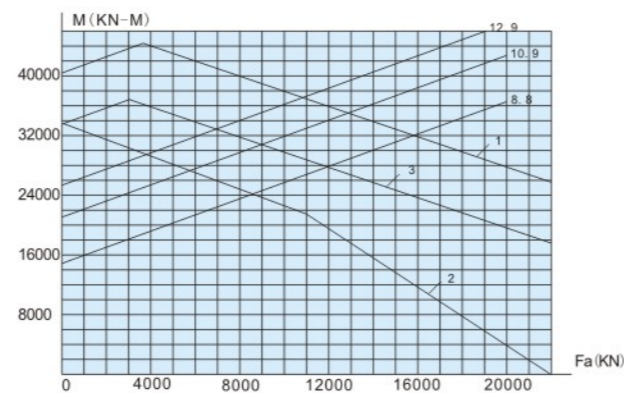

Fig. 4-164 131.40.4500.03

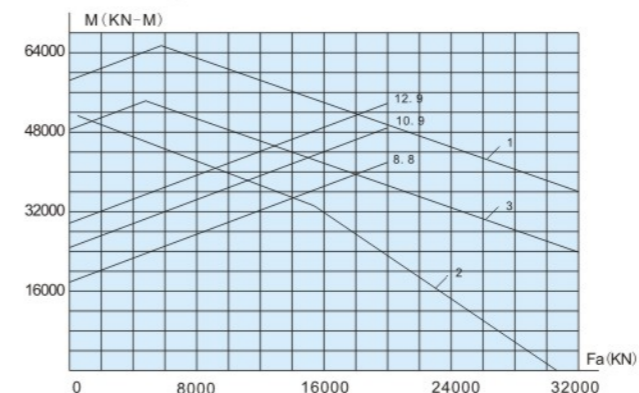

Fig. 4-171 6397/4747

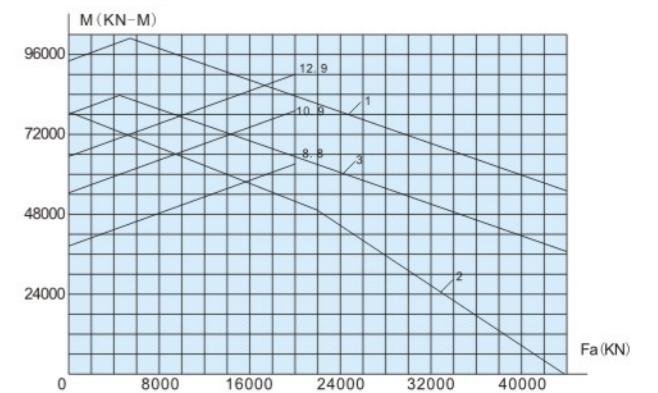

Fig. 4-172 6397/4830

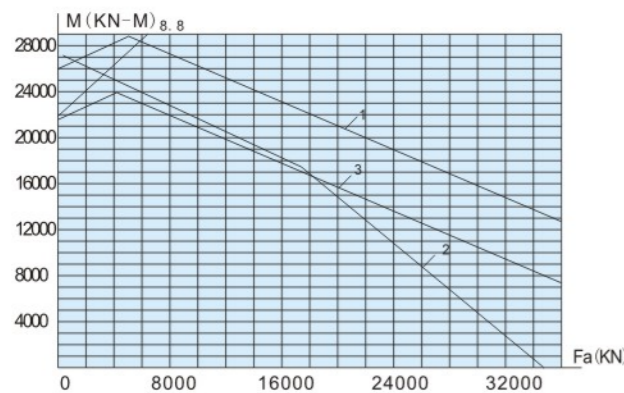

Fig. 4-165 6397/4375

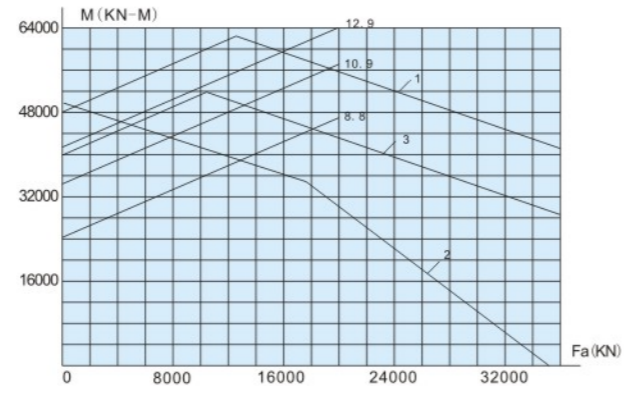

Fig. 4-166 6397/4440

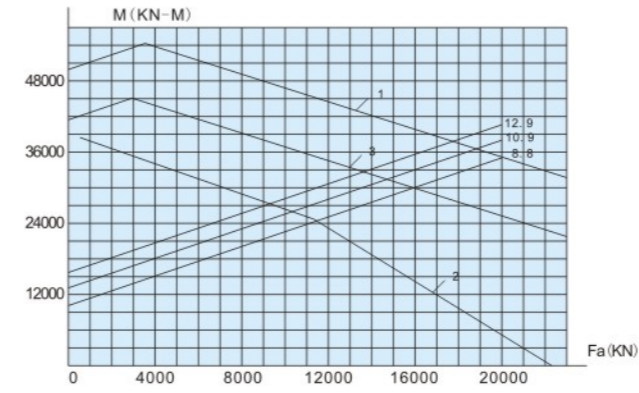

Fig. 4-173 6397/4914

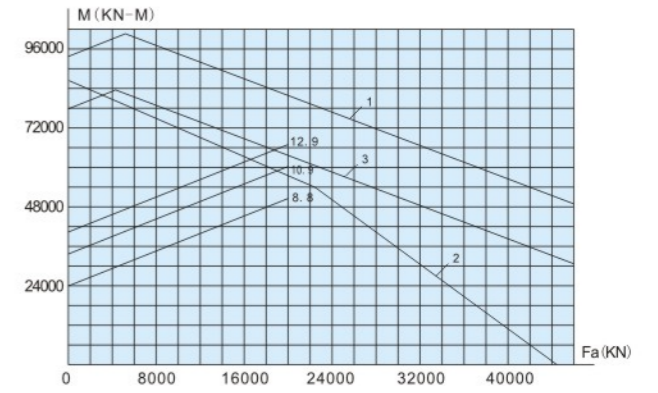

Fig. 4-174 131.70.5560.04

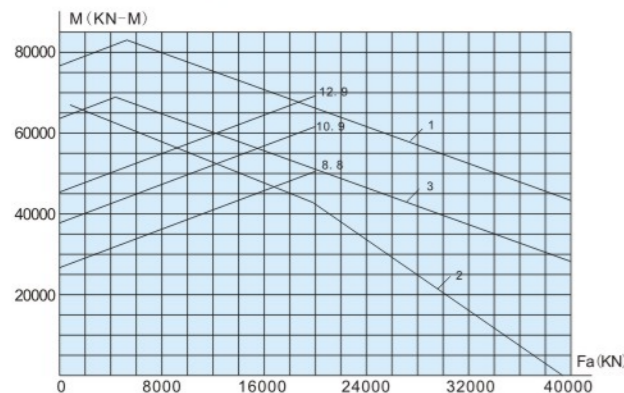

Fig. 4-167 131.60.5000.04

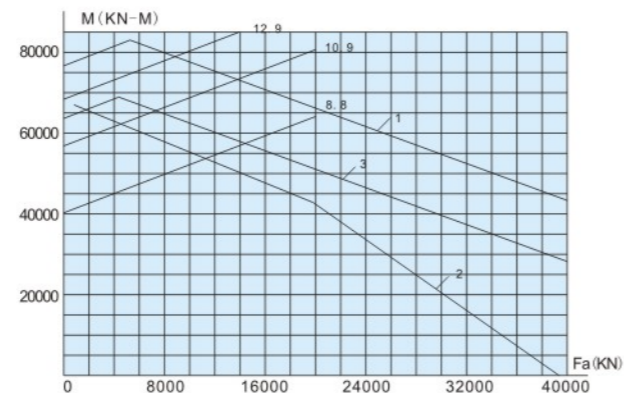
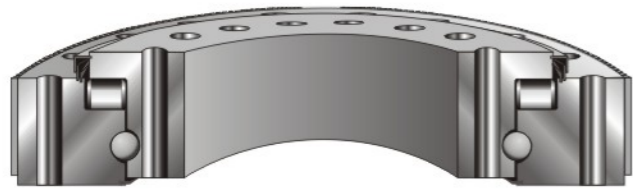

Fig. 4-168 132.60.5000.03K



## Double-Row Roller/Ball Combination Slewing Bearing



Type 221/222

▲ The design's of all these slewing rings are based on standard structures; LYC can design and manufacture many other similar structures in accordance to the special and particular requirements of their customers'. If our customer's have specific requests then the customer should identify the structure, and mounting dimensions that are required. Please contact the LYC Technical Center if you need any assistance in this area.

## Double-Row Roller/Ball Combination Slewing Bearing

LYC double-row roller/ball combination slewing bearing can carry axial load, tilting moment and radial loads at the same time. The top roller mainly carries the axial load and positive tilting moment. The drop ball takes the opposite tilting moment. This is the reason for the loading capacity of the roller/ball combination slewing bearing being larger than the double-row ball slewing bearing, however, the frictional resistance is much larger than the latter. Generally double-row roller/ball combination slewing bearing has advantage of large load carrying capacity and low frictional resistance.

LYC double-row roller/ball combination slewing bearing consists of a inner ring, outer ring, one row balls, one row rollers spacers, sealing device, and other components. In order to

accommodate the various working condition at different axial load, tilting moments and axial load, the angle of contact on drop row balls would be adjusted accordingly.

The rings structure can be divided into two types, integral type and split type. Generally, the integral type maintains a stronger rigidity. The split type is more convenient to adjust; the two segregate rings are fastened by bolts prior to delivery.

LYC double-row roller/ball combination slewing bearing has cages (or spacing blocks) among the balls. Only when large loading is requested would the full ball type be applied. Loading capacity for full ball type is definitely larger. However, the increased friction generated by this

design allows for the balls to be easily scratched.

The double row slewing bearing is mainly for the working conditions when carrying an axial load, larger tilting moment and low frication resistanc.

The basic structure of LYC double-row roller/ball combination slewing bearing as below:

- Without gear (Type 220)
- External gear (Type 221/222)
- Internal gear (Type 223/224)

● For dimension and related data of LYC double-row roller/ball slewing bearing, please refer to double-row ball slewing bearing section.

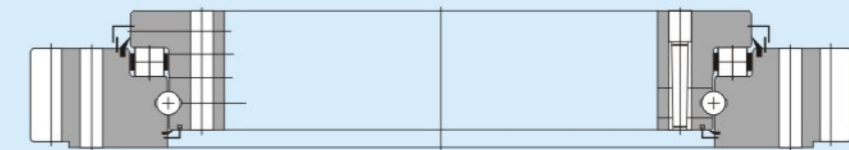

Type 221/222



### Double-Row Roller/Ball Combination Slewing Bearing-with External Teeth

d576~2868mm

Boundary Dimension			Bearing Type	Related Dimension										
d	D	T		D1	d1	d2	Dwp	H	h	n1	n2	n3	φ1	φ2
mm			mm											
2567	2973	176	221.32.2750.03	2908	2619	2795	2750	143	50	8	52	52	M10x1	26
4542	—	175	221.36.4750.03	4851	4608	4801	4750	159	50	15	90	90	M10x1	33
3508	3918	230	221.40.3750	3845	3560	3804	3750	175	55	8	80	80	M10x1	26
4978	5477	237	221.45.5200.03	5389	5044	5261	5200	187	50	15	90	90	Rp1/4	33
4280	4880	280	221.50.4600	4800	4360	4668	4600	260	70	10	60	60	Rc1/4	39

#### Loading Curve

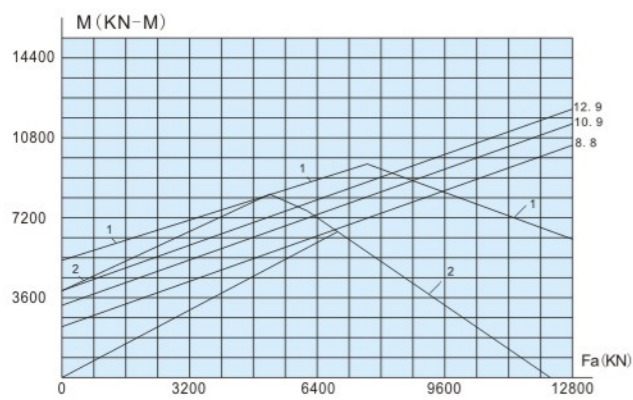

Fig. 5-1 221.32.2750.03

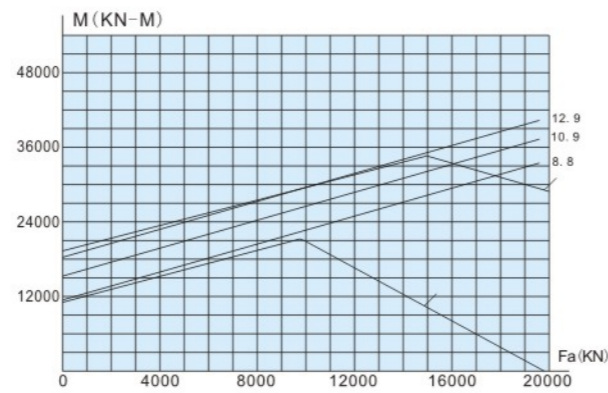

Fig. 5-2 221.36.4750.03

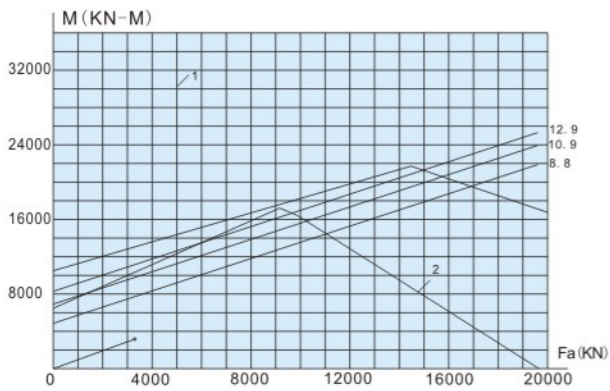

Fig. 5-3 221.40.3750

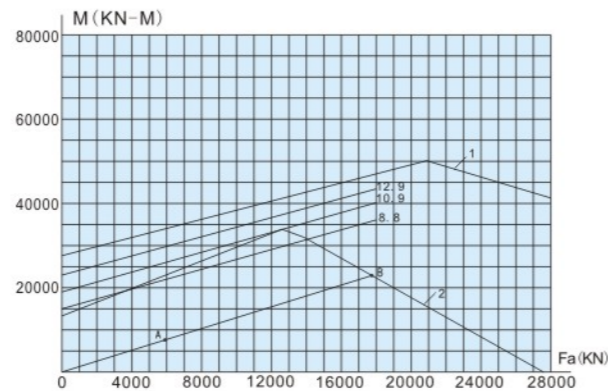

Fig. 5-4 221.45.5200.03

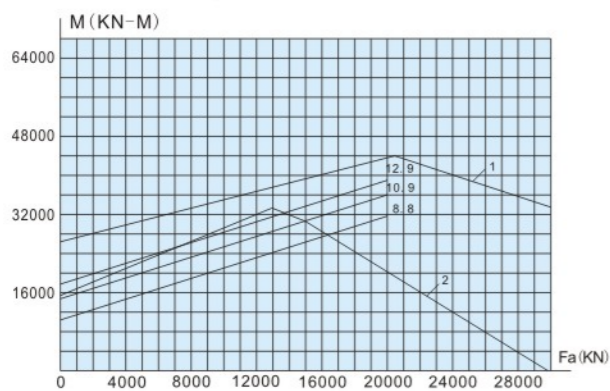
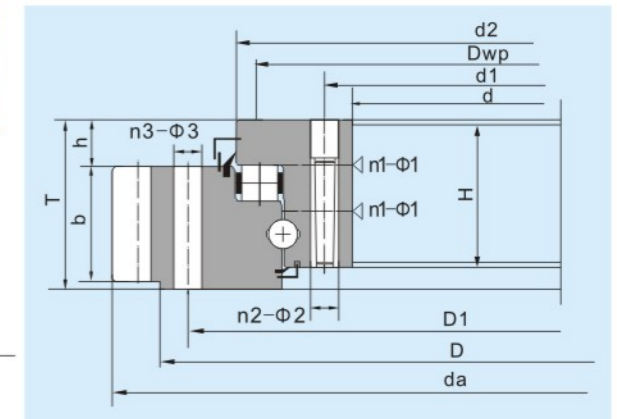

Fig. 5-5 221.50.4600

φ3	Gear Parameter					Weight	Loading Curve
	da	b	m	Z	x		
						kg ≈	
26	3056.4	125	18	167	0.5	2025	
m30	5000.4	125	18	275	0.5	3349	
m24	4027.2	174	24	165	0.5	3804	
33	5587.2	186	24	230	0.5	6616	
39	4998	200	25	197	0.5	8500	





LYC's Series Catalogues & Brochures Listed to Help for Your Selection



LYC Web Site : [www.lycbearing.com](http://www.lycbearing.com)

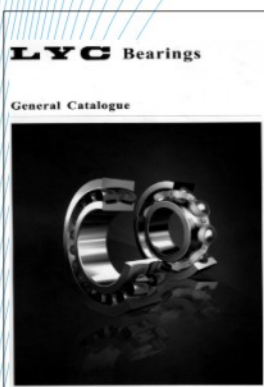

General Catalogue



Slewing Bearing Catalogue



Insert Bearing Catalogue (coming soon)



E-Catalogue and Presentation Video

Brochures Listed



Bearings for Cement Equipment



YRT Bearings



Rolling Mill Bearings



Vehicle Bearings



Railway Bearings



Bearing Failure Cause and Measure



Windturbine Bearings



Machine Tool Precision Bearings



General Introduction



Slewing Bearing Installment Instruction



Rolling Mill Bearing Installment Instruction

If request any related information, please go [www.lycbearing.com](http://www.lycbearing.com) to download or contact our sales rep. to get it.



Attachment—Information Request for Bearing Selection

Equipment Name					Type of Main Power Unit			
Working Condition		Axial Load (kN)	Radial Load (kN)	Tilting Moment (kN·m)	Running Speed (rpm)	Working Time (%)		
Load	Static Max:							
	Test:							
	.....							
	Dynamic Max:							
	Test:							
	Over Load:							
Vibration & Impact Degree		Slight: Medium:		Severe:				
Application	Service Life (h)							
	Installation Method	Horizontally: seated or suspended			Vertically:		Others:	
	Usage Mode	Continuous:		Interval:	Swing:		Others:	
	Rotating Part	Outer ring:			Inner ring:			
	Lubrication Method	Grease:		Oil:		Others:		
	Seals	Host settings:			Bearing Settings:			
	Bearing Driving Peripheral Force	N						
	Environmental Condition	Humidity(%):		Temperature(°C):		Pollution:		
Bearing Working Temperature	°C							
Bearing Parameters	Structural Type	01:	02:	11:	13:	Others:		
	Boundary Dimensions	Outer Diameter (mm) :		Inner Diameter (mm) :		Overall Height (mm) :		
	Ring Material Requested	50Mn:		42CrMo:		Others:		
	Transmission Type	Without Gear:		Internal Gear:		External Gear:		
	Friction Moment	Starting: (N·m)		Rotating: (N·m)				
	Clearance	Axial:		Radial:				
	Precision Grade							
	Requirement for Anticorrosion							
	Mounting Hole		Center Circle diameter (mm)		Diameter of Mounting hole × Quantity		Diameter of Oil Hole × Quantity	
		Inner Ring						
Outer Ring								
Dimension of Spigot Drive (mm)	Outer Ring:			Inner Ring:				
Parameter for Gear		Pinion			Bearing Gear Ring			
	Number of Teeth				Number of Teeth			
	Module				Module			
	Tooth Width				Tooth Width			
	Press Angle				Press Angle			
	Modification Coefficient				Modification Coefficient			
	Precision Grade				Precision Grade			
	Addendum Coefficient				Addendum Coefficient			
	Heat Treatment Condition of Gear				Heat Treatment Condition of Gear			
	Center Distance of Gear	Adjustable:			Not Adjustable:			
Other Requirement	1、Sketch Drawing of Bearing Load							
	2、Sketch Drawing of Bearing Installation							
	3、Others							



**LYC**<sup>®</sup>

■ LYC Import & Export Corp.(Head Office)

Add:96 jianshe Road,Jianxi district,  
Luoyang, Henan, China

Tel:+86-379-64984176

Fax:+86-379-64912225

Web site:<http://www.lycbearing.com>

■ LYC North America Inc.(Subsidiary,USA)

2600 Keslinger Road Unit H

P.O.Box 150

Geneva IL 60134 USA

Tel:630-262-0601

Fax:630-262-0638

Email:[sales@lycbearings.com](mailto:sales@lycbearings.com)

[Http://www.lycbearings.com](http://www.lycbearings.com)